

Foster 
Catalogue

Foster 



fosterspa.com

The world of Foster
a better world for future generations



18	PVD
92	Top-mount sinks
204	Undermount sinks
286	Complements
306	Mixer taps
342	Equipped troughs
362	Induction hobs
394	Gas hobs
434	Ovens
456	Hoods
478	Dishwashers
484	Stainless steel worktops



Foster

RESEARCH, DESIGN and TECHNOLOGY all in one sign, the Foster brand.

The desire to always find new solutions to improve the quality of life in the kitchen is the engine of our research, the reason for our satisfaction.

We have reached important milestones in the development of household appliances and every day, with the same enthusiasm, we share and develop ideas with the most important kitchen manufacturers in Italy and worldwide.

This is Foster philosophy: excellence in quality standards, great manufacturing craftsmanship in the processing of materials, ever innovative solutions interpreted with our signature style and taste

Foster and the local area

inspired by
Art and Culture



Founded in 1973, Foster is an Italian company with four manufacturing plants, operating in more than 50 countries worldwide. It is an integrated organization based in the historic Terranova Palace in Brescello, a small village known for the movies starring Don Camillo and Peppone and a symbol of the industriousness of the countryside of Northern Italy.

Terranova Palace is both the Headquarters and the expression of Foster love for art.

Foster established its headquarters here in 1988, after the restoration of the former 17th-century Franciscan convent. The restoration brought back splendour to the prestigious frescoes and unveiled ancient historical artefacts.

The Terranova Palace is a cultural heritage that the company presented to the local community in all its history, beauty and magnificence. Foster has been among the first Italian companies to join projects for the safeguarding and protection of the environment, and the building is now under the protection of the Superintendence for Architectural and Landscape Heritage



Foster

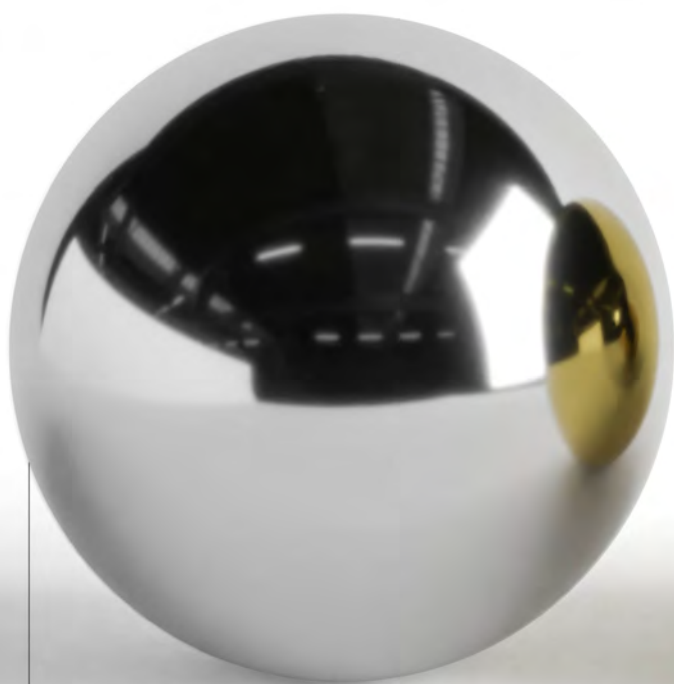

...research

Every Foster product is the result of extensive research and a constant process of innovation. We work tirelessly to develop stainless steel technology using high-quality materials such as AISI 304 and AISI 316.

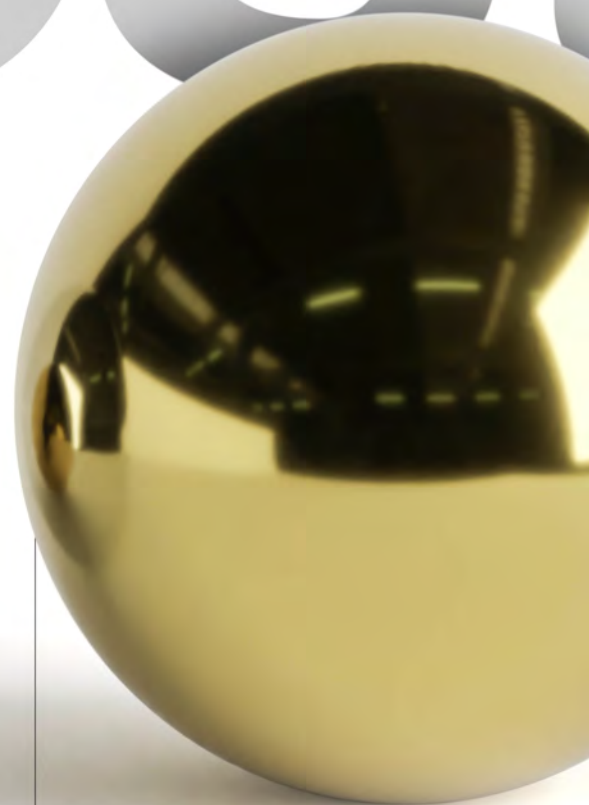

...design

Every Foster appliance is a work of art, created with a meticulous attention to detail. Stainless steel, with its timeless brilliance, matches any kitchen style perfectly, lending a touch of elegance and sophistication to every environment.

ter



...technology

Foster doesn't stop at aesthetics alone. Every product is designed to enhance your dining experience. Our appliances have state-of-the-art features to ensure flawless performance and are easy to use. Hence the kitchen becomes an environment where creativity is combined with the utmost efficiency. Welcome to the world of Foster: Research, Design and Technology.

Foster and steel

a story
of excellence



For more than half a century Foster has been sharing its passion and dedication in the art of shaping AISI 304 and AISI 316 stainless steel, the heart and soul of our creations.

More than just Raw Material. Our know-how goes beyond selecting raw materials: Every step of the manufacturing process, from assembly to the finishes, stems from years of experience in the art of shaping steel with the aim of achieving perfection in every detail. The skilful use of AISI 304 and AISI 316 is our signature, a guarantee that every Foster product is an extraordinary combination of beauty and functionality. Welcome to the world of Foster, where steel is turned into a story of excellence.

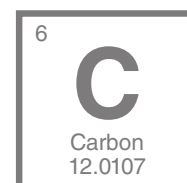
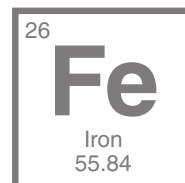



AISI 304 - Standard Excellence:

Our extensive know-how in the use of AISI 304 stainless steel is the secret of our success. This material, with its chromium and nickel content, is synonymous with corrosion resistance, durability and high tolerance to extreme temperatures. Also known as 18-10 stainless steel (18% chrome and 10% nickel), AISI 304 is the starting point for creating products that are sturdy, long-lasting and non-porous. The smooth and hygienic surface of AISI 304 steel is easy to clean and retains its brilliance over the years.

AISI 316 - The Solution for Extreme Challenges:

The use of AISI 316 steel, known for its exceptional resistance to corrosion in harsh environments. Originally developed for the nautical sector, AISI 316 is resistant to the effects of salt, aggressive detergents and food acids. This unique material is used in a complete line of Foster products suitable for the most demanding environments and challenges.





Stainless steel

a timeless
ecological choice



**AISI
304**

The use of **304** and **316** steel offers countless advantages, starting with the strength and durability that makes stainless steel the resistant material par excellence.

As it is easy to clean, using less water and fewer chemicals, and it can be recycled countless times, stainless steel is a truly sustainable and environmentally friendly material.

**AISI
316**

100% recyclable
High hygiene level
No toxic emissions
Unaffected over time

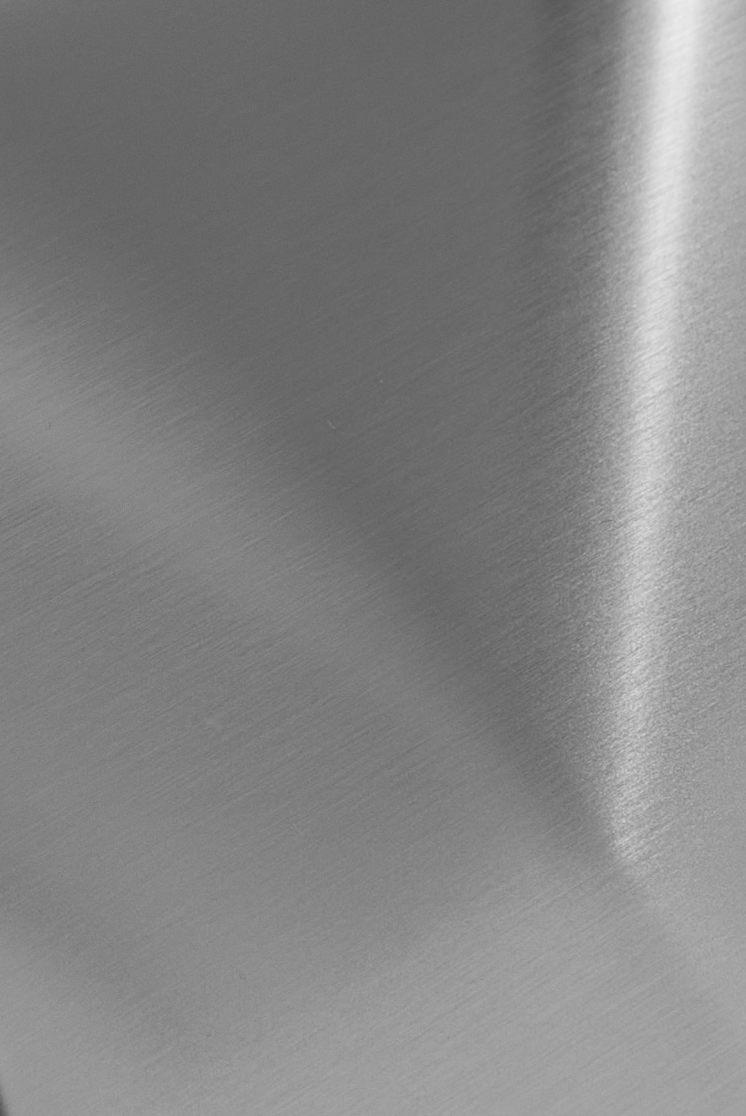

Satin Finish

Foster satin finish **stainless steel** is created using special vegetable fibre brushes which give it a shiny finish with minimal surface roughness. The care given during the process and the special vegetable fibre brushes make it easier to clean the steel.



Vintage Finish

Foster vintage finish **stainless steel** is steel with a special finish obtained by manual brushing that is scratch- and scuff-resistant. The Made in Foster asymmetric brushed finish, obtained using totally artisan methods, recreates the typical signs of ageing, adding a retro touch to the steel.

As well as built-in... how and where you want it

We have increasingly diverse and customised installation methods for worktops. Foster was the first sink manufacturer to engage in new insertion systems and today boasts considerable experience and the most comprehensive range of flush-mount, flat edge and undermount models available on the market.



STD

Standard

Traditional top-mount with the edge that protrudes from the worktop by 8 mm.

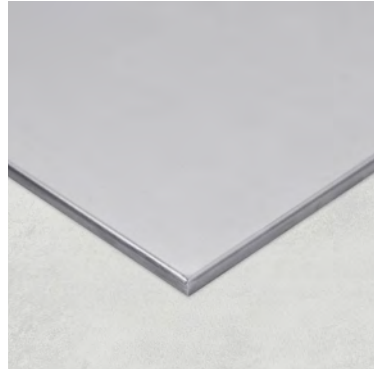

Q4

Q4

Top-mount installation with squared profile and minimal overhang from the worktop (4 mm). Perfect solution for combining it with ceramic glass (induction) hobs.



SF

Flat edge

Sloping edge which protrudes just 3 mm from the worktop, a perfect combination of elegance and ease of installation.

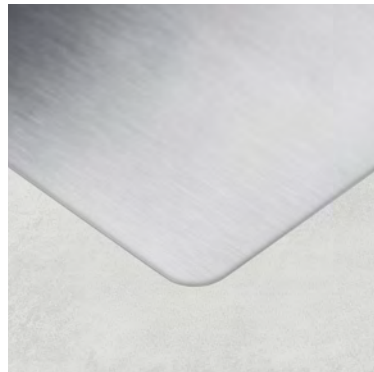
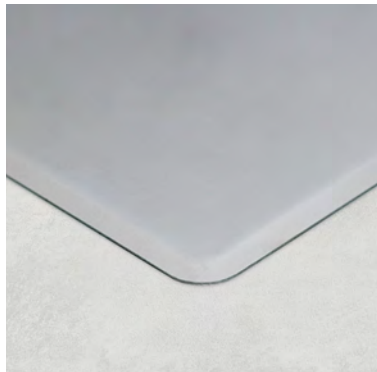

FT

SPT

Flush-mount

Fits into a 1 mm cut-out and is perfectly flush with the worktop. Alternatively, it can be installed on top of it.



ST

Undermount

An elegant and modern solution for installation under the worktop.

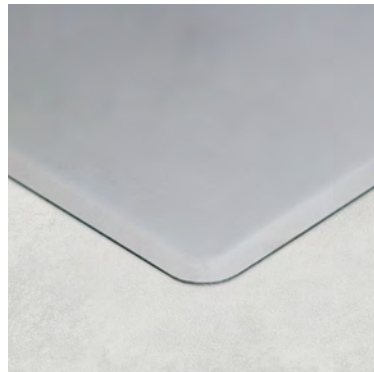

BR

Lowered edge

Sloping edge which protrudes 4 mm from the worktop; easy to install, edge and squared geometries are a single body.



PB

Phantom Base

This is the innovative stainless steel bowl bottom that blends perfectly with sinks made out of slabs.

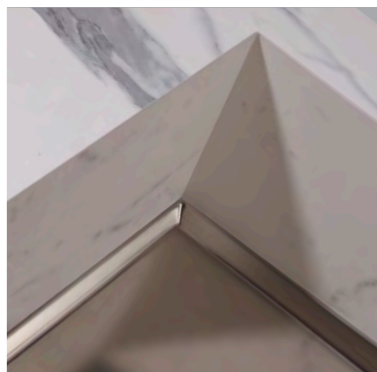

How to read the price list

2
Cabinet 80



Equipment: **2 Black grids Milanello** (8100 602)
Optional accessories on page 286 **4**

3 1040 051 rh
1040 052 lh

1 FT
SPT

FT cut-out: see website
SPT cut-out: 789 x 503

- Satin finish AISI 304 stainless steel
- Dimensions: **806 x 520** - 1 bowl: **430 x 374**
- Space Push automatic waste fitting (PP) 3 1/2"
- Additional holes available
- Triple cut-out system

1 Types of installation

Many Foster sinks are available in several built-in versions that can have slightly different sizes. We therefore recommend that you refer to the specifications next to each version. The dimensions for the type of cut-out are always indicated under the drawing.

3 Right-hand, left-hand and reversible sinks

The double code of the individual models indicates the availability of versions with bowl on the right or on the left. The right version (rh) is with bowl(s) on the right (or larger bowl in models without drainer). Left versions are marked with lh. The unique code indicates that the sink can be reversed, or is only available as shown in the photo and drawing.

4 Accessories indicated for each series

With a focus on combining aesthetics and functionality, Foster has always paid particular attention to the accessories for its products. This price list also heavily features the optional equipment, which is given at the end of each series and refers to the individual models, so that the correct combinations can be easily identified.

accessories



P4

Twin Chopping Board
31.7x42.5 cm
8644 003

4350 001 L1 L3 L4 N2 N3 O2 P1 P2
S T T2 Z Z2

2 Cabinets

A cabinet size is the smallest standard modular kitchen module into which the sink can be fitted. In some cases two sizes are indicated:

(β) for installation in worktops at least 40 mm thick, consider the smaller size, indicated in brackets. (e.g. page 128);

(T) for installation at the beginning/end of the composition, consider the larger size, indicated in brackets.

Please check with kitchen manufacturers for special installations that require work on kitchen units.

Note: the measurements of the cabinets indicated refer to the overall dimensions of the bowls and not to the fixing systems, which may change in different installations.

Please check with kitchen manufacturers for special installations that require work on kitchen units.

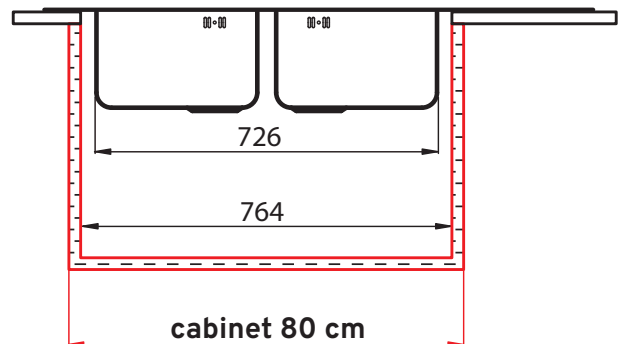

Mixer tap holes

In the drawings at the end of each series, the standard tap holes are indicated with a continuous line. The dotted line indicates the positions of any other holes on request so that the automatic waste fitting control or an eventual dispenser can be fitted immediately. For some models, customisation with additional holes is carried out at an extra charge.

Foster and steel PVD

Physical Vapor Deposition



Steel turns a different colour.

PVD (Physical Vapor Deposition) treatment of steel is an advanced physical process that allows the surface of stainless steel to be altered to achieve unique colouring and superior surface strength.

In the PVD process, stainless steel is placed in a vacuum chamber where selected metals are heated until they turn into vapor. These metal vapors are then deposited on the stainless steel surface by a strong electrical discharge. The metal vapors are then enriched with special process gases, which allow the metal ions to physically stick to the surface of the stainless steel.

The result is a coloured surface, which includes shades such as Gun Metal, Gold and Copper. This process gives the stainless steel treated with PVD an exceptional surface hardness, resistance to UV rays, hypoallergenic characteristics and greater resistance to wear and corrosion, making Foster appliances an ideal choice for sophisticated and functional kitchens.

PVD according to **Foster**



Foster and steel

PVD

Physical Vapor Deposition

The Foster Gun Metal, Gold, Copper, Gun Metal Vintage, Copper Vintage and Gold Vintage PVD range is now enriched with the new Sunset and Brandy colours, giving your kitchen a unique signature touch.

The Gun Metal and Brandy colours are also available in the matt-effect Fumé finish, which makes the surface of the steel silky to the touch and gives greater depth to the Foster PVD colours.



Gun Metal



Gun Metal Vintage



Gun Metal Fumé



Copper



Copper Vintage

- Increased surface hardness, greater resistance to scratches and wear.
- Greater resistance to corrosion.
- Inalterability to UV rays.
- Greater resistance to high temperatures.
- Hypoallergenic characteristics and 100% compatible with food use.

A vertical rectangular swatch of a bright, metallic gold color with a fine, uniform texture.

Gold

A vertical rectangular swatch of a darker, more textured gold color, appearing slightly more aged or 'vintage' with a more pronounced grain.

Gold Vintage

A vertical rectangular swatch of a medium brown color, resembling the hue of brandy, with a fine, consistent texture.

Brandy































A vertical rectangular swatch of a dark, rich brown color, similar to 'brandy fumé', with a slightly more textured appearance than the other swatches.

Brandy Fumé

A vertical rectangular swatch of a vibrant, deep blue color, with a fine, uniform texture.

Sunset

Sinks and bowls

	Gun Metal	Gun Metal fumé	Copper	Gold	Brandy	Brandy fumé	Sunset
Phantom Base	5557 246 sp.20 5557 346 sp.12 		5557 248 sp.20 5557 348 sp.12 	5557 249 sp.20 5557 349 sp.12 			
	5555 246 sp.20 5555 346 sp.12 		5555 248 sp.20 5555 348 sp.12 	5555 249 sp.20 5555 349 sp.12 			
	5554 246 sp.20 5554 346 sp.12 		5554 248 sp.20 5554 348 sp.12 	5554 249 sp.20 5554 349 sp.12 			
Phantom	4371 006 FT SPT 4371 056 ST 		4371 008 FT SPT 4371 058 ST 	4371 009 FT SPT 4371 059 ST 			
	4350 006 FT SPT 4350 056 ST 		4350 008 FT SPT 4350 058 ST 	4350 009 FT SPT 4350 059 ST 			
	4340 006 FT SPT 4340 056 ST 		4340 008 FT SPT 4340 058 ST 	4340 009 FT SPT 4340 059 ST 			
Milanello	1034 056 FT SPT 		1034 058 FT SPT 	1034 059 FT SPT 			
	1034 856 ST 		1034 858 ST 	1034 859 ST 			
Quadra EVO	1257 056 FT SPT 1257 856 ST 						
	1255 056 FT SPT 1255 856 ST 						
	1254 056 FT SPT 1254 856 ST 						
Circolari	1130 066 FT SPT 1130 866 ST 		1130 068 FT SPT 1130 868 ST 	1130 069 FT SPT 1130 869 ST 			

Sinks and bowls

Gun Metal

Gun Metal fumé

Copper

Gold

Brandy

Brandy fumé

Sunset

Quadra R12

1717 056 FT SPT
1717 856 ST



1717 016 FT SPT
1717 816 ST



1717 055 FT SPT
1717 855 ST



1717 015 FT SPT
1717 815 ST



1715 056 FT SPT
1715 856 ST



1715 016 FT SPT
1715 816 ST



1715 055 FT SPT
1715 855 ST



1715 015 FT SPT
1715 815 ST



KE R15

2157 056 FT SPT
2157 856 ST



2157 058 FT SPT
2157 858 ST



2157 059 FT SPT
2157 859 ST



2157 055 FT SPT
2157 855 ST



Vintage

2157 086 FT SPT
2157 886 ST



2157 888 ST



2157 889 ST



2155 056 FT SPT
2155 856 ST



2155 058 FT SPT
2155 858 ST



2155 059 FT SPT
2155 859 ST



2155 055 FT SPT
2155 855 ST



Vintage

2155 086 FT SPT
2155 886 ST



2155 888 ST



2155 889 ST



2154 056 FT SPT
2154 856 ST



2156 056 FT SPT
2156 856 ST



2156 858 ST



2156 859 ST



Vintage

2156 086 FT SPT
2156 886 ST



2156 888 ST



2156 889 ST



2153 856 ST



2151 856 ST

















Single bowl
S1000



















1180 156 STD





Mixer taps

	Gun Metal	Gun Metal fumé	Copper	Gold	Brandy	Brandy fumé	Sunset
Skin	 8424 856		 8424 858	 8424 859			 8424 851
Iota	 8426 106						
Omega Plus	 8498 856		 8498 858	 8498 859			 8498 851
Omega	 8497 856		 8497 400	 8497 700			
Margot	 8524 006		 8524 008	 8524 009		Dispenser EVO Gun Metal 8520 856	

Gas hobs

	Gun Metal	Gun Metal fumé	Copper	Gold	Brandy	Brandy fumé	Sunset
Milanello	 7682 006 FT SPT		 7682 008 FT SPT	 7682 009 FT SPT			
	 7681 006 FT SPT		 7681 008 FT SPT	 7681 009 FT SPT			
	 7680 006 FT SPT		 7680 008 FT SPT	 7680 009 FT SPT			
Milano	 7639 006 FT SPT		 7639 008 FT SPT	 7639 009 FT SPT			
	 7638 006 FT SPT		 7638 008 FT SPT	 7638 009 FT SPT			
	 7640 006 FT SPT		 7640 008 FT SPT	 7640 009 FT SPT			

Gas hobs

	Gun Metal	Gun Metal fumé	Copper	Gold	Brandy	Brandy fumé	Sunset
KE	7601 632 FT SPT 		7601 886 FT SPT 	7601 932 FT SPT 			

Ovens

	Gun Metal	Gun Metal fumé	Copper	Gold	Brandy	Brandy fumé	Sunset
FL 90	7107 646 						

Accessories

	Gun Metal	Gun Metal fumé	Copper	Gold	Brandy	Brandy fumé	Sunset
Colander	8151 006 		8151 008 	8151 009 			
Socket holders	8000 116 		8000 118 	8000 119 			
Waste fittings	8407 110 						
	8407 120 		8407 122 	8407 121 			8403 325 

PVD according to **Foster**







PVD, Physical Vapor Deposition, is not a simple finish, it is a real treatment that penetrates inside the stainless steel, making the colour inalterable by wear and time.

Thanks to the PVD treatment, the steel of Foster products is perfect for people who love a kitchen to live and inhabit each day.

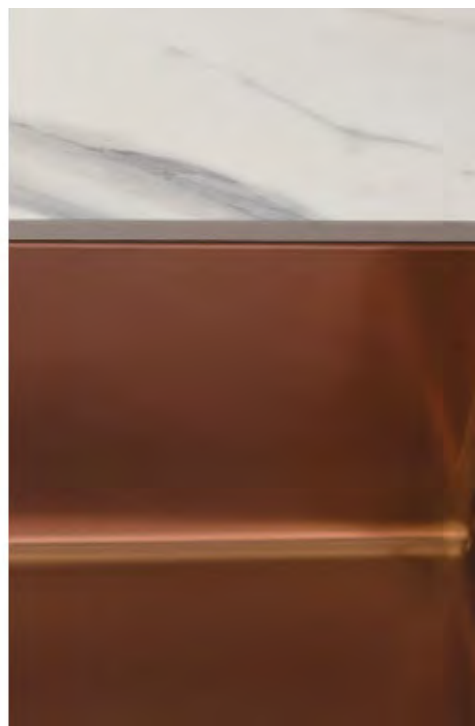
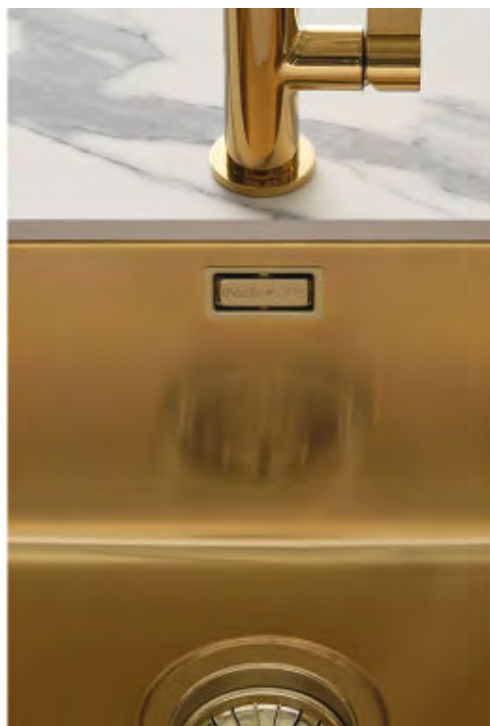
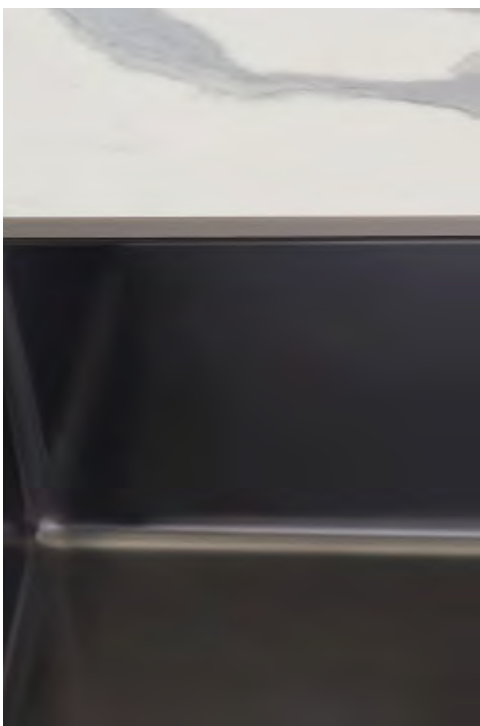
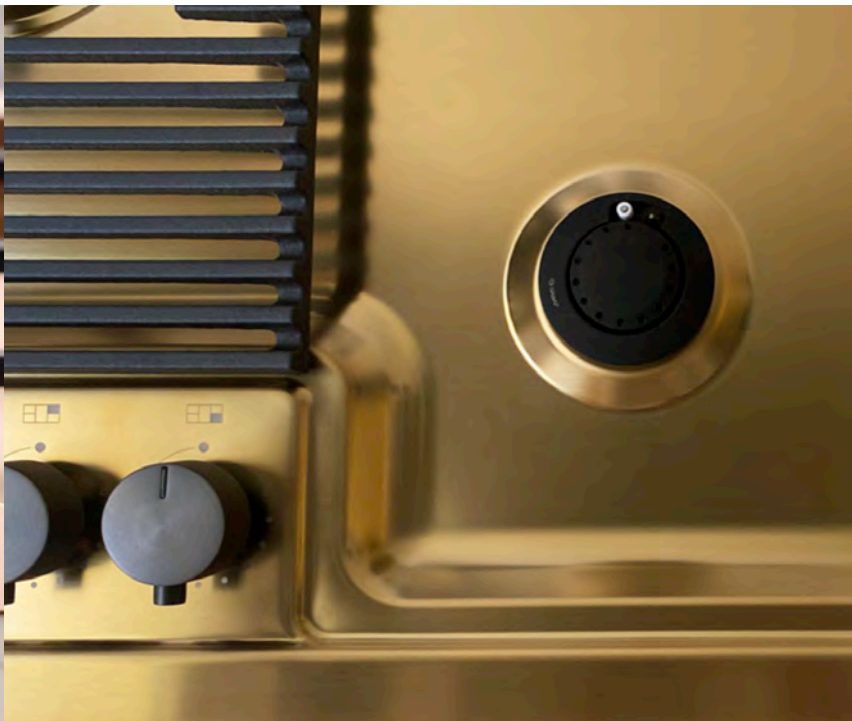





20	Gun Metal
44	Copper
62	Gold
80	Brandy 
86	Sunset 

Foster PVD





PVD | Gun Metal





Cabinet 80



5557 246



For 20 mm thick slabs
Dimensions: **756 x 446**
1 bowl: **716 x 406**

5557 346



For 12 mm thick slabs
Dimensions: **740 x 430**
1 bowl: **716 x 406**

- Cut-out: see website
- Bottom in Gun Metal AISI 304 stainless steel
- 3/2" waste fitting + universal corrugated pipe for installing different overflows

Accessories, technical drawing and automatic waste fittings on page 214

Cabinet 60



5555 246



For 20 mm thick slabs
Dimensions: **546 x 446**
1 bowl: **506 x 406**

5555 346



For 12 mm thick slabs
Dimensions: **530 x 430**
1 bowl: **506 x 406**

- Cut-out: see website
- Bottom in Gun Metal AISI 304 stainless steel
- 3/2" waste fitting + universal corrugated pipe for installing different overflows

Accessories, technical drawing and automatic waste fittings on page 214

Cabinet 60



5554 246



For 20 mm thick slabs
Dimensions: **446 x 446**
1 bowl: **406 x 406**

5554 346



For 12 mm thick slabs
Dimensions: **430 x 430**
1 bowl: **406 x 406**

- Cut-out: see website
- Bottom in Gun Metal AISI 304 stainless steel
- 3/2" waste fitting + universal corrugated pipe for installing different overflows

Accessories, technical drawing and automatic waste fittings on page 214

Cabinet 80

4371 006
 FT

FT cut-out: see website*

 SPT

SPT cut-out: 718 x 408 R16*

- Gun Metal AISI 304 steel
- Dimensions: **726 x 416** - 1 bowl: **710 x 400**
- 3½" waste fitting
- *The built-in cut-out requires a recess to house the overflow (see website)

Accessories, technical drawing and automatic waste fittings on page 100

Cabinet 80

4371 056
 ST

cut-out: see website

- Gun Metal AISI 304 steel
- Dimensions: **726 x 416** - 1 bowl: **710 x 400**
- 3½" waste fitting

Accessories, technical drawing and automatic waste fittings on page 220

Cabinet 60

4350 006
 FT

FT cut-out: see website*

 SPT

SPT cut-out: 508 x 408 R16*

- Gun Metal AISI 304 steel
- Dimensions: **516 x 416** - 1 bowl: **500 x 400**
- 3½" waste fitting
- *The built-in cut-out requires a recess to house the overflow (see website)

Accessories, technical drawing and automatic waste fittings on page 100

Cabinet 60



4350 056

ST

cut-out: see website

- Gun Metal AISI 304 steel
- Dimensions: **516 x 416** - 1 bowl: **500 x 400**
- 3½" waste fitting

Accessories, technical drawing and automatic waste fittings on page 220

Cabinet 45



4340 006

FT

FT cut-out: see website*

SPT

SPT cut-out: 408 x 408 R16*

- Gun Metal AISI 304 steel
- Dimensions: **416 x 416** - 1 bowl: **400 x 400**
- 3½" waste fitting
- *The built-in cut-out requires a recess to house the overflow (see website)

Accessories, technical drawing and automatic waste fittings on page 100

Cabinet 45



4340 056

ST



cut-out: see website

- Gun Metal AISI 304 steel
- Dimensions: **416 x 416** - 1 bowl: **400 x 400**
- 3½" waste fitting

Accessories, technical drawing and automatic waste fittings on page 220

Cabinet 80



1034 056	 FT	FT cut-out: see website
	 SPT	SPT cut-out: 789 x 503

- Gun Metal AISI 304 steel
- Dimensions: **806 x 520** - 1 bowl: **750 x 374**
- Space Push 3 1/2" automatic waste fitting (PO)
- Additional holes available
- Three-steps system

Included: **2 Black grids Milanello** (8100 602)
Optional accessories and technical drawing on page 106

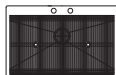

Configuration of Black grids flush with bowl

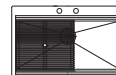

Configuration of Black grids at bottom of bowl

Cabinet 90



1034 856	 ST	cut-out: 750 x 426
-----------------	--	--------------------

- Gun Metal AISI 304 steel
- Dimensions: **790 x 466** - 1 bowl: **750 x 426**
- SPACE 3 1/2" waste fitting
- Three-steps system

Included: **2 Black grids Milanello** (8100 602)
Accessories, technical drawing and automatic waste fittings on page 226



Configuration of Black grids flush with bowl



Configuration of Black grids at bottom of bowl

Cabinet 80

1257 056

 FT

FT cut-out: see website*

 SPT

SPT cut-out: 760 x 450*



- Gun Metal AISI 304 steel
- Dimensions: **780 x 470** - 1 bowl: **740 x 430**
- 3½" waste fitting
- * The hole requires a cut-out to house the overflow (see website)

Included: **2 grids** (8100 614 - 8100 615)
Accessories, technical drawing and automatic waste fittings on page 118



Configuration of Black grids flush with bowl

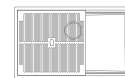

Configuration of Black grids at bottom of bowl

Cabinet 90

1257 856

 ST

cut-out: 740 x 452 R5



- Gun Metal AISI 304 steel
- Dimensions: **780 x 470** - 1 bowl: **740 x 430**
- 3.5" waste fitting

Included: **2 grids** (8100 614 - 8100 615)
Accessories, technical drawing and automatic waste fittings on page 238



Configuration of Black grids flush with bowl

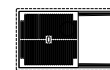

Configuration of Black grids at bottom of bowl

Cabinet 60

1255 056

 FT

FT cut-out: see website*

 SPT

SPT cut-out: 550 x 450*



- Gun Metal AISI 304 steel
- Dimensions: **570 x 470** - 1 bowl: **530 x 430**
- 3½" waste fitting
- * The hole requires a cut-out to house the overflow (see website)

Included: **1 grid** (8100 615)
Accessories, technical drawing and automatic waste fittings on page 118



Configuration of Black grids flush with bowl



Configuration of Black grids at bottom of bowl

Code

Version

Characteristics

Price

Cabinet 80**1255 856****ST**

cut-out: 530 x 452 R5



- Gun Metal AISI 304 steel
- Dimensions: **570 x 470** - 1 bowl: **530 x 430**
- 3.5" waste fitting

Included: **1 grid** (8100 615)
Accessories, technical drawing and automatic
waste fittings on page 238



Configuration of
Black grids
flush with bowl



Configuration of
Black grids
at bottom of bowl

Cabinet 60**1254 056****FT**

FT cut-out: see website*

SPT

SPT cut-out: 450 x 450*



- Gun Metal AISI 304 steel
- Dimensions: **470 x 470** - 1 bowl: **430 x 430**
- 3½" waste fitting
- * The hole requires a cut-out to house the overflow
(see website)

Included: **1 grid** (8100 615)
Accessories, technical drawing and automatic
waste fittings on page 118



Configuration of
Black grids
flush with bowl

Cabinet 60**1254 856****ST**

cut-out: 430 x 452 R5



- Gun Metal AISI 304 steel
- Dimensions: **470 x 470** - 1 bowl: **430 x 430**
- 3.5" waste fitting

Included: **1 grid** (8100 615)
Accessories, technical drawing and automatic
waste fittings on page 238



Configuration of
Black grids
flush with bowl

Gun Metal Quadra R12 NEW

Code

Version

Characteristics

Price

Cabinet 80



1717 056

 FT

FT cut-out: see website*

 SPT

SPT cut-out: 730 x 430*

- Gun Metal AISI 304 steel
- Dimensions: **750 x 440** - 1 bowl: **710 x 400**
- 3½” waste fitting
- *The hole requires a cut-out to house the overflow (only for worktops >30)

• Also available in version

Gun Metal Fumè
1717 016



Included: **1 grid** (8100 617)
Accessories, technical drawing and automatic waste fittings on page 124

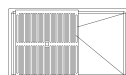

Configuration of Black grids flush with bowl



Configuration of Black grids at bottom of bowl

Cabinet 80



1717 856

 ST

cut-out: 710 x 400 R12

- Gun Metal AISI 304 steel
- Dimensions: **750 x 440** - 1 bowl: **710 x 400**
- 3.5” waste fitting

• Also available in version

Gun Metal Fumè
1717 816



Included: **1 grid** (8100 617)
Accessories, technical drawing and automatic waste fittings on page 244

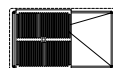

Configuration of Black grids flush with bowl



Configuration of Black grids at bottom of bowl

Cabinet 60



1715 056

 FT

FT cut-out: see website*

 SPT

SPT cut-out: 520 x 430*

- Gun Metal AISI 304 steel
- Dimensions: **540 x 440** - 1 bowl: **500 x 400**
- 3½” waste fitting
- *The hole requires a cut-out to house the overflow (only for worktops >30)

• Also available in version

Gun Metal Fumè
1715 016



Included: **1 grid** (8100 617)
Accessories, technical drawing and automatic waste fittings on page 124



Configuration of Black grids flush with bowl



Configuration of Black grids at bottom of bowl

Cabinet 60



Included: **1 grid** (8100 617)
Accessories, technical drawing and automatic
waste fittings on page 244

Code	Version	Characteristics	Price
------	---------	-----------------	-------

1715 856	ST	cut-out: 500 x 400 R12	
-----------------	-----------	------------------------	--

- Gun Metal AISI 304 steel
- Dimensions: **540 x 440** - 1 bowl: **500 x 400**
- 3.5" waste fitting

• Also available in version

Gun Metal Fumè
1715 816



Configuration of
Black grids
flush with bowl



Configuration of
Black grids
at bottom of bowl

Gun Metal Circolari **NEW**

Cabinet 45



Accessories, technical drawing and automatic
waste fittings on page 132

Code	Version	Characteristics	Price
------	---------	-----------------	-------

1130 066	FT	FT cut-out: see website*	
	SPT	SPT cut-out: Ø 410*	

- Gun Metal AISI 304 steel
- Dimensions: **Ø 425** - 1 bowl: **Ø 380**
- 3½" waste fitting
- *The built-in hole requires a cut-out to house the overflow

Cabinet 60



Accessories, technical drawing and automatic
waste fittings on page 252

1130 866	ST	cut-out: Ø 380	
-----------------	-----------	----------------	--

- Gun Metal AISI 304 steel
- Dimensions: **Ø 425** - 1 bowl: **Ø 380**
- 3½" waste fitting

Gun Metal Bowls KE R15

Code

Version

Characteristics

Price

Cabinet 80



2157 056

FT

FT cut-out: see website*

SPT

SPT cut-out: 730 x 420*

- Gun Metal AISI 304 steel
- Dimensions: **750 x 440** - 1 bowl: **710 x 400**
- 3/2" waste fitting

* The built-in cut-out requires a recess to house the overflow (see website)

• Also available in version

Vintage
2157 086



Accessories, technical drawing and automatic waste fittings on page 162

Cabinet 80



2157 856

ST

cut-out: 710 x 400 R15

- Gun Metal AISI 304 steel
- Dimensions: **750 x 440** - 1 bowl: **710 x 400**
- 3/2" waste fitting

• Also available in version

Vintage
2157 886



Accessories, technical drawing and automatic waste fittings on page 162

Cabinet 60



2155 056

FT

FT cut-out: see website*

SPT

SPT cut-out: 520 x 420*

- Gun Metal AISI 304 steel
- Dimensions: **540 x 440** - 1 bowl: **500 x 400**
- 3/2" waste fitting

* The built-in cut-out requires a recess to house the overflow (see website)

• Also available in version

Vintage
2155 086



Accessories, technical drawing and automatic waste fittings on page 252

Code

Version

Characteristics

Price

Cabinet 60

2155 856

ST

cut-out: 500 x 400 R15



- Gun Metal AISI 304 steel
- Dimensions: **540 x 440** - 1 bowl: **500 x 400**
- 3½" waste fitting

• Also available in version

Vintage
2155 886



Accessories, technical drawing and automatic waste fittings on page 270

Cabinet 60

2154 056

FT

FT cut-out: see website*

SPT

SPT cut-out: 470 x 420*



- Gun Metal AISI 304 steel
- Dimensions: **490 x 440** - 1 bowl: **450 x 400**
- 3½" waste fitting

* The built-in cut-out requires a recess to house the overflow (see website)

Accessories, technical drawing and automatic waste fittings on page 162

Cabinet 60

2154 856

ST

cut-out: 450 x 400 R15



- Gun Metal AISI 304 steel
- Dimensions: **490 x 440** - 1 bowl: **450 x 400**
- 3½" waste fitting

Accessories, technical drawing and automatic waste fittings on page 270

Gun Metal Bowls KE R15

Code

Version

Characteristics

Price

Cabinet 45



2156 056

FT

FT cut-out: see website*

SPT

SPT cut-out: 420 x 420*

- Gun Metal AISI 304 steel
- Dimensions: **440 x 440** - 1 bowl: **400 x 400**
- 3½" waste fitting

* The built-in cut-out requires a recess to house the overflow (see website)

• Also available in version

Vintage
2156 086



Accessories, technical drawing and automatic waste fittings on page 162

Cabinet 60



2156 856

ST

cut-out: 400 x 400 R15

- Gun Metal AISI 304 steel
- Dimensions: **440 x 440** - 1 bowl: **400 x 400**
- 3½" waste fitting

• Also available in version

Vintage
2156 886



Accessories, technical drawing and automatic waste fittings on page 270

Cabinet 45



2153 856

ST

cut-out: 340 x 400 R15

- Gun Metal AISI 304 steel
- Dimensions: **380 x 440** - 1 bowl: **340 x 400**
- 3½" waste fitting

Accessories, technical drawing and automatic waste fittings on page 270

Code	Version	Characteristics	Price
------	---------	-----------------	-------

Cabinet 30

2151 856  **ST** cut-out: 180 x 400 R15



- Gun Metal AISI 304 steel
- Dimensions: **222 x 442** - 1 bowl: **180 x 400**
- 3/2" waste fitting

Accessories, technical drawing and automatic waste fittings on page 270

Gun Metal Single bowl S1000 NEW

Cabinet 80

1180 156  **BR** cut-out: 840 x 480



- Gun Metal AISI 304 steel
- Dimensions: **865 x 505** - 1 bowl: **726 x 350**
- 3/2" waste fitting
- Additional holes available

Accessories, technical drawing and automatic waste fittings on page 202

Gun Metal Accessories and automatic waste fittings

Z5
Stainless steel perforated tray
21.5x38 cm
8151 006

NEW



To be used in combination with

- N3** 8644 101
- K2** 8100 037
- K1** 8100 627



Gun Metal **automatic waste fitting** with rotating round remote control and perimeter overflow



Space Push Gun Metal **automatic waste fitting** with round push remote control and perimeter overflow. Double plug included: Space and "basket".





Characteristics

Code

Price

- Single-lever mixer tap
- Swivel tap body and flexible shower head
- Strengthening plate: \varnothing 50 mm

8424 856

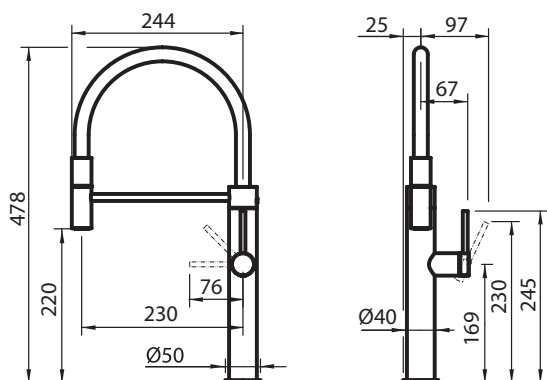

Characteristics





Characteristics

- Single-lever mixer tap
- Swivel tap body and flexible shower head
- Strengthening plate: \varnothing 50 mm

Code

8426 106
Satin finish

Price

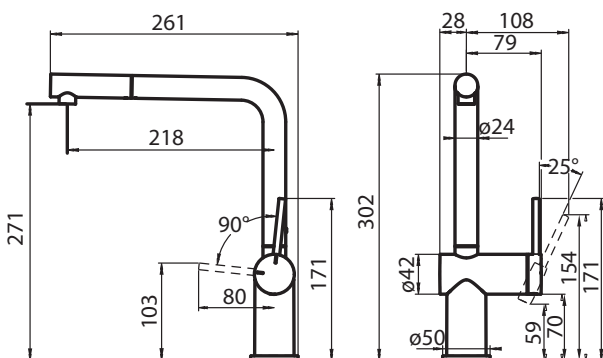

Functions



Gun Metal Omega Plus



Characteristics

- Single-lever mixer tap
- Swivel tap body and extractable shower-head
- Strengthening plate: \varnothing 50 mm

Code

8498 856

Price

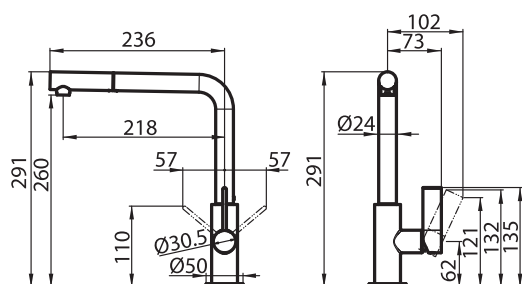

Functions





Characteristics

Code

Price

- Single-lever mixer tap
- Swivel tap body
- Strengthening plate: \varnothing 50 mm

8497 856

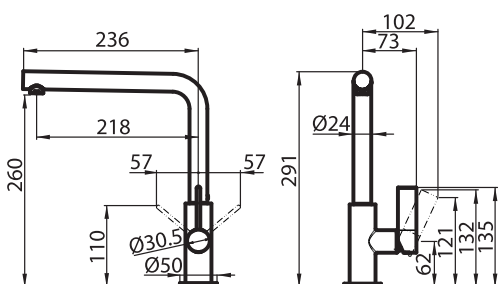

Functions





Characteristics

Code

Price

- Single-lever mixer tap
- Up&down collapsible swivel tap body
- Strengthening plate: \varnothing 55 mm

8524 006

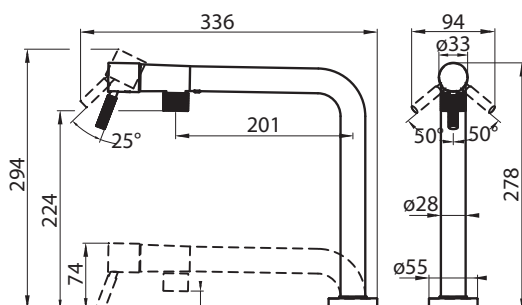

Functions



Gun Metal Dispenser Evo

Characteristics

Code

Price

PVD



Built-in dispenser for liquid detergent/soap

8520 856

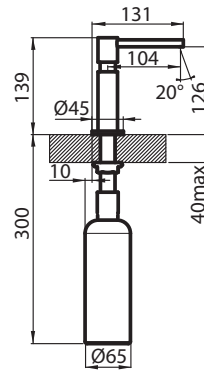

Gun Metal Milanello

Code

Version

Characteristics

Price

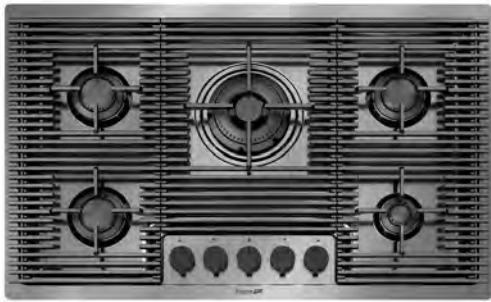

Accessories: **2** (see page 401)

Technical drawing on page 430

7682 006

FT

FT cut-out: see website

SPT

SPT cut-out: 790x500

- Gun Metal AISI 304
- Dimensions: **803 x 513**
- Cast iron grids and enamelled burner covers
- Electric ignition
- Safety valve with ultra-rapid thermocouple
- Total power 10,250 W
auxiliary: 1,000 W
semirapid: 3x1,750 W
double crown: 4,000 W

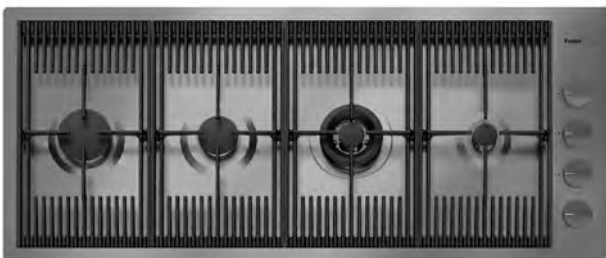

Accessories: **2** (see page 401)

Technical drawing on page 430

7681 006

FT

FT cut-out: see website

SPT

SPT cut-out: 1098x459

- Gun Metal AISI 304
- Dimensions: **1115 x 476**
- Cast iron grids and enamelled burner covers
- Electric ignition
- Safety valve with ultra-rapid thermocouple
- Total power 10,750 W
auxiliary: 1,000 W
semirapid: 1,750 W
rapid: 3,000 W
dual: 5,000 W

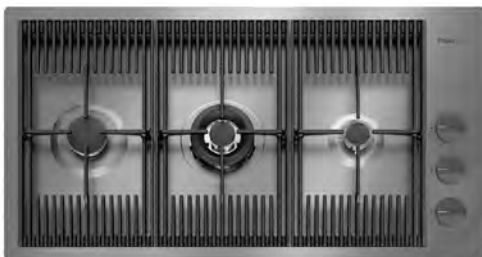

Accessories: **2** (see page 401)

Technical drawing on page 430

7680 006

FT

FT cut-out: see website



SPT

SPT cut-out: 853x459

- Gun Metal AISI 304
- Dimensions: **870 x 476**
- Cast iron grids and enamelled burner covers
- Electric ignition
- Safety valve with ultra-rapid thermocouple
- Total power 7,750 W
auxiliary: 1,000 W
semirapid: 1,750 W
dual: 5,000 W

Code	Version	Characteristics	Price
------	---------	-----------------	-------



7639 006	 FT	FT cut-out: see website
	 SPT	SPT cut-out: 1134x540

- Gun Metal AISI 304
- Dimensions: **1154x560**
- Cast iron grids and enamelled burner covers
- Electric ignition
- Safety valve with ultra-rapid thermocouple



- Total power 15,900 W
auxiliary: 1,000 W
semirapid: 2x1,750 W
rapid: 3,000 W
dual: 2x4,200 W



Included: 2x 2 (see page 401)

Technical drawing on page 430



7638 006	 FT	FT cut-out: see website
	 SPT	SPT cut-out: 1036x540

- Gun Metal AISI 304
- Dimensions: **1056x560**
- Cast iron grids and enamelled burner covers
- Electric ignition
- Safety valve with ultra-rapid thermocouple



- Total power 10,950 W
auxiliary: 2x1,000 W
semirapid: 1,750 W
rapid: 3,000 W
dual: 4,200 W



Included: 2 (see page 401)

Technical drawing on page 430



7640 006	 FT	FT cut-out: see website
	 SPT	SPT cut-out: 1060x470

- Gun Metal AISI 304
- Dimensions: **1080x490**
- Cast iron grids and enamelled burner covers
- Electric ignition
- Safety valve with ultra-rapid thermocouple

- Total power 9,950 W
auxiliary: 1,000 W
semirapid: 1,750 W
rapid: 3,000 W
dual: 4,200 W



Included: 2 (see page 401)

Technical drawing on page 430

Gun Metal KE

Code

Version

Characteristics

Price

7601 632

FT

FT cut-out: see website

SPT

SPT cut-out: 790x500



Accessories: **2** (see page 401)
 Technical drawing on page 430

- Gun Metal AISI 304
- Dimensions: **803x513**
- Cast iron grids and enamelled burner covers
- Electric ignition
- Safety valve with ultra-rapid thermocouple
- Total power 9,500 W
 auxiliary: 2x1,100 W
 semirapid: 2x1,750 W
 triple crown: 3,800

Gun Metal Socket holders

Code

Price



8000 116

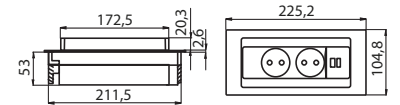

Push socket holder slot in Gun Metal PVD stainless steel for built-in installation on worktops.
 2 Schuko sockets - 1 USB socket for charging.
 Built-in hole: **215 x 88**



Gun Metal Ovens FL 90 NEW

Multifunction 90 x 48 | 91 litres
Energy class A



Code	Finish	Price
7107 646	Gun Metal	

- 10 cooking functions
- Display with electronic start-end cooking program and push-pull controls
- Maxi-Grill (collapsible)
- Grill resistance protection
- Halogen lighting on both walls, switches on when the door is opened
- Door contact switch
- Supply: 220-240V 50-60Hz
- Removable glass
- Easy clean enamel
- 2 telescopic guides
- Full glass door
- Triple glass door
- Cooking chamber capacity XXL
- Tangential ventilation

Standard equipment:

- deep tray
- stainless steel grid

Functions

Technical drawing on page 454

PVD | Copper





Cabinet 80



5557 248



installation in worktops: 20 mm
Dimensions: **756 x 446**
1 bowl: **716 x 406**

5557 348



installation in worktops: 12 mm
Dimensions: **740 x 430**
1 bowl: **716 x 406**

- Cut-out: see website
- Bottom in Copper AISI 304 stainless steel
- 3/2" waste fitting + universal corrugated pipe for installing different overflows

Accessories, technical drawing and automatic waste fittings on page 214

Cabinet 60



5555 248



installation in worktops: 20 mm
Dimensions: **546 x 446**
1 bowl: **506 x 406**

5555 348



installation in worktops: 12 mm
Dimensions: **530 x 430**
1 bowl: **506 x 406**

- Cut-out: see website
- Bottom in Copper AISI 304 stainless steel
- 3/2" waste fitting + universal corrugated pipe for installing different overflows

Accessories, technical drawing and automatic waste fittings on page 214

Cabinet 60



5554 248



installation in worktops: 20 mm
Dimensions: **446 x 446**
1 bowl: **406 x 406**

5554 348



installation in worktops: 12 mm
Dimensions: **430 x 430**
1 bowl: **406 x 406**

- Cut-out: see website
- Bottom in Copper AISI 304 stainless steel
- 3/2" waste fitting + universal corrugated pipe for installing different overflows

Accessories, technical drawing and automatic waste fittings on page 214

Cabinet 80**4371 008**
 FT

FT cut-out: see website*

 SPT

SPT cut-out: 718 x 408 R16*

- Copper AISI 304 stainless steel
- Dimensions: **726 x 416** - 1 bowl: **710 x 400**
- 3½" waste fitting
- *The built-in cut-out requires a recess to house the overflow (see website)

Accessories, technical drawing and automatic waste fittings on page 100

Cabinet 80**4371 058**
 ST

cut-out: see website



- Copper AISI 304 stainless steel
- Dimensions: **726 x 416** - 1 bowl: **710 x 400**
- 3½" waste fitting

Accessories, technical drawing and automatic waste fittings on page 220

Cabinet 60**4350 008**
 FT

FT cut-out: see website*

 SPT

SPT cut-out: 508 x 408 R16*



- Copper AISI 304 stainless steel
- Dimensions: **516 x 416** - 1 bowl: **500 x 400**
- 3½" waste fitting
- *The built-in cut-out requires a recess to house the overflow (see website)

Accessories, technical drawing and automatic waste fittings on page 100

Cabinet 60**4350 058** **ST**

cut-out: see website



- Copper AISI 304 stainless steel
- Dimensions: **516 x 416** - 1 bowl: **500 x 400**
- 3½" waste fitting

Accessories, technical drawing and automatic waste fittings on page 220

Cabinet 45**4340 008** **FT**

FT cut-out: see website*

 **SPT**

SPT cut-out: 408 x 408 R16*



- Copper AISI 304 stainless steel
- Dimensions: **416 x 416** - 1 bowl: **400 x 400**
- 3½" waste fitting
- *The built-in cut-out requires a recess to house the overflow (see website)

Accessories, technical drawing and automatic waste fittings on page 100

Cabinet 45**4340 058** **ST**

cut-out: see website



- Copper AISI 304 stainless steel
- Dimensions: **416 x 416** - 1 bowl: **400 x 400**
- 3½" waste fitting

Accessories, technical drawing and automatic waste fittings on page 220

Cabinet 80



Included: **2 Black grids Milanello** (8100 602)
Accessories and technical drawing on page 106

1034 058

 FT

FT cut-out: see website

 SPT

SPT cut-out: 789 x 503

- Copper AISI 304 stainless steel
- Dimensions: **806 x 520** - 1 bowl: **750 x 374**
- Space Push 3 ½" automatic waste fitting (PB)
- Additional holes available
- Three-steps system

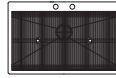

Configuration of
Black grids
flush with bowl

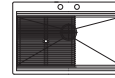

Configuration of
Black grids
at bottom of bowl

Cabinet 90



Included: **2 Black grids Milanello** (8100 602)
Accessories, technical drawing and automatic
waste fittings on page 226

1034 858

 ST

cut-out: 750 x 426

- Copper AISI 304 stainless steel
- Dimensions: **790 x 466** - 1 bowl: **750 x 374**
- SPACE 3 ½" waste fitting
- Three-steps system



Configuration of
Black grids
flush with bowl

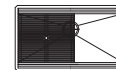

Configuration of
Black grids
at bottom of bowl

Cabinet 80

2157 058

FT

FT cut-out: see website*

SPT

SPT cut-out: 730 x 420*



- Copper AISI 304 stainless steel
- Dimensions: **750 x 440** - 1 bowl: **710 x 400**
- 3/2" waste fitting

* The built-in cut-out requires a recess to house the overflow (see website)

Accessories, technical drawing and automatic waste fittings on page 162

Cabinet 80

2157 858

ST

cut-out: 710 x 400 R15



- Copper AISI 304 stainless steel
- Dimensions: **750 x 440** - 1 bowl: **710 x 400**
- 3/2" waste fitting

• Also available in version

Vintage
2157 888



Accessories, technical drawing and automatic waste fittings on page 270

Cabinet 60

2155 058

FT

FT cut-out: see website*

SPT

SPT cut-out: 520 x 420*



- Copper AISI 304 stainless steel
- Dimensions: **540 x 440** - 1 bowl: **500 x 400**
- 3/2" waste fitting

* The built-in cut-out requires a recess to house the overflow (see website)

Accessories, technical drawing and automatic waste fittings on page 162

Code

Version

Characteristics

Price

Cabinet 60

2155 858

ST

cut-out: 500 x 400 R15



- Copper AISI 304 stainless steel
- Dimensions: **540 x 440** - 1 bowl: **500 x 400**
- 3/2" waste fitting

• Also available in version

Vintage
2155 888



Accessories, technical drawing and automatic waste fittings on page 270

Cabinet 60

2156 858

ST

cut-out: 400 x 400 R15



- Copper AISI 304 stainless steel
- Dimensions: **440 x 440** - 1 bowl: **400 x 400**
- 3/2" waste fitting

• Also available in version

Vintage
2156 888



Accessories, technical drawing and automatic waste fittings on page 270

Cabinet 45



1130 068

FT

FT cut-out: see website*

SPT

SPT cut-out: Ø 410*

- Copper AISI 304 stainless steel
- Dimensions: Ø 425 - 1 bowl: Ø 380
- 3½" waste fitting
- *The built-in hole requires a cut-out to house the overflow

Accessories, technical drawing and automatic waste fittings on page 132

Cabinet 60



1130 868

ST

cut-out: Ø 380

- Copper AISI 304 stainless steel
- Dimensions: Ø 425 - 1 bowl: Ø 380
- 3½" waste fitting

Accessories, technical drawing and automatic waste fittings on page 252

Accessories and automatic waste fittings

Z6

Stainless steel perforated tray
21.5x38 cm
8151 008

NEW



To be used in combination with

N3 8644 101

K2 8100 037

K1 8100 627

PB

8407122



NEW

Space Push Copper **automatic waste fitting** with round push remote control and perimeter overflow. Double plug included: Stainless steel space and "basket".





Characteristics

Code

Price

- Single-lever mixer tap
- Swivel tap body and flexible shower head
- Strengthening plate: \varnothing 50 mm

8424 858

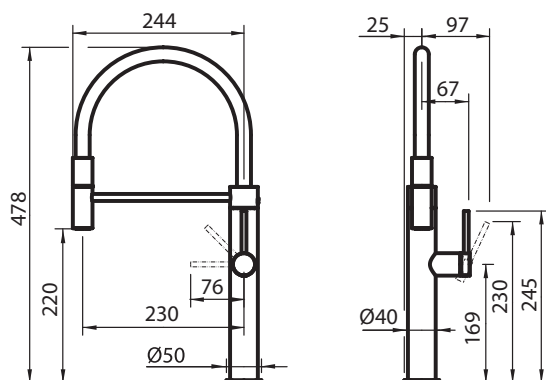

Characteristics



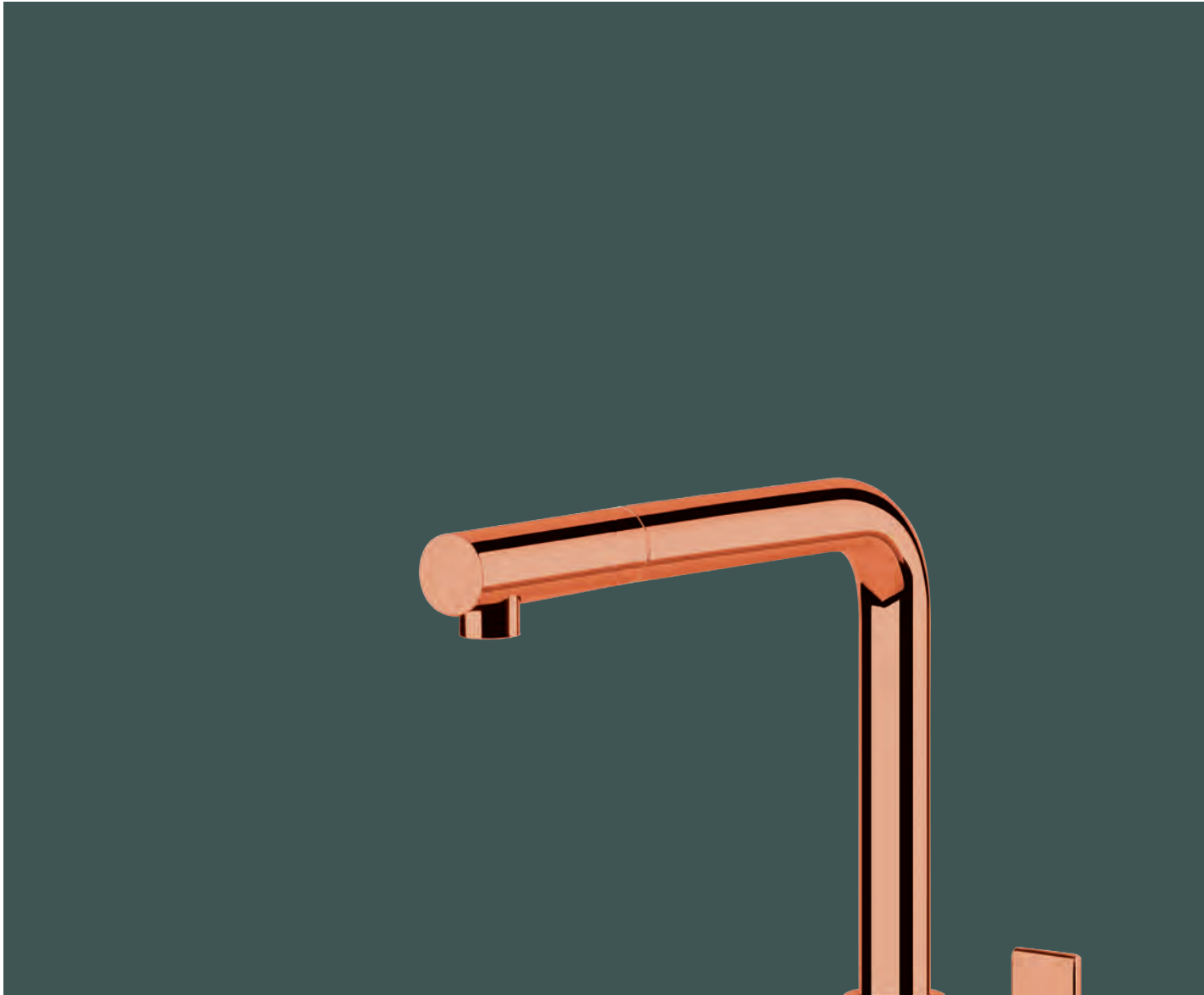

Characteristics

Code

Price

- Single-lever mixer tap
- Swivel tap body and extractable shower-head
- Strengthening plate: \varnothing 50 mm

8498 858

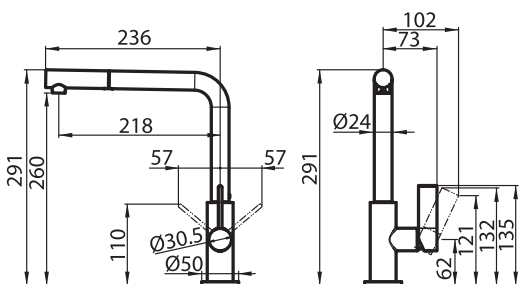
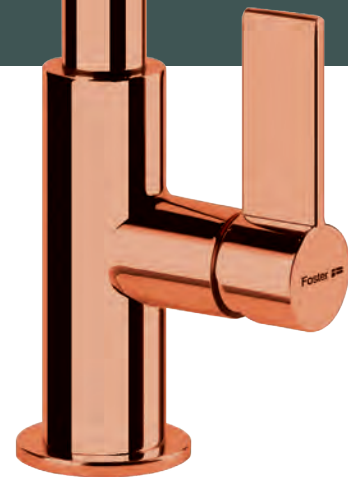

Functions



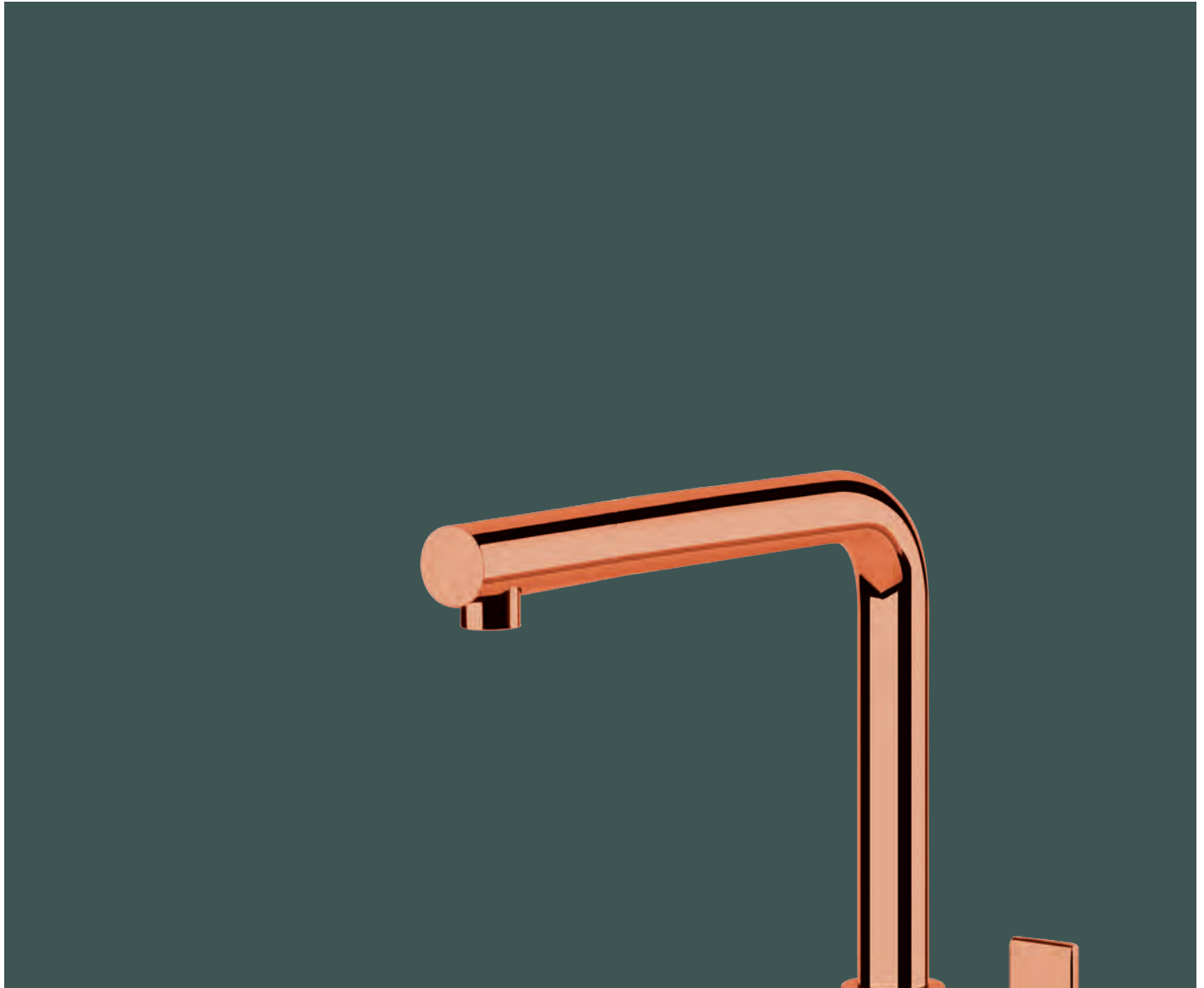

Characteristics

- Single-lever mixer tap
- Swivel tap body
- Strengthening plate: \varnothing 50 mm

Code

8497 400

Price

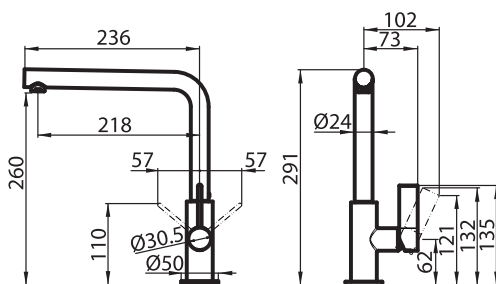
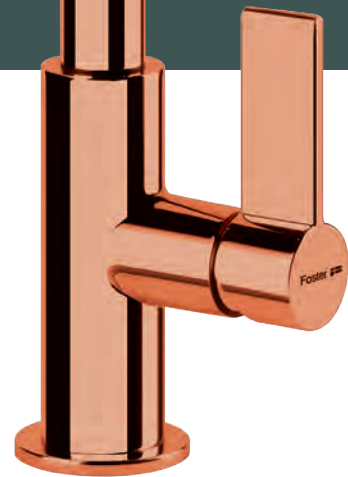

Functions





Characteristics

Code

Price

- Single-lever mixer tap
- Up&down collapsible swivel tap body
- Strengthening plate: \varnothing 55 mm

8524 008

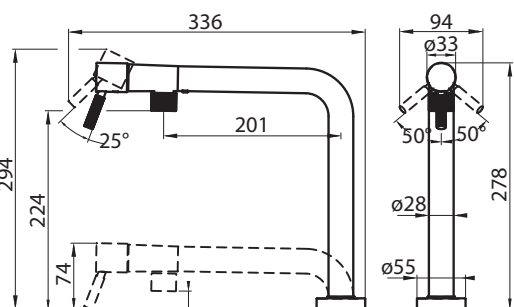

Functions





Accessories: **2** (see page 401)

Technical drawing on page 430

7682 008

FT

FT cut-out: see website

SPT

SPT cut-out: 790x500

- Copper AISI 304
- Dimensions: **803 x 513**
- Cast iron grids and enamelled burner covers
- Electric ignition
- Safety valve with ultra-rapid thermocouple
- Total power 10,250 W
auxiliary: 1,000 W
semirapid: 3x1,750 W
double crown: 4,000 W

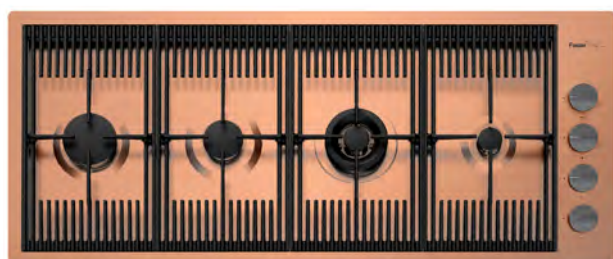

Accessories: **2** (see page 401)

Technical drawing on page 430

7681 008

FT

FT cut-out: see website

SPT

SPT cut-out: 1098x459

- Copper AISI 304
- Dimensions: **1115 x 476**
- Cast iron grids and enamelled burner covers
- Electric ignition
- Safety valve with ultra-rapid thermocouple
- Total power 10,750 W
auxiliary: 1,000 W
semirapid: 1,750 W
rapid: 3,000 W
dual: 5,000 W

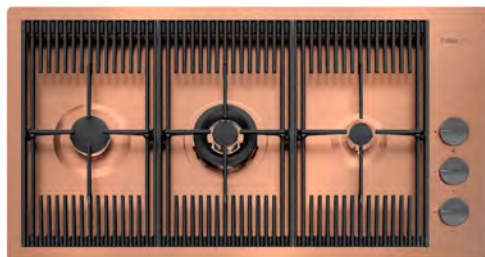

Accessories: **2** (see page 401)

Technical drawing on page 430

7680 008

FT

FT cut-out: see website

SPT

SPT cut-out: 853x459

- Copper AISI 304
- Dimensions: **870 x 476**
- Cast iron grids and enamelled burner covers
- Electric ignition
- Safety valve with ultra-rapid thermocouple
- Total power 7,750 W
auxiliary: 1,000 W
semirapid: 1,750 W
dual: 5,000 W

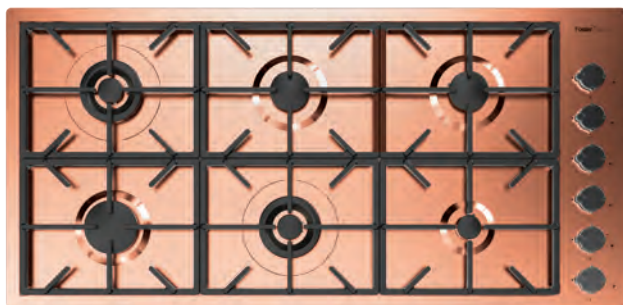

Included: 2x **2** (see page 401)

Technical drawing on page 430

7639 008

FT

FT cut-out: see website

SPT

SPT cut-out: 1134x540

- Copper AISI 304
- Dimensions: **1154x560**
- Cast iron grids and enamelled burner covers
- Electric ignition
- Safety valve with ultra-rapid thermocouple

- Total power 15,900 W
- auxiliary: 1,000 W
- semirapid: 2x1,750 W
- rapid: 3,000 W
- dual: 2x4,200 W



Included: **2** (see page 401)

Technical drawing on page 430

7638 008

FT

FT cut-out: see website

SPT

SPT cut-out: 1036x540

- Copper AISI 304
- Dimensions: **1056x560**
- Cast iron grids and enamelled burner covers
- Electric ignition
- Safety valve with ultra-rapid thermocouple

- Total power 10,950 W
- auxiliary: 2x1,000 W
- semirapid: 1,750 W
- rapid: 3,000 W
- dual: 4,200 W



Included: **2** (see page 401)

Technical drawing on page 430

7640 008

FT

FT cut-out: see website

SPT

SPT cut-out: 1060x470

- Copper AISI 304
- Dimensions: **1080x490**
- Cast iron grids and enamelled burner covers
- Electric ignition
- Safety valve with ultra-rapid thermocouple

- Total power 9,950 W
- auxiliary: 1,000 W
- semirapid: 1,750 W
- rapid: 3,000 W
- dual: 4,200 W



Copper

KE

Code | Version | Characteristics | Price

7601 866



FT cut-out: see website

SPT cut-out: 790x500



- Copper AISI 304
- Dimensions: **803x513**
- Cast iron grids and enamelled burner covers
- Electric ignition
- Safety valve with ultra-rapid thermocouple

- Total power 9,500 W
- auxiliary: 2x1,100 W
- semirapid: 2x1,750 W
- triple crown: 3,800



Accessories: **2** (see page 401)
 Technical drawing on page 430



Copper

Socket holders



Code

Price

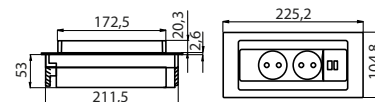
8000 118

Push socket holder slot in Copper PVD stainless steel for built-in installation on worktops.

2 Schuko sockets - 1 USB socket for charging.

Built-in hole: **215 x 88**

PVD | Gold





Cabinet 80



5557 249



installation in worktops: 20 mm
 Dimensions: **756 x 446**
 1 bowl: **716 x 406**

5557 349



installation in worktops: 12 mm
 Dimensions: **740 x 430**
 1 bowl: **716 x 406**

- Cut-out: see website
- Bottom in Gold AISI 304 stainless steel
- 3/2" waste fitting + universal corrugated pipe for installing different overflows

Accessories, technical drawing and automatic waste fittings on page 214

Cabinet 60



5555 249



installation in worktops: 20 mm
 Dimensions: **546 x 446**
 1 bowl: **506 x 406**

5555 349



installation in worktops: 12 mm
 Dimensions: **530 x 430**
 1 bowl: **506 x 406**

- Cut-out: see website
- Bottom in Gold AISI 304 stainless steel
- 3/2" waste fitting + universal corrugated pipe for installing different overflows

Accessories, technical drawing and automatic waste fittings on page 214

Cabinet 60



5554 249



installation in worktops: 20 mm
 Dimensions: **446 x 446**
 1 bowl: **406 x 406**

5554 349



installation in worktops: 12 mm
 Dimensions: **430 x 430**
 1 bowl: **406 x 406**

- Cut-out: see website
- Bottom in Gold AISI 304 stainless steel
- 3/2" waste fitting + universal corrugated pipe for installing different overflows

Accessories, technical drawing and automatic waste fittings on page 214

Cabinet 80**4371 009**
 FT

FT cut-out: see website*

 SPT

SPT cut-out: 718 x 408 R16*

- Gold AISI 304 stainless steel
- Dimensions: **726 x 416** - 1 bowl: **710 x 400**
- 3½" waste fitting
- *The built-in cut-out requires a recess to house the overflow (see website)

Accessories, technical drawing and automatic waste fittings on page 100

Cabinet 80**4371 059**
 ST

cut-out: see website

- Gold AISI 304 stainless steel
- Dimensions: **726 x 416** - 1 bowl: **710 x 400**
- 3½" waste fitting

Accessories, technical drawing and automatic waste fittings on page 220

Cabinet 60**4350 009**
 FT

FT cut-out: see website*

 SPT

SPT cut-out: 508 x 408 R16*

- Gold AISI 304 stainless steel
- Dimensions: **516 x 416** - 1 bowl: **500 x 400**
- 3½" waste fitting
- *The built-in cut-out requires a recess to house the overflow (see website)

Accessories, technical drawing and automatic waste fittings on page 100

Cabinet 60**4350 059** **ST**

cut-out: see website



- Gold AISI 304 stainless steel
- Dimensions: **516 x 416** - 1 bowl: **500 x 400**
- 3½" waste fitting

Accessories, technical drawing and automatic waste fittings on page 220

Cabinet 45**4340 009** **FT**

FT cut-out: see website*

 **SPT**

SPT cut-out: 408 x 408 R16*



- Gold AISI 304 stainless steel
- Dimensions: **416 x 416** - 1 bowl: **400 x 400**
- 3½" waste fitting
- *The built-in cut-out requires a recess to house the overflow (see website)

Accessories, technical drawing and automatic waste fittings on page 100

Cabinet 45**4340 059** **ST**

cut-out: see website



- Gold AISI 304 stainless steel
- Dimensions: **416 x 416** - 1 bowl: **400 x 400**
- 3½" waste fitting

Accessories, technical drawing and automatic waste fittings on page 220

Cabinet 80



1034 059

FT

FT cut-out: see website

SPT

SPT cut-out: 789 x 503

- Gold AISI 304 stainless steel
- Dimensions: **806 x 520** - 1 bowl: **750 x 374**
- Space Push 3 ½" automatic waste fitting (PD)
- Additional holes available
- Three-steps system

Included: **2 Black grids Milanello** (8100 602)
Accessories and technical drawing on page 106

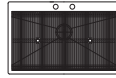

Configuration of
Black grids
flush with bowl

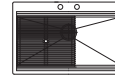

Configuration of
Black grids
at bottom of bowl

Cabinet 90



1034 859

ST

cut-out: 750 x 426

- Gold AISI 304 stainless steel
- Dimensions: **790 x 466** - 1 bowl: **750 x 374**
- SPACE 3 ½" waste fitting
- Three-steps system

Included: **2 Black grids Milanello** (8100 602)
Accessories, technical drawing and automatic
waste fittings on page 226



Configuration of
Black grids
flush with bowl

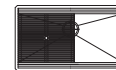

Configuration of
Black grids
at bottom of bowl

Cabinet 80

2157 059

FT

FT cut-out: see website*

SPT

SPT cut-out: 730 x 420*



- Gold AISI 304 stainless steel
- Dimensions: **750 x 440** - 1 bowl: **710 x 400**
- 3/2" waste fitting

* The built-in cut-out requires a recess to house the overflow (see website)

Accessories, technical drawing and automatic waste fittings on page 162

Cabinet 80

2157 859

ST

cut-out: 710 x 400 R15



- Gold AISI 304 stainless steel
- Dimensions: **750 x 440** - 1 bowl: **710 x 400**
- 3/2" waste fitting

• Also available in version

Vintage
2157 889



Accessories, technical drawing and automatic waste fittings on page 270

Cabinet 60

2155 059

FT

FT cut-out: see website*

SPT

SPT cut-out: 520 x 420*



- Gold AISI 304 stainless steel
- Dimensions: **540 x 440** - 1 bowl: **500 x 400**
- 3/2" waste fitting

* The built-in cut-out requires a recess to house the overflow (see website)

Accessories, technical drawing and automatic waste fittings on page 162

Code	Version	Characteristics	Price
------	---------	-----------------	-------

Cabinet 60

2155 859  ST incasso: 500 x 400 R15



- Gold AISI 304 stainless steel
- Dimensions: **540 x 440** - 1 bowl: **500 x 400**
- 3½" waste fitting

• Also available in version

Vintage
2155 889



Accessories, technical drawing and automatic waste fittings on page 270

Cabinet 60

2156 859  ST cut-out: 400 x 400 R15



- Gold AISI 304 stainless steel
- Dimensions: **440 x 440** - 1 bowl: **400 x 400**
- 3½" waste fitting

• Also available in version

Vintage
2156 889



Accessories, technical drawing and automatic waste fittings on page 270

Cabinet 45



1130 069

FT

FT cut-out: see website*

SPT

SPT cut-out: Ø 410*

- Gold AISI 304 stainless steel
- Dimensions: Ø 425 - 1 bowl: Ø 380
- 3½” waste fitting
- *The built-in hole requires a cut-out to house the overflow

Accessories, technical drawing and automatic waste fittings on page 132

Cabinet 60



1130 869

ST

cut-out: Ø 380

- Gold AISI 304 stainless steel
- Dimensions: Ø 425 - 1 bowl: Ø 380
- 3½” waste fitting

Accessories, technical drawing and automatic waste fittings on page 252

Accessories and automatic waste fittings

Z7

Stainless steel perforated tray
21.5x38 cm
8151 009

NEW



To be used in combination with

N3

8644 101

K2

8100 037

K1

8100 627

PD

8407121



NEW

Space Push Gold **automatic waste fitting** with round push remote control and perimeter overflow. Double plug included: Stainless steel space and “basket”.





Characteristics

Code

Price

- Single-lever mixer tap
- Swivel tap body and flexible shower head
- Strengthening plate: \varnothing 50 mm

8424 859

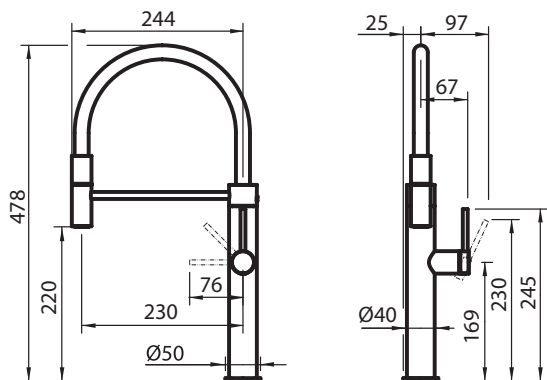

Characteristics





Characteristics

- Single-lever mixer tap
- Swivel tap body and extractable shower-head
- Strengthening plate: \varnothing 50 mm

Code

8498 859

Price

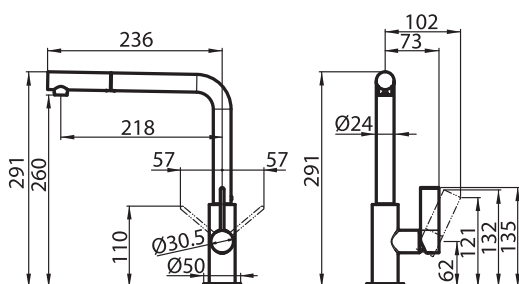

Functions





Characteristics

- Single-lever mixer tap
- Swivel tap body
- Strengthening plate: \varnothing 50 mm

Code

8497 700

Price

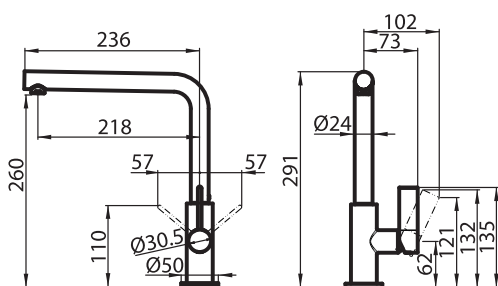

Functions





Characteristics

Code

Price

- Single-lever mixer tap
- Up&down collapsible swivel tap body
- Strengthening plate: \varnothing 55 mm

8524 009

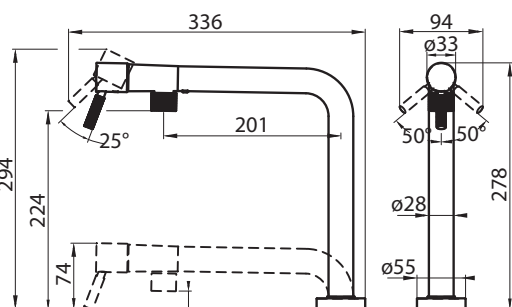

Functions





Accessories: **2** (see page 401)

Technical drawing on page 430

7682 009

FT

FT cut-out: see website

SPT

SPT cut-out: 790x500

- Gold AISI 304
- Dimensions: **803 x 513**
- Cast iron grids and enamelled burner covers
- Electric ignition
- Safety valve with ultra-rapid thermocouple

- Total power 10,250 W
auxiliary: 1,000 W
semirapid: 3x1,750 W
double crown: 4,000 W

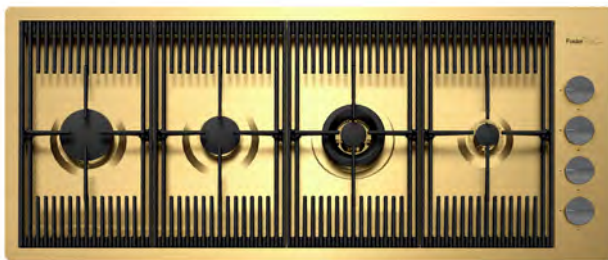

Accessories: **2** (see page 401)

Technical drawing on page 430

7681 009

FT

FT cut-out: see website

SPT

SPT cut-out: 1098x459

- Gold AISI 304
- Dimensions: **1115 x 476**
- Cast iron grids and enamelled burner covers
- Electric ignition
- Safety valve with ultra-rapid thermocouple

- Total power 10,750 W
auxiliary: 1,000 W
semirapid: 1,750 W
rapid: 3,000 W
dual: 5,000 W

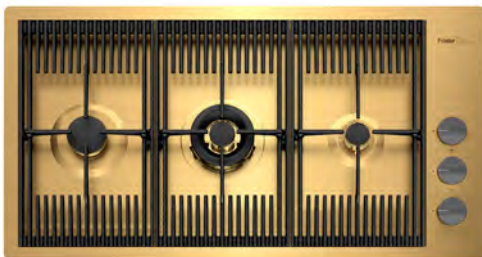

Accessories: **2** (see page 401)

Technical drawing on page 430

7680 009

FT

FT cut-out: see website

SPT

SPT cut-out: 853x459

- Gold AISI 304
- Dimensions: **870 x 476**
- Cast iron grids and enamelled burner covers
- Electric ignition
- Safety valve with ultra-rapid thermocouple

- Total power 7,750 W
auxiliary: 1,000 W
semirapid: 1,750 W
dual: 5,000 W



Included: 2x **2** (see page 401)

Technical drawing on page 430

7639 009

FT

FT cut-out: see website

SPT

SPT cut-out: 1134x540

- Gold AISI 304
- Dimensions: **1154x560**
- Cast iron grids and enamelled burner covers
- Electric ignition
- Safety valve with ultra-rapid thermocouple

- Total power 15,900 W
- auxiliary: 1,000 W
- semirapid: 2x1,750 W
- rapid: 3,000 W
- dual: 2x4,200 W



Included: **2** (see page 401)

Technical drawing on page 430

7638 009

FT

FT cut-out: see website

SPT

SPT cut-out: 1036x540

- Gold AISI 304
- Dimensions: **1056x560**
- Cast iron grids and enamelled burner covers
- Electric ignition
- Safety valve with ultra-rapid thermocouple

- Total power 10,950 W
- auxiliary: 2x1,000 W
- semirapid: 1,750 W
- rapid: 3,000 W
- dual: 4,200 W



Included: **2** (see page 401)

Technical drawing on page 430

7640 009

FT

FT cut-out: see website

SPT

SPT cut-out: 1060x470

- Gold AISI 304
- Dimensions: **1080x490**
- Cast iron grids and enamelled burner covers
- Electric ignition
- Safety valve with ultra-rapid thermocouple

- Total power 9,950 W
- auxiliary: 1,000 W
- semirapid: 1,750 W
- rapid: 3,000 W
- dual: 4,200 W



Gold

KE

Code

Version

Characteristics

Price

7601 932

FT

FT cut-out: see website

SPT

SPT cut-out: 790x500



- Gold AISI 304
- Dimensions: **803x513**
- Cast iron grids and enamelled burner covers
- Electric ignition
- Safety valve with ultra-rapid thermocouple

- Total power 9,500 W
- auxiliary: 2x1,100 W
- semirapid: 2x1,750 W
- triple crown: 3,800



Accessories: **2** (see page 401)

Technical drawing on page 430



Gold

Socket holders

Code

Price

8000 119

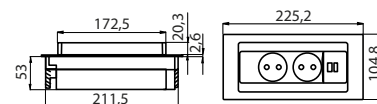

Push socket holder slot in Gold PVD stainless steel for built-in installation on worktops.
2 Schuko sockets - 1 USB socket for charging.
Built-in hole: **215 x 88**

PVD | Brandy





Quadra R12



Cabinet 80



Included: **1 grid** (8100 617)
Accessories, technical drawing and automatic waste fittings on page 124

Code	Version	Characteristics	Price
------	---------	-----------------	-------

1717 055

FT

FT cut-out: see website*

SPT

SPT cut-out: 730 x 430*

- Brandy AISI 304 stainless steel
- Dimensions: **750 x 440** - 1 bowl: **710 x 400**
- 3½" waste fitting
- *The hole requires a cut-out to house the overflow (only for worktops >30)

• Also available in version

Brandy Fumè
1717 015

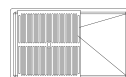

Configuration of
Black grids
flush with bowl



Configuration of
Black grids
at bottom of bowl

Cabinet 80

1717 855



ST

cut-out: 710 x 400 R12



- Brandy AISI 304 stainless steel
- Dimensions: **750 x 440** - 1 bowl: **710 x 400**
- 3.5" waste fitting

• Also available in version

Brandy Fumè
1717 815



Included: **1 grid** (8100 617)
Accessories, technical drawing and automatic waste fittings on page 244

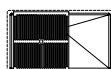

Configuration of Black grids flush with bowl

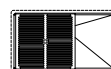

Configuration of Black grids at bottom of bowl

Cabinet 60

1715 055



FT

FT cut-out: see website*



- Brandy AISI 304 stainless steel
- Dimensions: **540 x 440** - 1 bowl: **500 x 400**
- 3½" waste fitting
- *The hole requires a cut-out to house the overflow (only for worktops >30)

• Also available in version

Brandy Fumè
1715 015



Included: **1 grid** (8100 617)
Accessories, technical drawing and automatic waste fittings on page 124



Configuration of Black grids flush with bowl



Configuration of Black grids at bottom of bowl

Cabinet 60

1715 855



ST

cut-out: 500 x 400 R12



- Brandy AISI 304 stainless steel
- Dimensions: **540 x 440** - 1 bowl: **500 x 400**
- 3.5" waste fitting

• Also available in version

Brandy Fumè
1715 815



Included: **1 grid** (8100 617)
Accessories, technical drawing and automatic waste fittings on page 244



Configuration of Black grids flush with bowl





Configuration of Black grids at bottom of bowl



Cabinet 80



Code	Version	Characteristics	Price
2157 055	 FT	FT cut-out: see website*	
	 SPT	SPT cut-out: 730 x 420*	

- Brandy AISI 304 stainless steel
- Dimensions: **750 x 440** - 1 bowl: **710 x 400**
- 3½" waste fitting

* The built-in cut-out requires a recess to house the overflow (see website)

Accessories, technical drawing and automatic waste fittings on page 162

Cabinet 80

2157 855



cut-out: 710 x 400 R15



- Brandy AISI 304 stainless steel
- Dimensions: **750 x 440** - 1 bowl: **710 x 400**
- 3½” waste fitting

Accessories, technical drawing and automatic waste fittings on page 270

Cabinet 60

2155 055



FT cut-out: see website*



SPT cut-out: 520 x 420*



- Brandy AISI 304 stainless steel
- Dimensions: **540 x 440** - 1 bowl: **500 x 400**
- 3½” waste fitting

* The built-in cut-out requires a recess to house the overflow (see website)

Accessories, technical drawing and automatic waste fittings on page 162

Cabinet 60

2155 855



cut-out: 500 x 400 R15



- Brandy AISI 304 stainless steel
- Dimensions: **540 x 440** - 1 bowl: **500 x 400**
- 3½” waste fitting

Accessories, technical drawing and automatic waste fittings on page 270

PVD | Sunset







Characteristics

Code

Price

- Single-lever mixer tap
- Swivel tap body and flexible shower head
- Strengthening plate: \varnothing 50 mm

8424 851

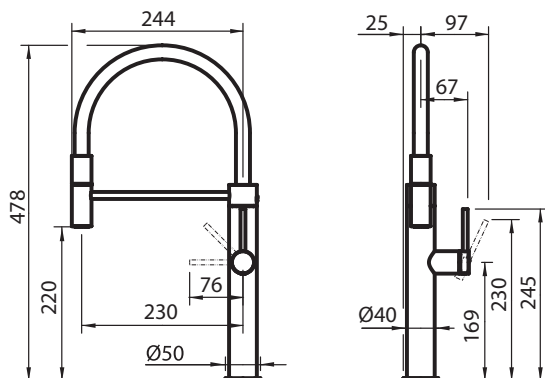

Characteristics





Characteristics

Code

Price

- Single-lever mixer tap
- Swivel tap body and extractable shower-head
- Strengthening plate: \varnothing 50 mm

8498 851

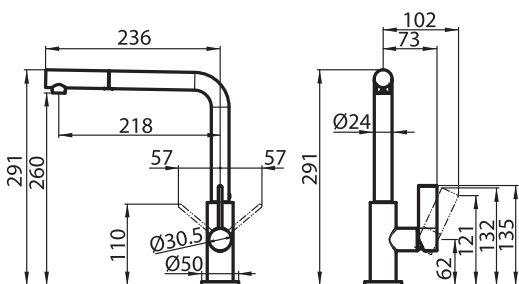

Functions



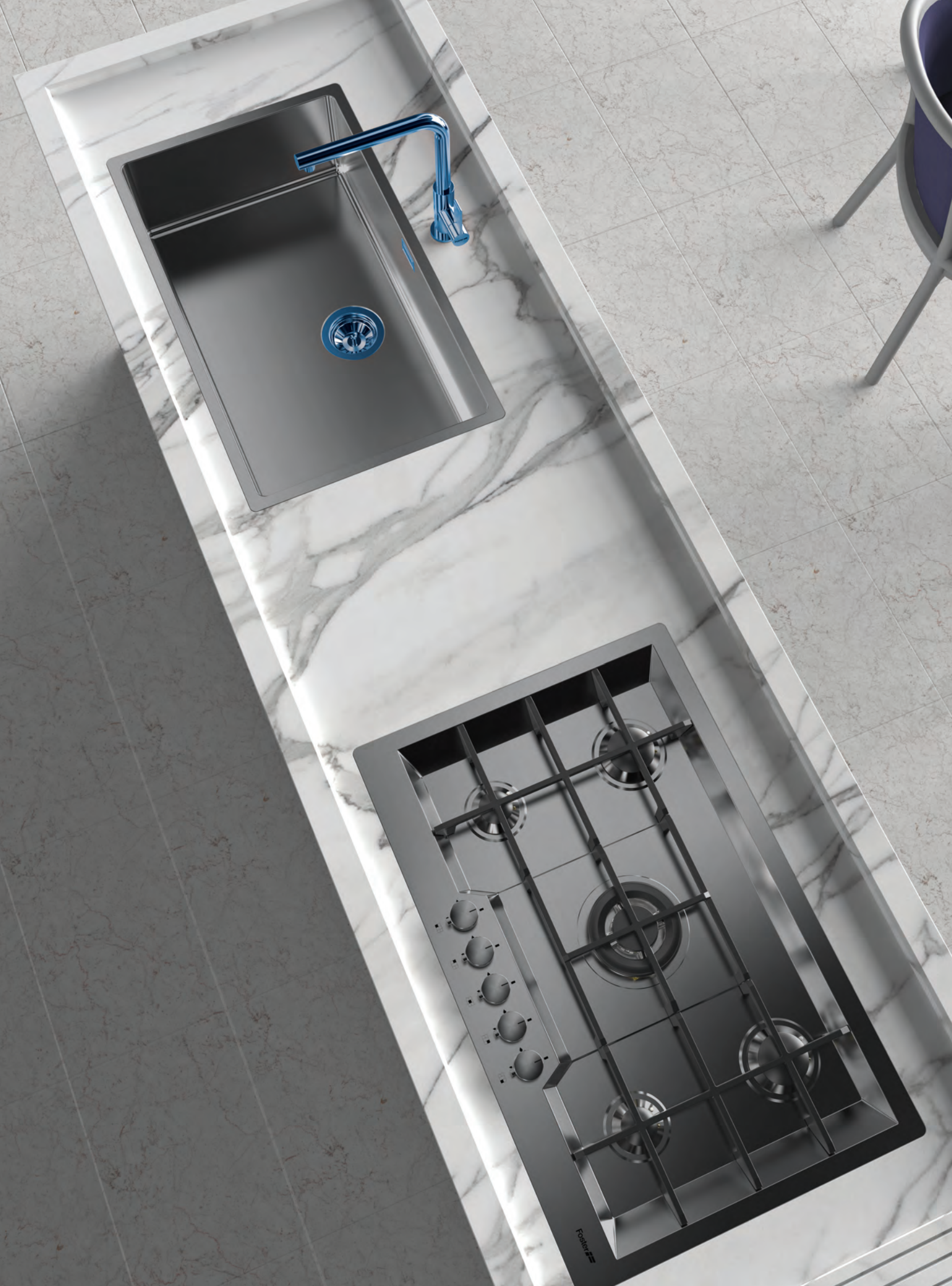



8403 325

3.5" Sunset waste fitting overflow with overflow plate



Sunset PVD is the newest addition to the Foster PVD range

Sunset PVD features an iridescent, shimmering colouring that creates shades ranging from blue to purple, like the most vibrant sunsets.











Sinks | Top-mount







96	Phantom 	154	KE 
102	Milanello workstation	164	Stripe
108	Foster Milano	168	EVO Series 
114	Quadra EVO 	174	Elettra
120	Quadra R12 	178	FM
126	Quadra 	180	FM Marine
132	Circolari 	184	Big Bowl
134	S4001 	188	Uragano
142	New Wave	189	Tornado
146	Fortyfour	192	Angolare 
148	Master	196	S1000
152	FL	202	Single bowl S1000 

Phantom **NEW**
top-mount | flush-mount



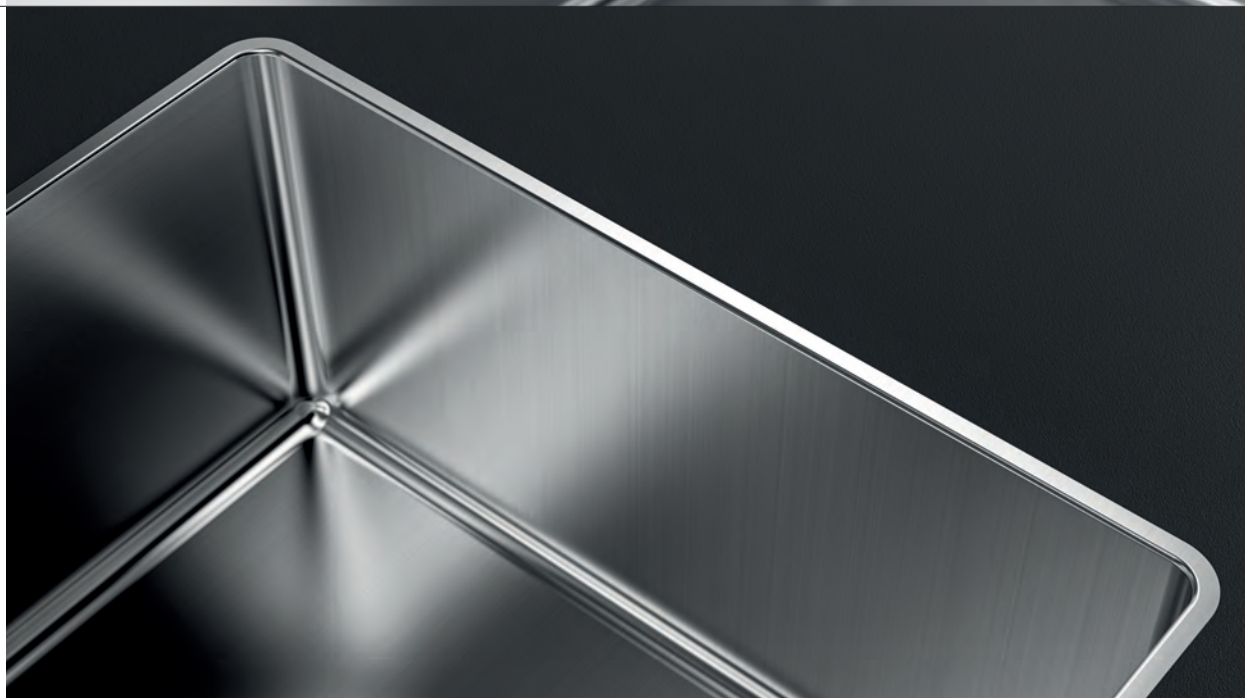

Thin edge

almost invisible creates a sense of continuity with the worktop, adding elegance and design

Sinks with bowls R12

Phantom NEW

top-mount | flush-mount

Cabinet 80



Accessories, technical drawing and automatic waste fittings on page 100

Code	Version	Characteristics	Price
------	---------	-----------------	-------

4371 001	 FT	FT cut-out: see website*	
	 SPT	SPT cut-out: 718 x 408 R16*	

- Satin finish AISI 304 stainless steel
- Dimensions: **726 x 416** - 1 bowl: **710 x 400**
- 3½" waste fitting
- *The built-in cut-out requires a recess to house the overflow (see website)

• Also available in version **PVD**

Gun Metal
4371 006



page 23

Copper
4371 008



page 47

Gold
4371 009



page 65

Cabinet 60



Accessories, technical drawing and automatic waste fittings on page 100

4350 001	 FT	FT cut-out: see website*	
	 SPT	SPT cut-out: 508 x 408 R16*	

- Satin finish AISI 304 stainless steel
- Dimensions: **516 x 416** - 1 bowl: **500 x 400**
- 3½" waste fitting
- *The built-in cut-out requires a recess to house the overflow (see website)

• Also available in version **PVD**

Gun Metal
4350 006



page 23

Copper
4350 008



page 47

Gold
4350 009



page 65

Cabinet 45



Accessories, technical drawing and automatic waste fittings on page 100

4340 001	 FT	FT cut-out: see website*	
	 SPT	SPT cut-out: 408 x 408 R16*	

- Satin finish AISI 304 stainless steel
- Dimensions: **416 x 416** - 1 bowl: **400 x 400**
- 3½" waste fitting
- *The built-in cut-out requires a recess to house the overflow (see website)

• Also available in version **PVD**

Gun Metal
4340 006



page 24

Copper
4340 008



page 48

Gold
4340 009



page 66



* Thin edge of only 8 mm

B3

Black grid
39 x 42 cm
8100 617



B8

Black grid
38 x 69 cm
8100 653



B6

Black grid
38 x 38 cm
8100 651

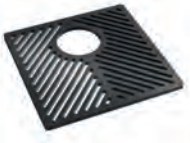

B7

Black grid
38 x 48 cm
8100 652



K7

Iroko wood chopping board kit 42 x 31.7 cm with stainless steel colander
8644 044



L4

Glass chopping board
23x41 cm
8631 300

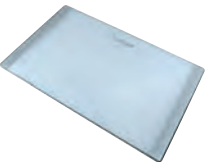

N2

HDPE chopping board
27.2x42.5 cm
8657 001



N3

HDPE Twin chopping board 31.7x42.5
8644 101



O2

White bowl
27.2x41.4 cm
8153 100



K8 *

Graters kit with frame and food tray
8159 101



R2

Stainless steel basket
34x40 cm
8611 000



R3

Stainless steel basket
40x40
8612 000



T1

Stainless steel plate rack 25x42.5 cm
8100 201



T2 *

Stainless steel plate rack 21.4x37.9 cm
8100 303

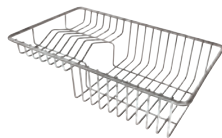

Z2 *

Stainless steel perforated tray 21.5x38 cm
8151 000



Also available in version PVD



Gun Metal
8151 006



Copper
8151 008



Gold
8151 009

4371 001 **B3 B8 K7 L4 N2 N3 O2 K8**
R2 R3 T1 T2 Z2

4350 001 **B3 K7 L4 N2 N3 O2 K8 R2**
R3 T1 T2 Z2 B7

4340 001 **B3 K7 L4 N2 N3 O2 K8 R2**
R3 T1 T2 Z2 B6

optional automatic waste fittings

4371 001 **PL PP PA PE PM**

4350 001 **PL PP PA PE PM**

4340 001 **PL PP PA PE PM**

See page 298

* only usable in combination with chopping board N3

4371 001

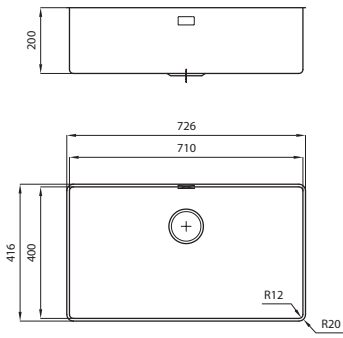

4350 001

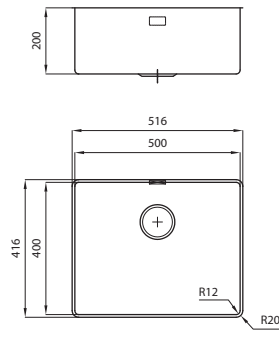

4340 001

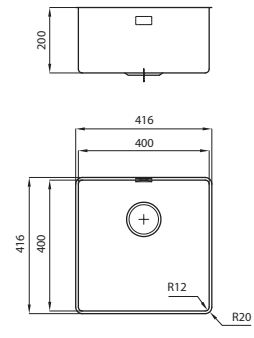

Milanello workstation

top-mount | flush-mount



archiproducts[®]
DESIGN AWARDS
—
WINNER 2019



Foster

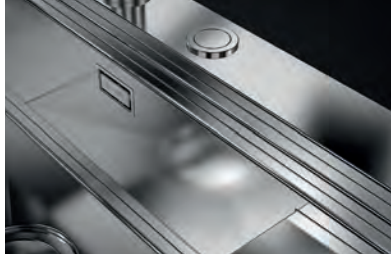

Three-steps system

On the topmost step, the Black grids slide: a large surface to rinse, drain and work.

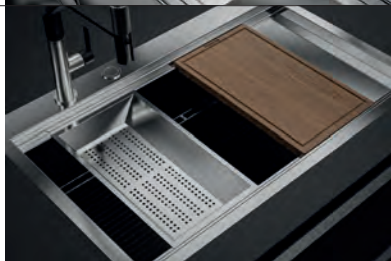

Complete range of sliding accessories

The second step supports a combination of accessories, which make each operation practical: rinsing, draining, slicing, grating... everything can be done inside the sink.



Protection grids on the bottom

The third step to support the black grids is on the bottom of the bowl. For rinsing without touching the bottom, or for placing items without scratching the steel.



Milanello workstation

top-mount | flush-mount

Code

Version

Characteristics

Price

Cabinet 120



1043 051 rh
1043 052 lh



FT cut-out: see website
SPT cut-out: 1158 x 503

- Satin finish AISI 304 stainless steel
- Dimensions: **1175 x 520** - 1 bowl: **855 x 374**
- Space Push 3½" automatic waste fitting (PP)
- Additional holes available
- Three-steps system

Included: **3 Black grids Milanello** (8100 602)
Accessories and technical drawing on page 106

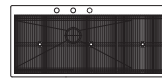

Configuration of Black grids flush with bowl

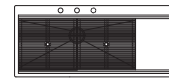

Configuration of Black grids at bottom of bowl

Cabinet 80



1040 051 rh
1040 052 lh



FT cut-out: see website
SPT cut-out: 789 x 503

- Satin finish AISI 304 stainless steel
- Dimensions: **806 x 520** - 1 bowl: **430 x 374**
- Space Push 3½" automatic waste fitting (PP)
- Additional holes available
- Three-steps system

Included: **2 Black grids Milanello** (8100 602)
Accessories and technical drawing on page 106

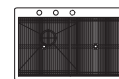

Configuration of Black grids flush with bowl

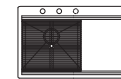

Configuration of Black grids at bottom of bowl

Cabinet 80



1034 050



FT cut-out: see website
SPT cut-out: 789 x 503

- Satin finish AISI 304 stainless steel
- Dimensions: **806 x 520** - 1 bowl: **750 x 374**
- Space Push 3½" automatic waste fitting (PP)
- Additional holes available
- Three-steps system

• Also available in version **PVD**

Gun Metal
1034 056



page 25

Copper
1034 058



page 49

Gold
1034 059



page 67

Included: **2 Black grids Milanello** (8100 602)
Accessories and technical drawing on page 106

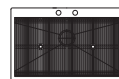

Configuration of Black grids flush with bowl

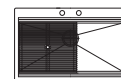

Configuration of Black grids at bottom of bowl

Milanello workstation

top-mount | flush-mount

Cabinet 60



Included: **1 Black grid Milanello** (8100 602)
Accessories and drawing on page 106



Configuration of
Black grid
flush with bowl



Configuration of
Black grid
at bottom of bowl

Code	Version	Characteristics	Price
1031 050	FT	FT cut-out: see website	
	SPT	SPT cut-out: 469 x 503	

- Satin finish AISI 304 stainless steel
- Dimensions: **486 x 520** - 1 bowl: **430 x 374**
- Space Push 3½" automatic waste fitting (PP)
- Three-steps system

Milanello workstation | accessories

optional sliding accessories under the grids



Z3
Stainless steel perforated tray
21.5x40 cm
8156 000

LEV. 2



T8
Stainless steel plate rack
21.4x37.2 cm
8100 306

LEV. 2



P2
Chopping board
39.5 x 22.5 cm
in walnut wood
8642 004

LEV. 2

other optional accessories

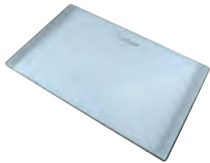

L4
Glass chopping board
23x41 cm
8631 300

LEV. 1



N2
HDPE chopping board
27.2x42.5 cm
8657 001

LEV. 1



N3
HDPE Twin chopping board
31.7x42.5 cm
8644 101

LEV. 1



K8 *
Graters kit with frame
and food tray
8159 101



T2 *
Stainless steel plate rack
21.4x37.9 cm
8100 303



Z2 *
Stainless steel perforated tray
21.5x38 cm
8151 000

Also available in version PVD



Gun Metal
8151 006



Copper
8151 008



Gold
8151 009



K7
Iroko wood chopping board kit
42 x 31.7 cm with stainless steel colander
8644 044

LEV. 1



B5
Black grid
37.2 x 42.4 cm
8100 602

LEV. 1 - 3
(included)

1043 051 Z3 T8 L5 N2 N3 K8 T2 Z2
1043 052 K7 P2 B5

1040 051 Z3 T8 L5 N2 N3 K8 T2 Z2
1040 052 K7 P2 B5

1034 050 Z3 T8 L5 N2 N3 K8 T2 Z2
K7 P2 B5

1031 050 Z3 T8 L5 N2 N3 K8 T2 Z2
K7 P2 B5

* only usable in combination with accessories N3, K1 and K2

1043 051 rh | 1043 052 lh

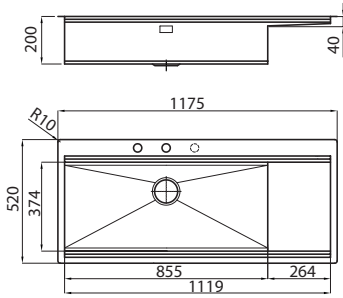

1040 051 rh | 1040 052 lh

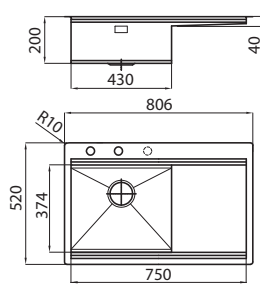

1034 050

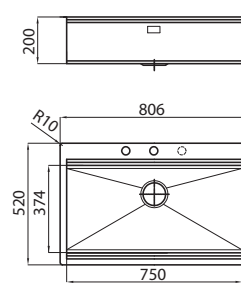

1031 050

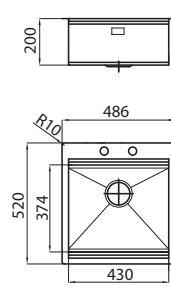

Drawing of position of accessories on steps

The "steps" system makes the combined use of countless accessories possible. Grids, chopping boards, tool holders, trays and containers of various sizes can be moved around the work area with a simple gesture and can be stacked so that they are always within reach.

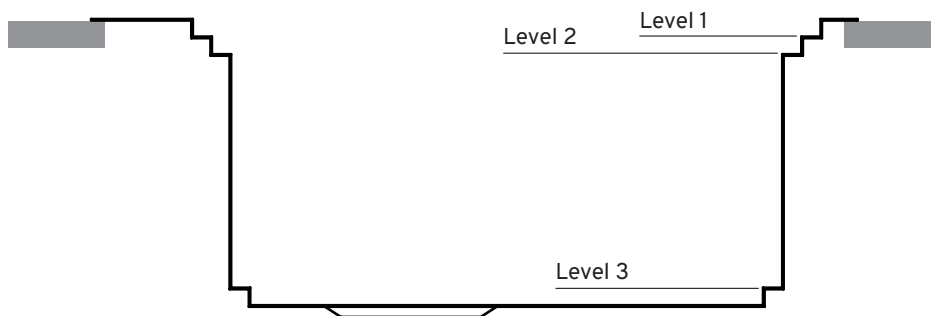

Foster Milano

top-mount | flush-mount | Q4



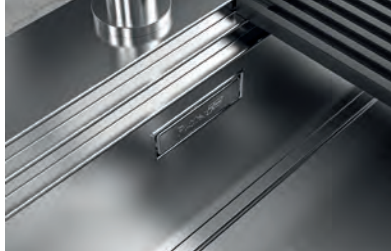

Large bowl with Three-steps system:
All the space you need as a sink or work area

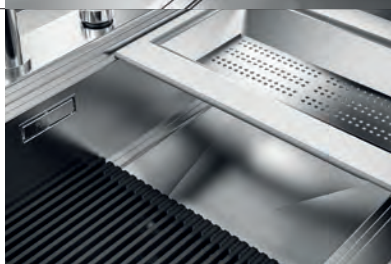

Complete range of sliding accessories



Protection grids on the bottom

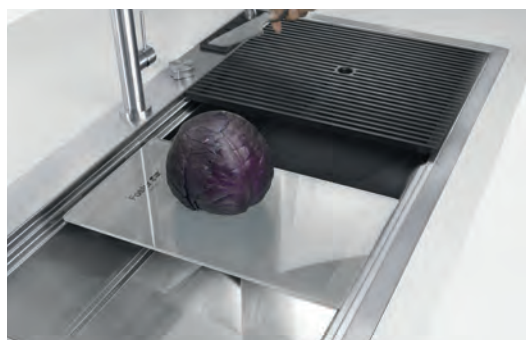

Foster Milano

top-mount | flush-mount | Q4

Cabinet 120



Knives-holder element included
Accessories and technical drawing on page 112

Code	Version	Characteristics	Price
------	---------	-----------------	-------

1018 055	Q4	Q4 cut-out: 1004 x 540	
1017 055	FT SPT	FT cut-out: see website SPT cut-out: 1004 x 540	

- Satin finish AISI 304 stainless steel
- Dimensions: **1024 x 560** - 1 bowl: **968 x 400**
- Space Milano 3½" automatic waste fitting
- Three-steps system
- Additional holes available

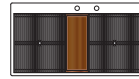

Configuration of
Black grids
flush with bowl

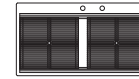

Configuration of
Black grids
at bottom of bowl

Cabinet 120



Accessories and technical drawing on page 112

1018 050	Q4	Q4 cut-out: 1004 x 540	
1017 050	FT SPT	FT cut-out: see website SPT cut-out: 1004 x 540	

- Satin finish AISI 304 stainless steel
- Dimensions: **1024 x 560** - 1 bowl: **968 x 400**
- Space Milano 3½" automatic waste fitting
- Three-steps system
- Additional holes available

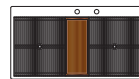

Configuration of
Black grids
flush with bowl



Configuration of
Black grids
at bottom of bowl

Cabinet 90



Accessories and technical drawing on page 112

1025 050	Q4	Q4 cut-out: 826 x 540	
1024 050	FT SPT	FT cut-out: see website SPT cut-out: 826 x 540	

- Satin finish AISI 304 stainless steel
- Dimensions: **846 x 560** - 1 bowl: **790 x 400**
- Space Milano 3½" automatic waste fitting
- Three-steps system
- Additional holes available

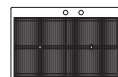

Configuration of
Black grids
flush with bowl



Configuration of
Black grids
at bottom of bowl



Foster Milano

top-mount | flush-mount | Q4

Cabinet 60



Accessories and technical drawing on page 112

Code	Version	Characteristics	Price
1012 050	 Q4	Q4 cut-out: 498 x 540	
1011 050	 FT	FT cut-out: see website	
	 SPT	SPT cut-out: 498 x 540	

- Satin finish AISI 304 stainless steel
- Dimensions: **518 x 400** - 1 bowl: **462 x 400**
- Space Milano 3½" automatic waste fitting
- Three-steps system



Configuration of
Black grids
flush with bowl



Configuration of
Black grids
at bottom of bowl

Foster Milano | accessories

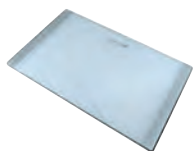

L4

Glass chopping board
23 x 41 cm
8631 300

LEV. 2



P6

Walnut wood chop-
ping board
18 x 44 cm
8642 000

LEV. 1



N3

HDPE Twin
chopping board
31.7 x 42.5 cm
8644 101

LEV. 2



K8 *

Graters kit with frame
and food collection tray
8159 101

LEV. 2



B9

Black grid
39.2 x 44.8 cm
8100 600

LEV. 1 - 3



T2 *

Stainless steel plate
rack 21.4 x 37.9 cm
8100 303

LEV. 2



Z2 *

Stainless steel
perforated tray 21.5
x 38 cm
8151 000

LEV. 2

Also available in version **PVD**



Gun Metal
8151 006



Copper
8151 008



Gold
8151 009



O2

White bowl
41.4x27.2 cm
8153 100



K7

Iroko wood chopping
board kit 42 x 31.7 cm
with
stainless steel col-
ander
8644 044

LEV. 2



K3

Spice holder kit
44.8 x 10 cm
8100 620

LEV. 1



K4

Bottle holder kit
44.8 x 14 cm
8100 621

LEV. 1



K5

Bowls kit
44.8 x 18 cm
8100 622

LEV. 1

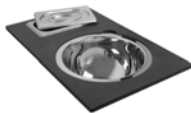

K6

Tray+bowl kit
44.8 x 28 cm
8100 628

LEV. 1



K2

Chopping board kit
44.8 x 28.9 cm
8100 037

LEV. 1



X1 **

Stainless steel
perforated tray
12.6 x 12.1 cm
8151 001

X3 ***



Knife holder
8100 030

1017 055 **P6 B9 L4 N3 K8 T2 Z2 O2**
K2 K3 K4 K5 K6 K7 X1 X3

1017 050 **P6 B9 L4 N3 K8 T2 Z2 O2**
K2 K3 K4 K5 K6 K7 X1 X3

1024 050 **P6 B9 L4 N3 K8 T2 Z2 O2**
K2 K3 K4 K5 K6 K7 X1 X3

1011 050 **P6 B9 L4 N3 K8 T2 Z2 O2**
K2 K3 K4 K5 K6 K7 X1 X3

* only usable in combination with chopping board N3
** only usable in combination with kit K2
*** only usable in combination with kit K4

1017 055

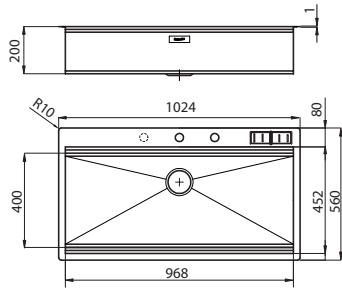

1017 050

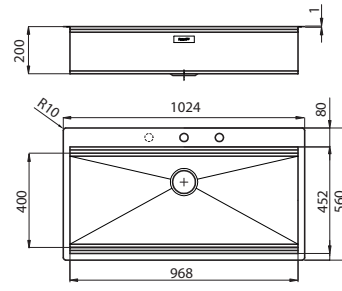

1024 050

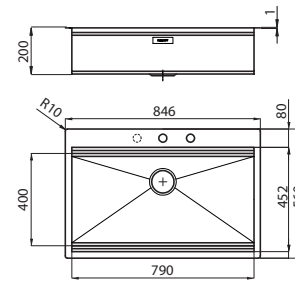

1011 050

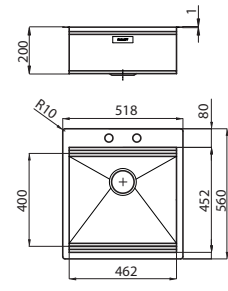

1018 055

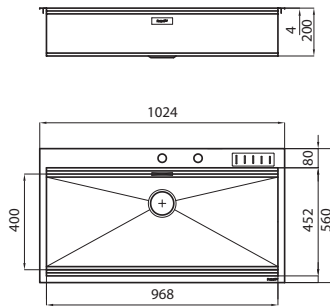

1018 050

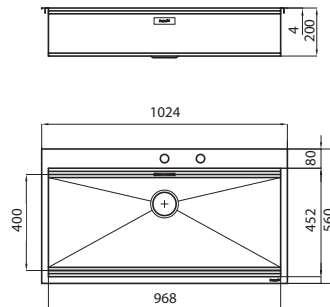

1025 050

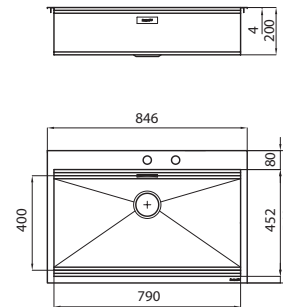

1012 050

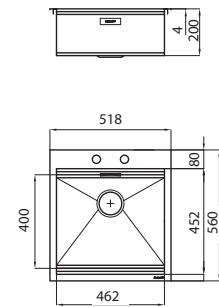

Drawing of position of accessories on steps

The “steps” system makes the combined use of countless accessories possible. Grids, chopping boards, tool holders, trays and containers of various sizes can be moved around the work area with a simple gesture and can be stacked so that they are always within reach.

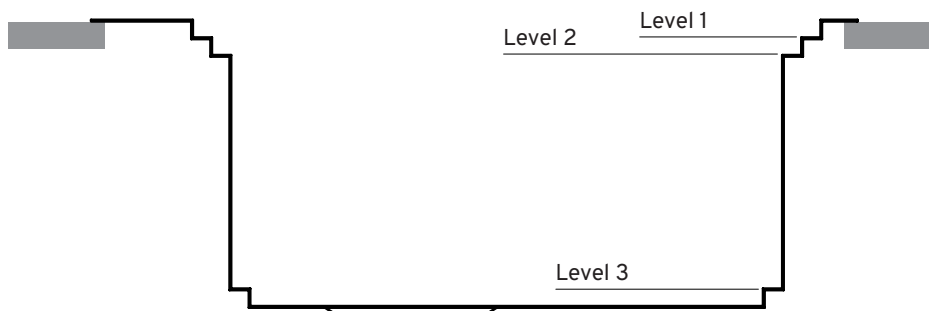

Quadra EVO NEW
top-mount | flush-mount





Complete range of accessories



Protection grids on the bottom

At the bottom the grids rest on a perimeter step for rinsing without touching the bottom, or for placing items without scratching the steel.



Grid included

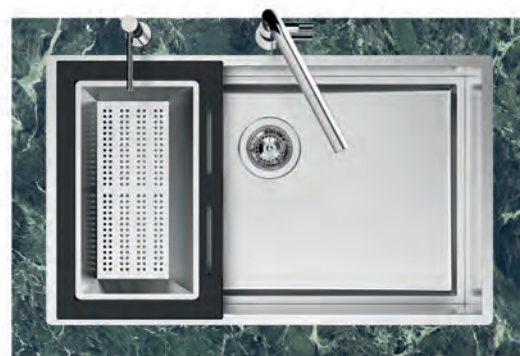
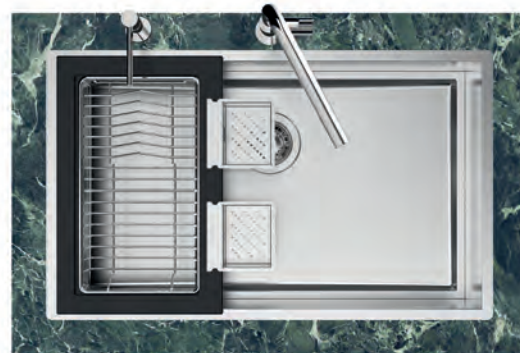
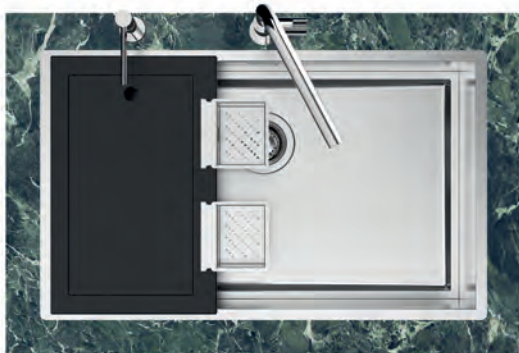

Quadra EVO NEW

top-mount | flush-mount

Cabinet 80



Included: **2 grids** (8100 614 - 8100 615)
Accessories, technical drawing and automatic waste fittings on page 118

Code	Version	Characteristics	Price
------	---------	-----------------	-------

1257 050	 FT	FT cut-out: see website*	
	 SPT	SPT cut-out: 760 x 450*	

- Satin finish AISI 304 stainless steel
- Dimensions: **780 x 470** - 1 bowl: **740 x 430**
- 3½" waste fitting
- * The hole requires a cut-out to house the overflow (see website)

• Also available in version **PVD** **Gun Metal** **1257 056**



page 26



Configuration of Black grids flush with bowl

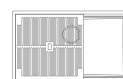

Configuration of Black grids at bottom of bowl

Cabinet 60



Included: **1 grid** (8100 615)
Accessories, technical drawing and automatic waste fittings on page 118

1255 050	 FT	FT cut-out: see website*	
	 SPT	SPT cut-out: 550 x 450*	

- Satin finish AISI 304 stainless steel
- Dimensions: **570 x 470** - 1 bowl: **530 x 430**
- 3½" waste fitting
- * The hole requires a cut-out to house the overflow (see website)

• Also available in version **PVD** **Gun Metal** **1255 056**



page 26



Configuration of Black grids flush with bowl





Configuration of Black grids at bottom of bowl

Cabinet 60



Included: **1 grid** (8100 615)
Accessories, technical drawing and automatic waste fittings on page 118

1254 050	 FT	FT cut-out: see website*	
	 SPT	SPT cut-out: 450 x 450*	

- Satin finish AISI 304 stainless steel
- Dimensions: **470 x 470** - 1 bowl: **430 x 430**
- 3½" waste fitting
- * The hole requires a cut-out to house the overflow (see website)

• Also available in version **PVD** **Gun Metal** **1254 056**



page 27



Configuration of Black grids flush with bowl

Quadra EVO | Grid configuration drawing

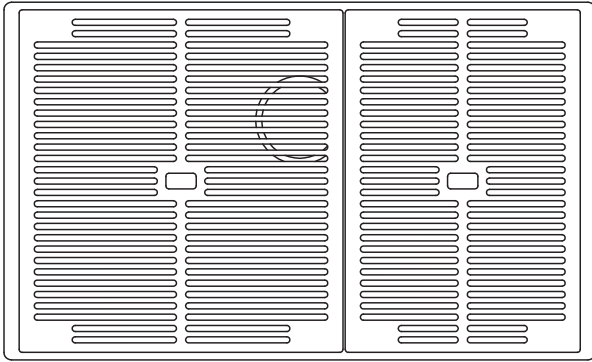

Configuration of **Black grids** 8100 615 + 8100 614 flush with bowl

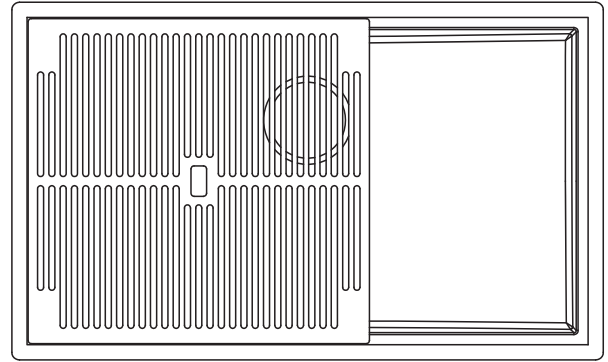

Configuration of **Black grid** 8100 615 resting on perimeter step on the bottom

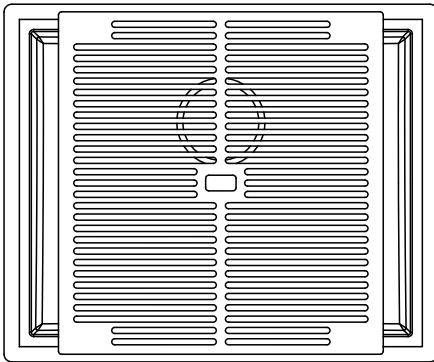

Configuration of **Black grid** 8100 615 flush with bowl

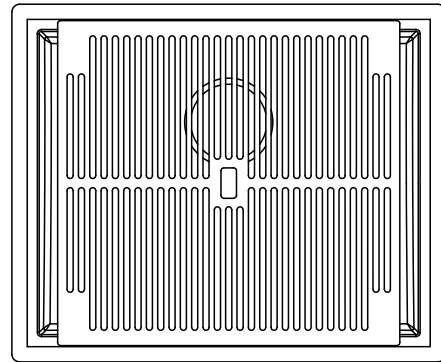

Configuration of **Black grid** 8100 615 resting on perimeter step on the bottom

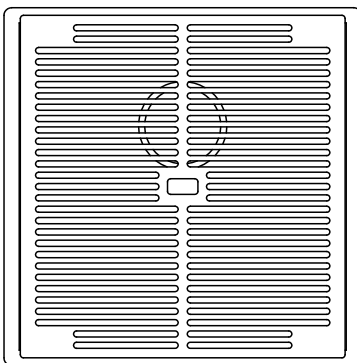

Configuration of **Black grid** 8100 615 flush with bowl

Quadra EVO NEW



B1
Black grid
42.7 x 45 cm
8100 615

LEV. 1 - 2



B2
Black grid
31 x 45 cm
8100 614

LEV. 1



K2
Kit
44.8 x 28.9 cm
8100 037

LEV. 1



T2 *
Stainless steel plate
rack 21.4x37.9 cm
8100 303



Z2 *
Stainless steel
perforated tray
21.5x38 cm
8151 000

Also available in version PVD



Gun Metal
8151 006



Copper
8151 008



Gold
8151 009



K8 *
Graters kit
with frame
and food collection
tray
8159 101



X1 *
Stainless steel
perforated tray
12.6 x 12.1 cm
8151 001



O2
White bowl
41.4x27.2 cm
8153 100

On the bottom

accessories

1257 050 **B1 B2 K2 T2 K8 X1**
O2 Z2

1255 050 **B1 K2 T2 Z2 K8 X1**
O2

1254 050 **B1 K2 T2 Z2 K8 X1**
O2

optional automatic waste fittings

1257 050 **PL PP PM PA**

1255 050 **PL PP PM PA**

1254 050 **PL PP PM PA**

See page 298

* only usable in combination with kit K2

1257 050

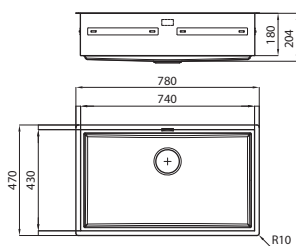

1255 050

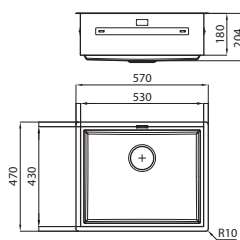

1254 050

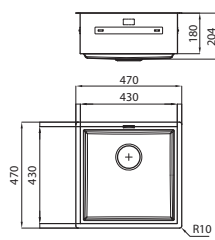

SINKS

Drawing of position of accessories on steps

Grids, chopping boards, tool holders, trays and containers of various sizes can be moved around the work area with a simple gesture and can be stacked so that they are always within reach.

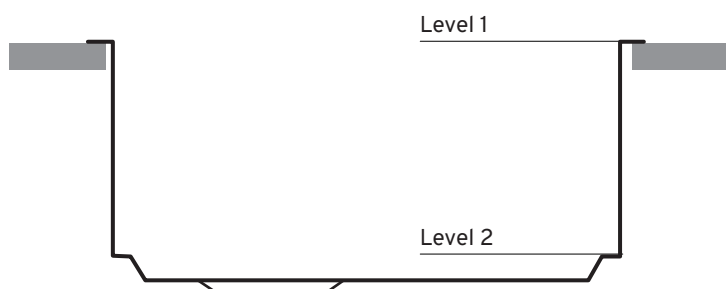

Quadra R12 NEW
top-mount | flush-mount





Sinks with bowls R12



The bottom is diamond-shaped



A Black grid is included that can be placed either on the worktop or on the bottom (it is fitted with 4 rubber pads)





Quadra R12 Sinks NEW

top-mount | flush-mount

Code	Version	Characteristics	Price
------	---------	-----------------	-------

Cabinet 80



1737 050	 FT	FT cut-out: see website	
	 SPT	SPT cut-out: 770 x 510	



- Satin finish AISI 304 stainless steel
- Dimensions: **780 x 520** - 1 bowl: **740 x 400**
- 3½" PM automatic waste fitting
- Additional holes available

Included: **1 grid** (8100 617)
 Accessories, technical drawing and automatic waste fittings on page 124



Cabinet 60



1735 050	 FT	FT cut-out: see website	
	 SPT	SPT cut-out: 530 x 510	

- Satin finish AISI 304 stainless steel
- Dimensions: **540 x 520** - 1 bowl: **500 x 400**
- 3½" PM automatic waste fitting
- Additional holes available

Included: **1 grid** (8100 617)
 Accessories, technical drawing and automatic waste fittings on page 124



Quadra R12 Bowls

top-mount | flush-mount



Code	Version	Characteristics	Price
------	---------	-----------------	-------

Cabinet 90



1718 050	FT	FT cut-out: see website*
	SPT	SPT cut-out: 820 x 430*

- Satin finish AISI 304 stainless steel
- Dimensions: **840 x 440** - 1 bowl: **800 x 400**
- 3½" waste fitting
- *The hole requires a cut-out to house the overflow (only for worktops >30)

Included: **1 grid** (8100 617)
Accessories, technical drawing and automatic waste fittings on page 124

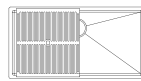

Configuration of Black grids flush with bowl

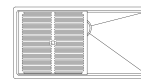

Configuration of Black grids at bottom of bowl

Cabinet 80



1717 050	FT	FT cut-out: see website*
	SPT	SPT cut-out: 730 x 430*

- Satin finish AISI 304 stainless steel
- Dimensions: **750 x 440** - 1 bowl: **710 x 400**
- 3½" waste fitting
- *The hole requires a cut-out to house the overflow (only for worktops >30)

• Also available in version **PVD**

Gun Metal
1717 056

GM Fumè
1717 016

Brandy
1715 055

Brandy Fumè
1715 015



page 28



page 28



page 28



page 28

Included: **1 grid** (8100 617)
Accessories, technical drawing and automatic waste fittings on page 124

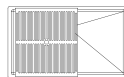

Configuration of Black grids flush with bowl

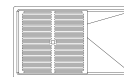

Configuration of Black grids at bottom of bowl

Cabinet 60



1715 050	FT	FT cut-out: see website*
	SPT	SPT cut-out: 520 x 430*

- Satin finish AISI 304 stainless steel
- Dimensions: **540 x 440** - 1 bowl: **500 x 400**
- 3½" waste fitting
- *The hole requires a cut-out to house the overflow (only for worktops >30)

• Also available in version **PVD**

Gun Metal
1715 056

GM Fumè
1715 016

Brandy
1715 055

Brandy Fumè
1715 015



page 28



page 28



page 83



page 83

Included: **1 grid** (8100 617)
Accessories, technical drawing and automatic waste fittings on page 124



Configuration of Black grids flush with bowl



Configuration of Black grids at bottom of bowl

Quadra R12 Sinks and Bowls NEW

accessories

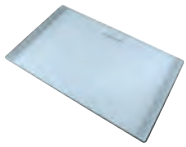

L4

Glass chopping board 23x41 cm
8631 300



N2

HDPE chopping board 27.2x42.5 cm
8657 001



N3

HDPE Twin chopping board 31.7x42.5 cm
8644 101



K7

Iroko wood chopping board kit 42 x 31.7 cm with stainless steel colander
8644 044



K8 *

Graters kit with frame and food collection tray
8159 101



R2

Stainless steel basket 34x40 cm
8611 000



O2

White bowl 41.4x27.2 cm
8153 100



T1

Stainless steel plate rack 25x42.5 cm
8100 201



T2 *

Stainless steel plate rack 21.4x37.9 cm
8100 303



Z2 *

Stainless steel perforated tray 21.5x38 cm
8151 000

Also available in version **PVD**



Gun Metal
8151 006



Copper
8151 008



Gold
8151 009

1737 050 **L4 N2 N3 K7 K8 R2 O2 T1**
T2 Z2

1735 050 **L4 N2 N3 K7 K8 R2 O2 T1**
T2 Z2

1718 050 **L4 N2 N3 K7 K8 R2 O2 T1**
T2 Z2

1717 050 **L4 N2 N3 K7 K8 R2 O2 T1**
T2 Z2

1715 050 **L4 N2 N3 K7 K8 R2 O2 T1**
T2 Z2

optional automatic waste fittings

1737 050 **PL PP PA PE PM**

1735 050 **PL PP PA PE PM**

1718 050 **PL PP PA PE PM**

1717 050 **PL PP PA PE PM**

1715 050 **PL PP PA PE PM**

Vedi pag. 298

* only usable in combination with chopping board N3

Quadra R12 Sinks **NEW** | technical drawings

1737 050

1735 050

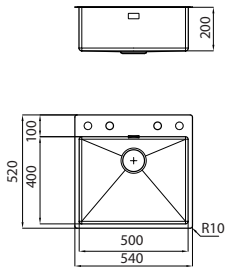
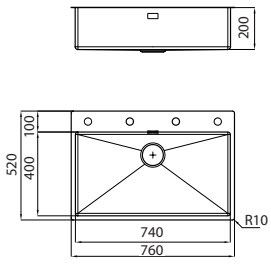

Quadra R12 Bowls **NEW** | technical drawings

1718 050

1717 050

1715 050

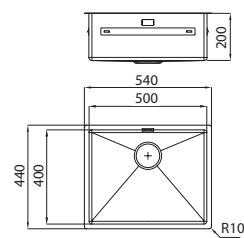
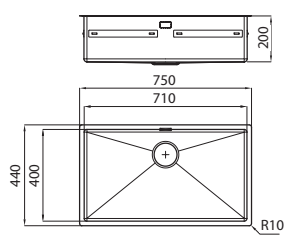
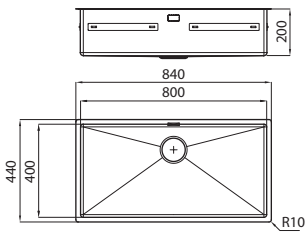

SINKS

Quadra

top-mount | flush-mount | flat edge

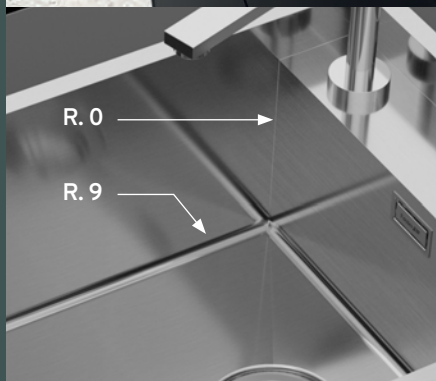



The R9 radius
on the bottom facilitates
cleaning operations

Quadra

top-mount | flush-mount

Code	Version	Characteristics	Price
------	---------	-----------------	-------

Cabinet 80

1237 050	 FT	FT cut-out: see website	
	 SPT	SPT cut-out: 730 x 420	



- Satin finish AISI 304 stainless steel
- Dimensions: **750 x 440** - 1 bowl: **630 x 400**
- 3½" PM automatic waste fitting
- Additional holes available

Accessories and technical drawing on page 130

SINKS

Cabinet 60

1235 050	 FT	FT cut-out: see website	
	 SPT	SPT cut-out: 520 x 420	





- Satin finish AISI 304 stainless steel
- Dimensions: **540 x 440** - 1 bowl: **420 x 400**
- 3½" PM automatic waste fitting
- Additional holes available

Accessories and technical drawing on page 130

The sink can be installed with the tap counter on the back or side

Cabinet 60

1236 050	 FT	FT cut-out: see website	
	 SPT	SPT cut-out: 420 x 420	



- Satin finish AISI 304 stainless steel
- Dimensions: **440 x 440** - 1 bowl: **320 x 400**
- 3½" PM automatic waste fitting
- Additional holes available

Accessories and technical drawing on page 130

The sink can be installed with the tap counter on the back or side

Quadra



top-mount | flush-mount | flat edge

Cabinet (80)⁹/120 (see page 16)



Accessories, technical drawing and automatic waste fittings on page 130

Code	Version	Characteristics	Price
------	---------	-----------------	-------



1220 050	 FT	FT cut-out: see website	
	 SPT	SPT cut-out: 987 x 427	

- Satin finish AISI 304 stainless steel
- Dimensions: **1000 x 440** - 1 bowl: **675 x 400**
- 3½" waste fitting

Cabinet 90



Accessories, technical drawing and automatic waste fittings on page 130



1218 050	 FT	FT cut-out: see website	
	 SPT	SPT cut-out: 847 x 447	

- Satin finish AISI 304 stainless steel
- Dimensions: **864 x 464** - 1 bowl: **800 x 400**
- 3½" waste fitting

Cabinet 90



Accessories and technical drawing on page 130

1219 050	 SF	SF cut-out: 820 x 495	
1229 050	 FT	FT cut-out: see website	
	 SPT	SPT cut-out: 808 x 486	

- Satin finish AISI 304 stainless steel
- **SF** Dimensions: **840 x 510** - 1 bowl: **761 x 400**
- **FT** and **SPT** Dimensions: **825 x 503** - 1 bowl: **761 x 400**
- 3½" PM automatic waste fitting
- Additional holes available



Quadra

top-mount | flush-mount | flat edge

Cabinet 90 **NEW**



Accessories, technical drawing and automatic waste fittings on page 130

Code	Version	Characteristics	Price
1221 050	 FT	FT cut-out: see website*	
	 SPT	SPT cut-out: 820 x 420*	



- Satin finish AISI 304 stainless steel
- Dimensions: **840 x 440** - 2 bowls: **380 x 400**
- 3½" waste fitting

* The built-in cut-out requires a recess to house the overflow (see website)

Cabinet 60



Accessories, technical drawing and automatic waste fittings on page 130

1215 050	 FT	FT cut-out: see website
	 SPT	SPT cut-out: 547 x 447

- Satin finish AISI 304 stainless steel
- Dimensions: **564 x 464** - 1 bowl: **500 x 400**
- 3½" waste fitting

Cabinet 45



Accessories and technical drawing on page 130

1205 050	 SF	SF cut-out: 459 x 495
----------	---	-----------------------

- Satin finish AISI 304 stainless steel
- Dimensions: **479 x 510** - 1 bowl: **400 x 400**
- 3½" PM automatic waste fitting

Quadra

accessories



B3
Black grid
39 x 42 cm
8100 617

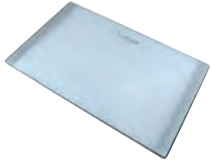

L4
Glass chopping
board 23x41 cm
8631 300



N2
HDPE chopping
board 27.2x42.5 cm
8657 001



N3
HDPE Twin chop-
ping board
31.7x42.5
8644 101



O2
White bowl
27.2x41.4 cm
8153 100



K7
Iroko wood chopping
board kit 42 x 31.7 cm
with
stainless steel
colander
8644 044



K8 *
Graters kit with frame
and food tray
8159 101



R2
Stainless steel basket
34x40 cm
8611 000



R3
Stainless steel basket
40x40
8612 000

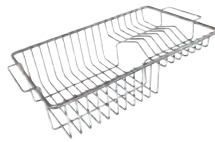

T1
Stainless steel
plate rack
25x42.5 cm
8100 201

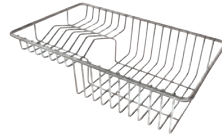

T2 *
Stainless steel
plate rack
21.4x37.9 cm
8100 303



Z2 *
Stainless steel
perforated tray
21.5x38 cm
8151 000

Also available in version **PVD**



Gun Metal
8151 006



Copper
8151 008



Gold
8151 009

1237 050 **B3 L4 N2 N3 O2 K7 K8 R2**
R3 T T2 Z2

1235 050 **B3 L4 N2 N3 O2 K7 K8 R2**
R3 T T2 Z2

1236 050 **B3 L4 N2 N3 O2 K7 K8 R2**
R3 T T2 Z2

1220 050 **B3 L4 N2 N3 O2 K7 K8 R2**
R3 T T2 Z2

1218 050 **B3 L4 N2 N3 O2 K7 K8 R2**
R3 T T2 Z2

1219 050 **B3 L4 N2 N3 O2 K7 K8 R2**
1229 050 **R3 T T2 Z2**

1221 050 **B3 L4 N2 N3 O2 K7 K8 R2**
R3 T T2 Z2

1215 050 **B3 L4 N2 N3 O2 K7 K8 R2**
T2 T T2 Z2

optional automatic waste fittings

1221 050 **PL PA PM PP**

1220 050 **PL PB PA PM**

1218 050 **PL PB PA PM**

1215 050 **PL PB PA PM**

Vedi pag. 298

* only usable in combination with chopping board N3

1237 050

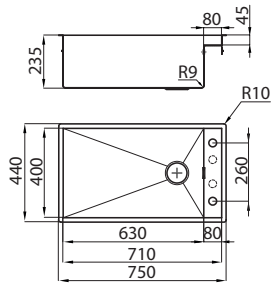

1235 050

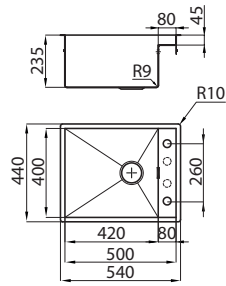

1236 050

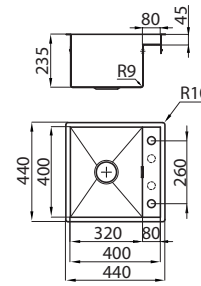

1220 050

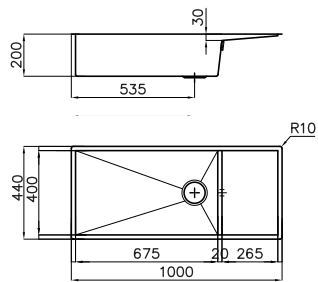

1218 050

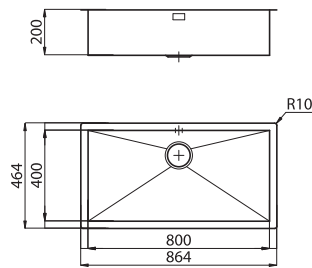

1219 050

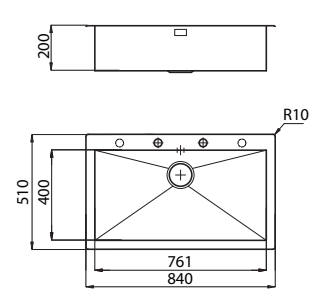

1221 050

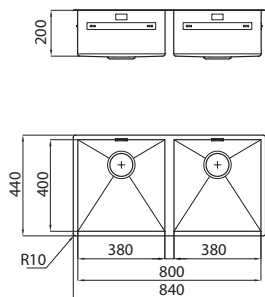

1215 050

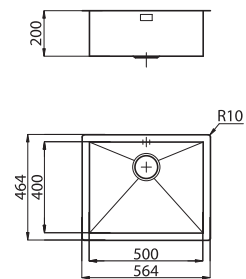

1205 050

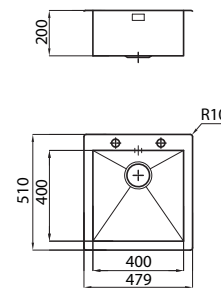

1229 050

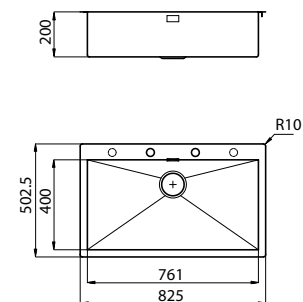

Circolari NEW

top-mount | flush-mount

Thick sink

Impressive concentric polishing



Cabinet 45



Code	Version	Characteristics	Price
------	---------	-----------------	-------

1130 060

Version

FT

Characteristics

FT cut-out: see website*

SPT

SPT cut-out: Ø 410*

- Satin finish AISI 304 stainless steel
- Dimensions: Ø 425 - 1 bowl: Ø 380
- 3/2" waste fitting
- *The built-in hole requires a cut-out to house the overflow

• Also available in version **PVD**

Gun Metal
1130 066



page 29

Copper
1130 068



page 52

Gold
1130 069



page 70

accessories



P1

Chopping board
41.4 x 32 cm
in Iroko wood
8648 002

optional automatic waste fittings

PR PQ PC

See page 298

technical drawing

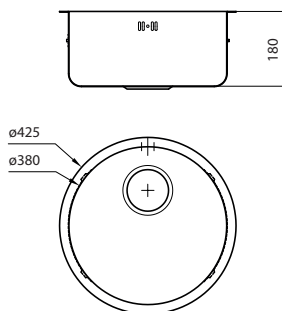



S4001 sinks



top-mount | flush-mount



Cabinet 90 **NEW**



Accessories and technical drawing on page 140

Code	Version	Characteristics	Price
3367 050	 FT	FT cut-out: see website	
	 SPT	SPT cut-out: 848 x 508	

- Satin finish AISI 304 stainless steel
- Dimensions: **860 x 520** - 1 bowl: **800 x 400**
- Space 3½" PA automatic waste fitting
- Additional holes available



S4001 sinks

top-mount | flush-mount

Code	Version	Characteristics	Price
------	---------	-----------------	-------

Cabinet 80



3366 050	 FT	FT cut-out: see website
	 SPT	SPT cut-out: 758 x 508



- Satin finish AISI 304 stainless steel
- Dimensions: **770 x 520** - 1 bowl: **710 x 400**
- Space 3½" PA automatic waste fitting
- Additional holes available

Accessories and technical drawing on page 140

SINKS

Cabinet 60





3365 050	 FT	FT cut-out: see website
	 SPT	SPT cut-out: 548 x 508

- Satin finish AISI 304 stainless steel
- Dimensions: **560 x 520** - 1 bowl: **500 x 400**
- Space 3½" PA automatic waste fitting
- Additional holes available

Accessories and technical drawing on page 140

Cabinet 45



3363 050	 FT	FT cut-out: see website
	 SPT	SPT cut-out: 448 x 508

- Satin finish AISI 304 stainless steel
- Dimensions: **460 x 520** - 1 bowl: **400 x 400**
- Space 3½" PA automatic waste fitting
- Additional holes available

Accessories and technical drawing on page 140

S4001 bowls R12
top-mount | flush-mount



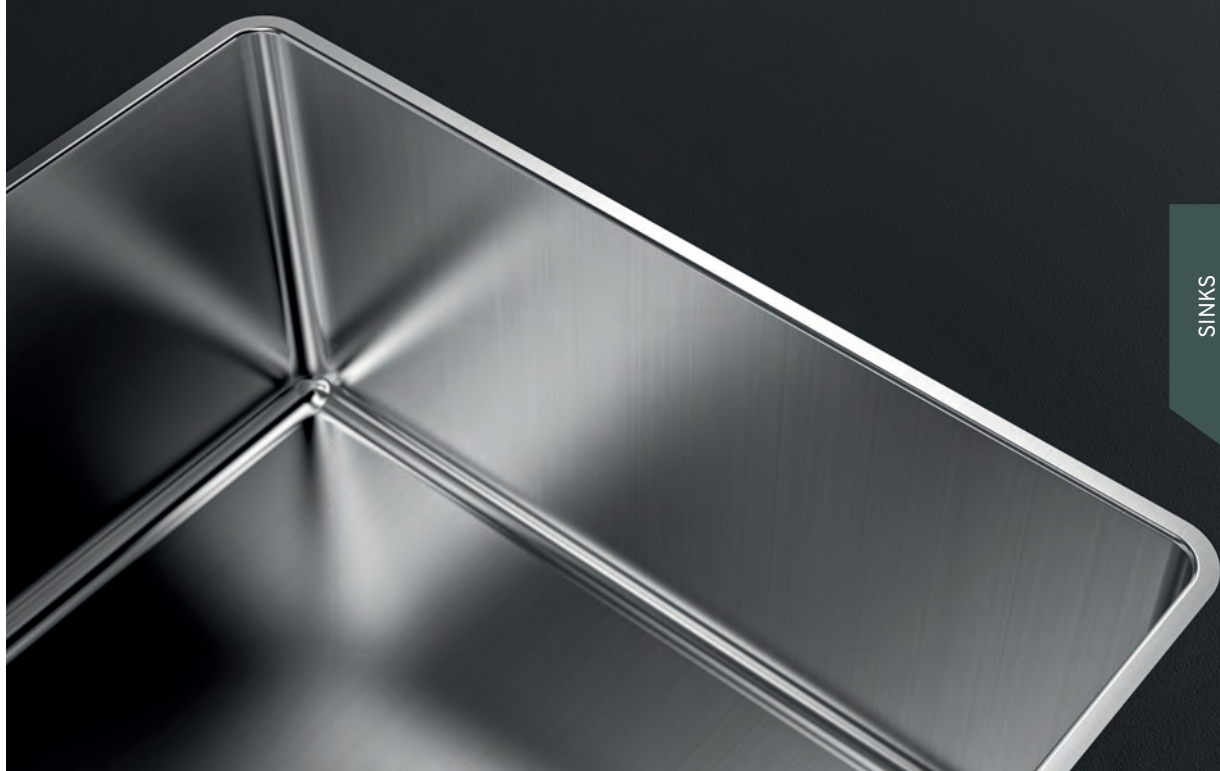

Sinks with bowls R12

S4001 bowls R12

top-mount | flush-mount

Code	Version	Characteristics	Price
------	---------	-----------------	-------

Cabinet 90



3358 050	 FT	FT cut-out: see website*
	 SPT	SPT cut-out: 820 x 430*

- Satin finish AISI 304 stainless steel
- Dimensions: **840 x 440** - 1 bowl: **800 x 400**
- Space 3½" waste fitting

* The built-in cut-out requires a recess to house the overflow (only for worktops > 30)

Accessories, technical drawing and automatic waste fittings on page 140

Cabinet 80



3357 050	 FT	FT cut-out: see website*
	 SPT	SPT cut-out: 730 x 430*

- Satin finish AISI 304 stainless steel
- Dimensions: **750 x 440** - 1 bowl: **710 x 400**
- Space 3½" waste fitting

* The built-in cut-out requires a recess to house the overflow (only for worktops > 30)

Accessories, technical drawing and automatic waste fittings on page 140

Cabinet 80



3352 050	 FT	FT cut-out: see website*
	 SPT	SPT cut-out: 730 x 430*

- Satin finish AISI 304 stainless steel
- Dimensions: **750 x 440** - 2 bowls: **340 x 400**
- Space 3½" waste fitting

* The built-in cut-out requires a recess to house the overflow (only for worktops > 30)

Accessories, technical drawing and automatic waste fittings on page 140



S4001 bowls R12

top-mount | flush-mount

Cabinet 60



Accessories, technical drawing and automatic waste fittings on page 140

Code	Version	Characteristics	Price
3355 050	 FT	FT cut-out: see website*	
	 SPT	SPT cut-out: 520 x 430*	

- Satin finish AISI 304 stainless steel
- Dimensions: **540 x 440** - 1 bowl: **500 x 400**
- Space 3½" waste fitting

* The built-in cut-out requires a recess to house the overflow (only for worktops > 30)

SINKS

Cabinet 45



Accessories, technical drawing and automatic waste fittings on page 140

3356 050	 FT	FT cut-out: see website*
	 SPT	SPT cut-out: 420 x 430*



- Satin finish AISI 304 stainless steel
- Dimensions: **440 x 440** - 1 bowl: **400 x 400**
- Space 3½" waste fitting

* The built-in cut-out requires a recess to house the overflow (only for worktops > 30)

Cabinet 40



Accessories, technical drawing and automatic waste fittings on page 140

3353 050	 FT	FT cut-out: see website*
	 SPT	SPT cut-out: 360 x 430*

- Satin finish AISI 304 stainless steel
- Dimensions: **380 x 440** - 1 bowl: **340 x 400**
- Space 3½" waste fitting

* The built-in cut-out requires a recess to house the overflow (only for worktops > 30)

S4001 sinks and bowls

accessories



B3
Black grid
39 x 42 cm
8100 617

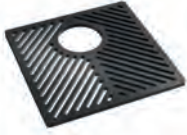

B6
Black grid
38 x 38 cm
8100 651



B7
Black grid
38 x 48 cm
8100 652



B8
Black grid
38 x 69 cm
8100 653



K7
Iroko wood chop-
ping board kit 42 x
31.7 cm
with stainless steel
colander
8644 044

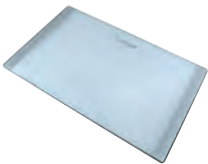

L4
Glass chopping
board 23x41 cm
8631 300



N2
HDPE chopping
board 27.2x42.5 cm
8657 001



N3
HDPE Twin chop-
ping board
31.7x42.5
8644 101



O2
White bowl
27.2x41.4 cm
8153 100



K8 *
Graters kit with frame
and food tray
8159 101



R2
Stainless steel basket
34x40 cm
8611 000



R3
Stainless steel
basket 40x40
8612 000

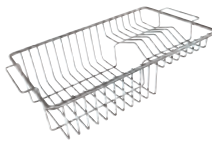

T1
Stainless steel
plate rack
25x42.5 cm
8100 201

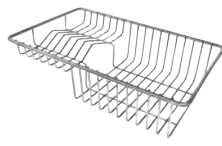

T2 *
Stainless steel
plate rack
21.4x37.9 cm
8100 303



Z2 *
Stainless steel
perforated tray
21.5x38 cm
8151 000

Also available in version PVD



3367 050 **B3 K7 L4 N2 N3 O2 K8 R2**
R3 T1 T2 Z2

3366 050 **B3 K7 L4 N2 N3 O2 K8 R2**
R3 T1 T2 Z2

3365 050 **B3 K7 L4 N2 N3 O2 K8 R2**
R3 T1 T2 Z2

3363 050 **K7 L4 N2 N3 O2 K8 R2 R3**
T1 T2 Z2

3358 050 **B3 K7 L4 N2 N3 O2 K8 R2**
R3 T1 T2 Z2

3357 050 **B3 B8 K7 L4 N2 N3 O2 K8**
R2 R3 T1 T2 Z2

3352 050 **K7 L4 N2 N3 O2 K8 R2 R3**
T1 T2 Z2

3355 050 **B3 B7 K7 L4 N2 N3 O2 K8**
R2 R3 T1 T2 Z2

3356 050 **B3 B6 K7 L4 N2 N3 O2 K8**
R2 R3 T1 T2 Z2

3353 050 **K7 L4 N2 N3 O2 K8 R2 R3**
T1 T2 Z2

optional automatic waste fittings

3358 050 **PA PE PM PL PP**

3357 050 **PA PE PM PL PP**

3352 050 **PA PE PM PL PP**

3355 050 **PA PE PM PL PP**

3356 050 **PA PE PM PL PP**

3353 050 **PA PE PM PL PP**

Vedi pag. 298

* only usable in combination with chopping board N3

S4001 | sinks

technical drawings

3367 050

NEW

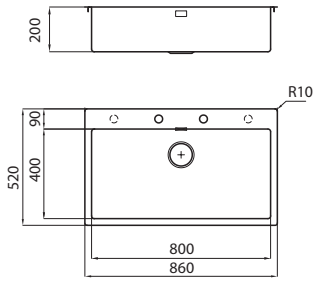

3366 050

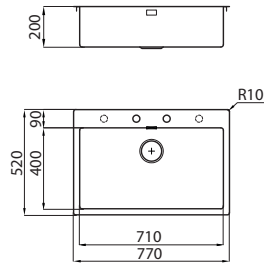

3365 050

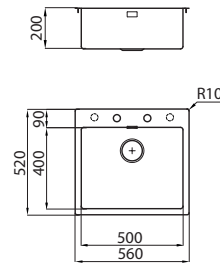

3363 050

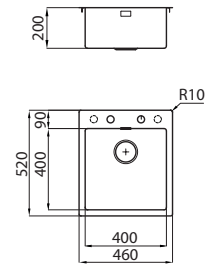

S4001 | bowls R12

technical drawings

3358 050

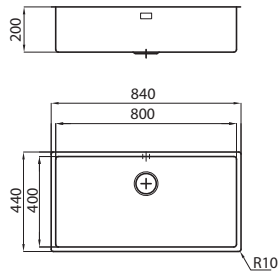

3357 050

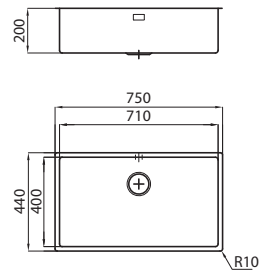

3352 050

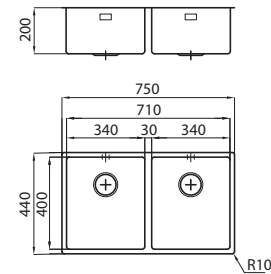

3355 050

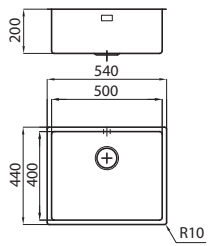

3356 050

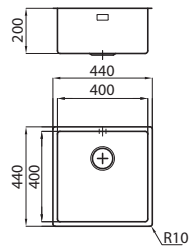

3353 050

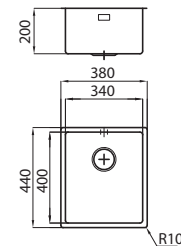

New Wave

top-mount | flush-mount



reddot design award
winner 2015



Distinctive design

of the drainer with its refined wide radius of connection.

New Wave

top-mount | flush-mount



Code

Version

Characteristics

Price

Cabinet 80

1416 001 rh	 FT	FT cut-out: see website
1416 002 lh	 SPT	SPT cut-out: 1148 x 508





- Satin finish AISI 304 stainless steel
- Dimensions: **1160 x 520** - 1 bowl: **710 x 400**
- Space 3.5" PA automatic waste fitting

Accessories and technical drawing on page 144

Left version pictured

Cabinet 80



1412 000	 FT	FT cut-out: see website
	 SPT	SPT cut-out: 798 x 508



- Satin finish AISI 304 stainless steel
- Dimensions: **810 x 520** - 1 bowl: **710 x 400**
- Space 3.5" PA automatic waste fitting

Accessories and technical drawing on page 144

Cabinet 60

1410 000	 FT	FT cut-out: see website
	 SPT	SPT cut-out: 588 x 508



- Satin finish AISI 304 stainless steel
- Dimensions: **600 x 520** - 1 bowl: **500 x 400**
- Space 3.5" PA automatic waste fitting

Accessories and technical drawing on page 144

SINKS

New Wave | accessories

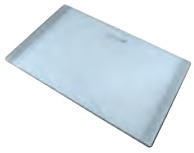

L4

Glass chopping board
23 x 41 cm
8631 300



N2

HDPE chopping board
27.2 x 42.5 cm
8657 001



N3

HDPE Twin
chopping board
31.7 x 42.5 cm
8644 101



O2

White bowl
27.2 x 41.4 cm
8153 100



K8 *

Graters kit
with frame and food
collection tray
8159 101



R3

Stainless steel basket
40 x 40 cm
8612 000



T1

Plate rack
25 x 42.5 cm
8100 201



T2 *

Stainless steel plate
rack 21.4 x 37.9 cm
8100 303



Z2 *

Stainless steel perforated tray
21.5 x 38 cm
8151 000



B3

Black grid
39 x 42 cm
8100 617

1416 001 L4 N2 N3 O2 K8 R3 T1 T2
1416 002 Z2 B3

1412 000 L4 N2 N3 O2 K8 R3 T1 T2

Z2 B3

1410 000 L4 N2 N3 O2 K8 R3 T1 T2

Z2 B3

Also available in version PVD



Gun Metal
8151 006



Copper
8151 008



Gold
8151 009

* only usable in combination with chopping board N3

1416 001 rh | 1416 002 lh

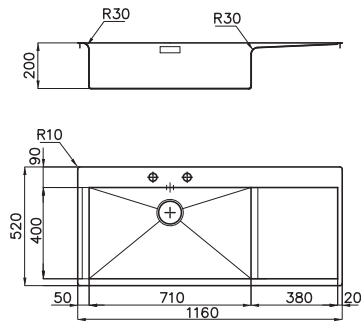

1412 000

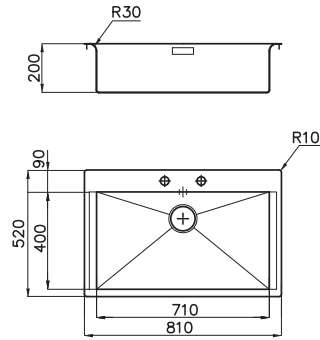

1410 000

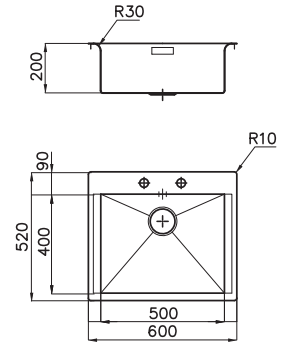

Fortyfour
standard





Perfect combination

perfectly matched

with the Veronika 3 burners hob and with the S1000 3 zones induction hob.

Cabinet 45

Code	Version	Characteristics	Price
4151 050	 STD	cut-out: 420 x 480	



- Satin finish AISI 304 stainless steel
- Dimensions: **440 x 500** - 1 bowl: **365 x 350**
- 3½" waste fitting
- Additional holes available

accessories



P3
Chopping board
26 x 36.6 cm
8643 117



T6
Plate rack
stainless steel
23 x 37.5
8100 305

optional automatic waste fittings

PA PE PM PL PP

See page 298

technical drawing

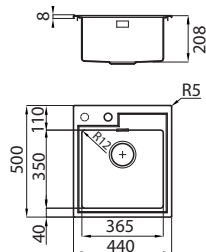

perfect combination



Fortyfour is a sink designed for small spaces that require aesthetics and functionality. The utmost freedom of combination: Fortyfour is perfectly matched with the Veronika 3 burners hob and with the S1000 3 zones induction hob.

Master
top-mount | flush-mount



Master

top-mount | flush-mount

Code	Version	Characteristics	Price
------	---------	-----------------	-------

Cabinet 80

1252 051 rh	FT	FT cut-out: see website	
1252 052 lh	SPT	SPT cut-out: 1147 x 507	



- Satin finish AISI 304 stainless steel
- Dimensions: **1160 x 520** - 2 bowls: **340 x 400**
- 3½" PM automatic waste fitting
- Additional holes available

Accessories and technical drawing on page 150

SINKS

Cabinet 60

1251 051 rh	FT	FT cut-out: see website	
1251 052 lh	SPT	SPT cut-out: 987 x 507	



- Satin finish AISI 304 stainless steel
- Dimensions: **1000 x 520** - 2 bowls: **340 x 400 + 180 x 400**
- 3½" PM automatic waste fitting
- Additional holes available

Accessories and technical drawing on page 150

Cabinet 60

1250 051 rh	FT	FT cut-out: see website	
1250 052 lh	SPT	SPT cut-out: 847 x 507	



- Satin finish AISI 304 stainless steel
- Dimensions: **860 x 520** - 1 bowl: **450 x 400**
- 3½" PM automatic waste fitting
- Additional holes available

Accessories and technical drawing on page 150

Master

accessories

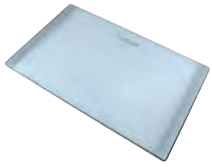

L4
Glass chopping board 23x41 cm
8631 300



N2
HDPE chopping board 27.2x42.5 cm
8657 001



N3
HDPE Twin chopping board 31.7x42.5
8644 101



O2
White bowl 27.2x41.4 cm
8153 100



K7
Iroko wood chopping board kit 42 x 31.7 cm with stainless steel colander
8644 044



K8 *
Graters kit with frame and food tray
8159 101



R2
Stainless steel basket 34x40 cm
8611 000



R3
Stainless steel basket 40x40 - 8612 000



T1
Stainless steel plate rack 25x42.5 cm
8100 201



T2 *
Stainless steel plate rack 21.4x37.9 cm
8100 303



Z2 *
Stainless steel perforated tray 21.5x38 cm
8151 000

Also available in version PVD



Gun Metal
8151 006



Copper
8151 008



Gold
8151 009

1252 051 L4 N2 N3 O2 K7 K8 R2 R3
1252 052 T1 T2 T2

1251 051 L4 N2 N3 O2 K7 K8 R2 R3
1251 052 T1 T2 T2

1250 051 L4 N2 N3 O2 K7 K8 R2 R3
1250 052 T1 T2 T2

* only usable in combination with chopping board N3

1252 051 rh | 1252 052 lh

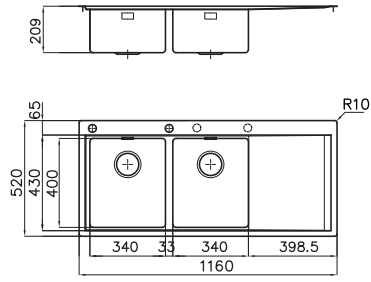

1251 051 rh | 1251 052 lh

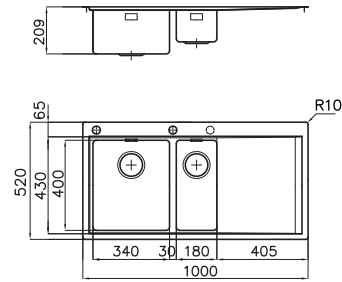

1250 051 rh | 1250 052 lh

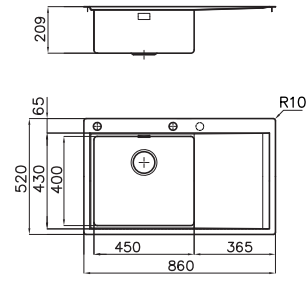

FL

top-mount | flush-mount | standard



Perfect
combination



perfectly
matched

with the
FL 5 burners hob



Cabinet 80



Code	Version	Characteristics	Price
2975 060	 STD	STD cut-out: 840 x 480	
2977 060	 FT	FT cut-out: see website	
	 SPT	SPT cut-out: 860 x 500	

- Satin finish AISI 304 stainless steel
- Dimensions: **STD 860 x 500** - 1 bowl: **720 x 320**
- Dimensions: **FT/SPT 873 x 513** - 1 bowl: **720 x 320**
- Space 3½" waste fitting
- Additional holes available

technical drawings

2977 060

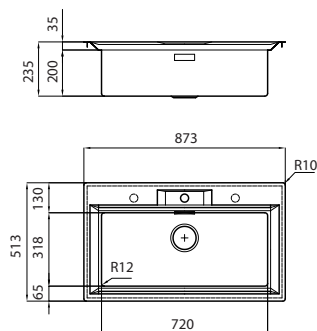

2975 060

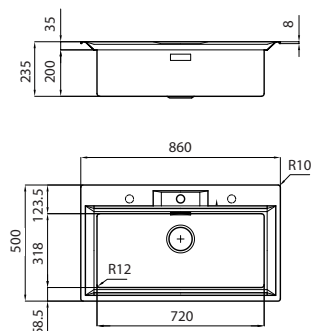

accessories



T5

Stainless steel
plate rack 21.4 x 33.1
8100 304

KE
flat edge



KE

flat edge

Code

Version

Characteristics

Price

Cabinet 90

2211 051 rh
2211 052 rh



cut-out: 1140 x 480



- Satin finish AISI 304 stainless steel
- Dimensions: **1173 x 513** - 1 bowl: **710 x 400**
- 3/2" waste fitting
- Additional holes available

Accessories, technical drawing and automatic waste fittings on page 162

Cabinet 90

2222 051 rh
2222 052 rh



cut-out: 1140 x 480



- Satin finish AISI 304 stainless steel
- Dimensions: **1173 x 513** - 2 bowls: **340 x 400**
- 3/2" waste fitting
- Additional holes available

Accessories, technical drawing and automatic waste fittings on page 162

Cabinet 60

2263 051 rh
2263 052 rh



cut-out: 950 x 480



- Satin finish AISI 304 stainless steel
- Dimensions: **983 x 513** - 1 bowl: **500 x 400**
- 3/2" waste fitting
- Additional holes available

Accessories, technical drawing and automatic waste fittings on page 162

KE

flat edge

Code

Version

Characteristics

Price

■ Cabinet 60/(80)^T (see page 16)

2297 051 rh
2297 052 rh



cut-out: 950 x 480



- Satin finish AISI 304 stainless steel
- Dimensions: **983 x 513** - 2 bowls: **180 x 340 + 340 x 400**
- 3½" waste fitting
- Additional holes available

Accessories, technical drawing and automatic waste fittings on page 162

■ Cabinet 90

2287 050



cut-out: 840 x 480



- Satin finish AISI 304 stainless steel
- Dimensions: **873 x 513** - 1 bowl: **710 x 400**
- 3½" waste fitting
- Additional holes available

Accessories, technical drawing and automatic waste fittings on page 162

■ Cabinet 90

2283 050



cut-out: 840 x 480



- Satin finish AISI 304 stainless steel
- Dimensions: **873 x 513** - 2 bowls: **340 x 400**
- 3½" waste fitting

Accessories and technical drawing on page 162

KE

flat edge

Cabinet 90



Accessories, technical drawing and automatic waste fittings on page 162

Code	Version	Characteristics	Price
------	---------	-----------------	-------

2280 051 rh
2280 052 rh



cut-out: 840 x 480

- Satin finish AISI 304 stainless steel
- Dimensions: **873 x 513** - 1 bowl: **450 x 400**
- 3½" waste fitting
- Additional holes available

KE



top-mount | flush-mount | Q4



Cabinet 80



Accessories and technical drawing on page 162

Code	Version	Characteristics	Price
2278 050	 Q4	cut-out: 750 x 500	
2266 050	 FT	FT cut-out: see website	
	 SPT	SPT cut-out: 758 x 508	

- Satin finish AISI 304 stainless steel
- Dimensions: **770 x 520** - 1 bowl: **710 x 400**
- 3½" PM automatic waste fitting
- Additional holes available

• Also available in version

Vintage
FT - SPT
2266 080





KE

top-mount | flush-mount | Q4

Cabinet 80



Accessories and technical drawing on page 162

Code	Version	Characteristics	Price
2279 050	 Q4	cut-out: 750 x 500	
2269 050	 FT  SPT	FT cut-out: see website SPT cut-out: 758 x 508	

- Satin finish AISI 304 stainless steel
- Dimensions: **770 x 520** - 2 bowls: **340 x 400**
- 3½" PM automatic waste fitting
- Additional holes available

• Also available in version



Vintage
FT - SPT
2269 080



Cabinet 60



Accessories and technical drawing on page 162

2272 050	 Q4	cut-out: 540 x 500
2265 050	 FT  SPT	FT cut-out: see website SPT cut-out: 548 x 508

- Satin finish AISI 304 stainless steel
- Dimensions: **560 x 520** - 1 bowl: **500 x 400**
- 3½" PM automatic waste fitting

• Also available in version



Vintage
FT - SPT
2265 080



Cabinet 60



Accessories and technical drawing on page 162

2274 050	 Q4	cut-out: 490 x 500
2264 050	 FT  SPT	FT cut-out: see website SPT cut-out: 498 x 508

- Satin finish AISI 304 stainless steel
- Dimensions: **510 x 520** - 1 bowl: **450 x 400**
- 3½" PM automatic waste fitting

• Also available in version

Vintage
FT - SPT
2264 080



KE bowls R15



top-mount | flush-mount



Cabinet 80



Accessories, technical drawing and automatic waste fittings on page 162

Code	Version	Characteristics	Price
2157 050	 FT	FT cut-out: see website*	
	 SPT	SPT cut-out: 730 x 420*	

- Satin finish AISI 304 stainless steel
- Dimensions: **750 x 440** - 1 bowl: **710 x 400**
- 3½" waste fitting

* The built-in cut-out requires a recess to house the overflow (see website)

• Also available in version **Vintage, PVD** and **PVD Vintage**

Vintage inox 2157 080	Gun Metal 2157 056	Copper 2157 058	Gold 2157 059	Brandy 2157 055
---------------------------------	------------------------------	---------------------------	-------------------------	---------------------------



page 30



page 50



page 68



page 84

NEW

KE bowls R15

top-mount | flush-mount

Cabinet 60



Accessories, technical drawing and automatic waste fittings on page 162

Code	Version	Characteristics	Price
------	---------	-----------------	-------

2155 050	FT	FT cut-out: see website*	
	SPT	SPT cut-out: 520 x 420*	

- Satin finish AISI 304 stainless steel
- Dimensions: **540 x 440** - 1 bowl: **500 x 400**
- 3½" waste fitting

* The built-in cut-out requires a recess to house the overflow (see website)

• Also available in version **Vintage, PVD** and **PVD Vintage**

Vintage inox	Gun Metal	Copper	Gold	Brandy
2155 080	2157 856	2155 058	2155 059	2155 055
				NEW
Vintage 2155 086				
page 30	page 50	page 68	page 85	

Cabinet 60



Accessories, technical drawing and automatic waste fittings on page 162

2154 050	FT	FT cut-out: see website*
	SPT	SPT cut-out: 470 x 420*

- Satin finish AISI 304 stainless steel
- Dimensions: **490 x 440** - 1 bowl: **450 x 400**
- 3½" waste fitting

* The built-in cut-out requires a recess to house the overflow (see website)

• Also available in version **PVD**

Gun Metal
2154 056
page 31

Cabinet 45



Accessories, technical drawing and automatic waste fittings on page 162

2156 050	FT	FT cut-out: see website*
	SPT	SPT cut-out: 420 x 420*

- Satin finish AISI 304 stainless steel
- Dimensions: **440 x 440** - 1 bowl: **400 x 400**
- 3½" waste fitting

* The built-in cut-out requires a recess to house the overflow (see website)

• Also available in version **Vintage, PVD** and **PVD Vintage**

Vintage inox	Gun Metal
2156 080	2156 056
Vintage 2156 086	
page 32	

B3
Black grid
39 x 42 cm
8100 617

B6
Black grid
38 x 38 cm
8100 651

B7
Black grid
38 x 48 cm
8100 652

B8
Black grid
38 x 69 cm
8100 653

L4
Glass chopping board
23x41 cm
8631 300

N2
HDPE chopping board
27.2x42.5 cm
8657 001

N3
HDPE Twin chopping board
31.7x42.5 cm
8644 101

O2
White bowl
27.2x41.4 cm
8153 100

K7
Iroko wood chopping board kit 42 x 31.7 cm with stainless steel colander
8644 044

K8 *
Graters kit with frame and food tray
8159 101

R2
Stainless steel basket 34x40 cm
8611 000

R3
Stainless steel basket 40x40
8612 000

T1
Stainless steel plate rack 25x42.5 cm
8100 201

T2 *
Stainless steel plate rack 21.4x37.9 cm
8100 303

Z2 *
Stainless steel perforated tray 21.5x38 cm
8151 000

Also available in version PVD

Gun Metal 8151 006 | **Copper** 8151 008 | **Gold** 8151 009

* only usable in combination with chopping board N3

optional automatic waste fittings

2211 051 PA PE PM PL PP
2211 052

2222 051 PA PE PM PL PP
2222 052

2263 051 PA PE PM PL PP
2263 052

2297 051 PA PE PM PL PP
2297 052

2287 050 PA PE PM PL PP

2280 051 PA PE PM PL PP
2280 052

2157 050 PA PE PM PL PP

2155 050 PA PE PM PL PP

2154 050 PA PE PM PL PP

2156 050 PA PE PM PL PP

2211 051 B8 L4 N2 N3 B3 O2 K7 K8
2211 052 R2 R3 T1 T2 Z2

2222 051 L4 N2 N3 O2 K7 K8 R2 T1
2222 052 T2 Z2

2263 051 L4 N2 N3 O2 K7 K8 R3 T1
2263 052 T2 Z2 B3 B7 R2

2297 051 L4 N2 N3 O2 K7 K8 R2 T1
2297 052 T2 Z2

2287 050 B8 L4 N2 N3 O2 K7 K8 R3
T1 T2 Z2 B3 R2

2283 050 L4 N2 N3 O2 K7 K8 R2 T1
T2 Z2

2280 051 L4 N2 N3 O2 K7 K8 R3 T1
2280 052 T2 Z2 B3 R3 R2

2278 050 B3 B8 L4 N2 N3 O2 K7 K8
2266 050 R3 T1 T2 Z2 R2

2279 050 N2 N3 O2 K7 K8 R2 T1 T2
2269 050 Z2

2272 050 B7 L4 N2 N3 O2 K7 K8 R3
2265 050 T1 T2 Z2 B3 R2

2274 050 B3 L4 N2 N3 O2 K7 K8 R3
2264 050 T1 T2 Z2 B3

2157 050 B3 B8 L4 N2 N3 O2 K7 K8
R3 T1 T2 Z2 R2

2155 050 B3 B7 L4 N2 N3 O2 K7 K8
R3 T1 T2 Z2 R2

2154 050 B3 L4 N2 N3 O2 K7 K8 R3
T1 T2 Z2 R2

2156 050 B6 L4 N2 N3 O2 K7 K8 R3
T1 T2 Z2 R2

See page 298

2211 051 rh | 2211 052 lh

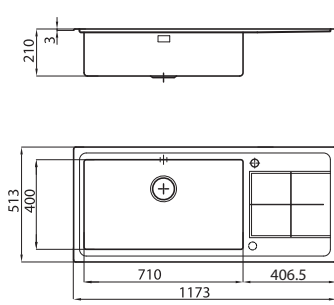

2222 051 rh | 2222 052 lh

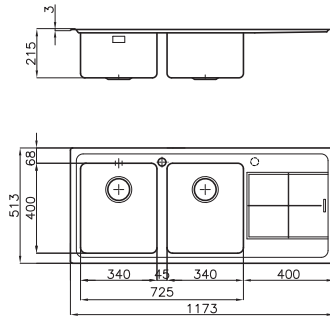

2263 051 rh | 2263 052 lh

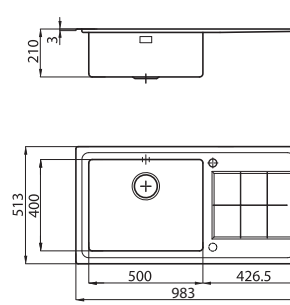

2297 051 rh | 2297 052 lh

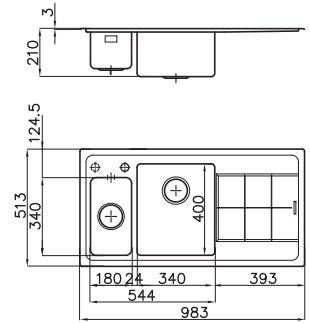

2287 050

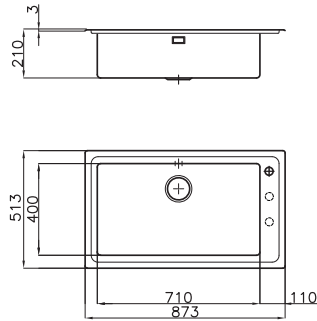

2283 050

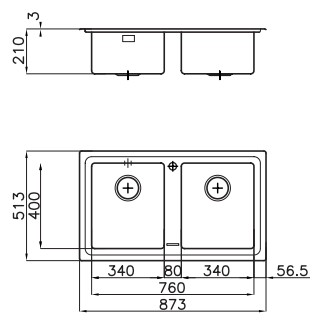

2280 051 rh | 2280 052 lh

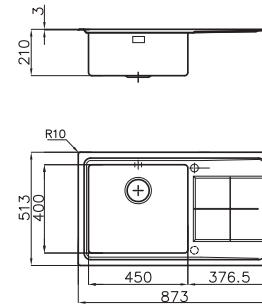

KE Q4 and flush-mount

2278 050 | 2266 050

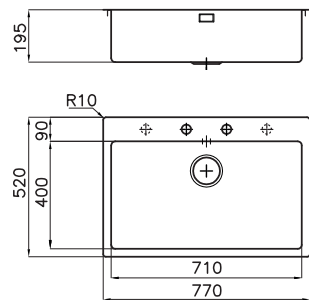

2279 050 | 2269 050

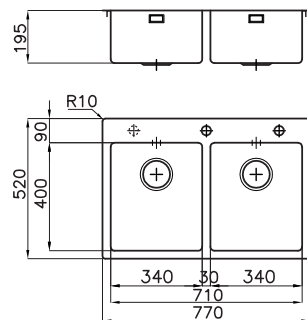

2272 050 | 2265 050

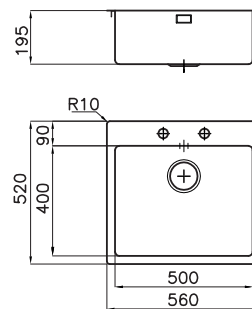

2274 050 | 2264 050

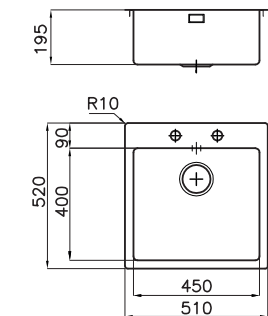

KE flush-mount bowls

2157 050

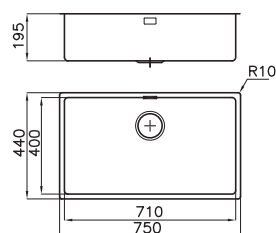

2155 050

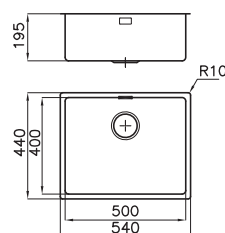

2154 050

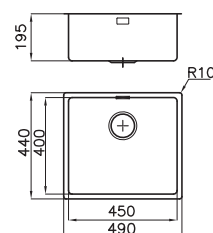

2156 050

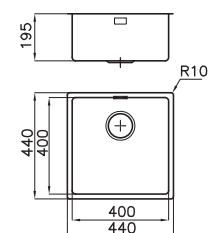

Stripe

flat edge

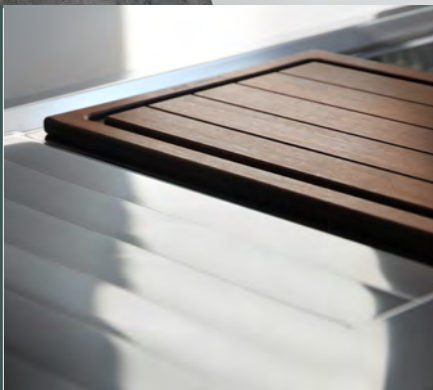

The elegant striped

drainer is both a support surface and a water drainage area.

Stripe

flat edge

Code

Version

Characteristics

Price

Cabinet 80/(90)^T (see page 16)

4504 051 rh
4504 052 lh



cut-out: 1140 x 480



- Satin finish AISI 304 stainless steel
- Dimensions: **1173 x 513** - 1 bowl: **750 x 350**
- 3½" PM automatic waste fitting

Included: **knives-holder element**

Accessories and technical drawing on page 166

Cabinet 80/(90)^T (see page 16)

4503 051 rh
4503 052 lh



cut-out: 1140 x 480



- Satin finish AISI 304 stainless steel
- Dimensions: **1173 x 513** - 2 bowls: **365 x 350**
- 3½" PM automatic waste fitting
- Additional holes available

Accessories and technical drawing on page 166

Cabinet 60

4500 051 rh
4500 052 lh



cut-out: 840 x 480



- Satin finish AISI 304 stainless steel
- Dimensions: **873 x 513** - 1 bowl: **500 x 350**
- 3½" PM automatic waste fitting
- Additional holes available

Accessories and technical drawing on page 166

Stripe

flat edge

Code

Version

Characteristics

Price

Cabinet 80/(90)^T (see page 16)

4502 050



cut-out: 840 x 480



- Satin finish AISI 304 stainless steel
- Dimensions: **873 x 513** - 2 bowls: **365 x 350**
- 3/2" PM automatic waste fitting
- Additional holes available

Accessories at the bottom of the page

Cabinet 60

4505 050



cut-out: 570 x 480



- Satin finish AISI 304 stainless steel
- Dimensions: **603 x 513** - 1 bowl: **500 x 350**
- 3/2" PM automatic waste fitting
- Additional holes available

Accessories at the bottom of the page

accessories



B4

Black grid
36.8 x 34.2 cm
8100 618



P3

Iroko wood chop-
ping board 26 x
36.6 cm
8643 117



T6

Stainless steel
plate rack 23 x 37.5
8100 305

4504 051 **B4** **P3** **T6**
4504 052

4503 051 **P3** **T6**
4503 052

4500 051 **B4** **P3** **T6**
4500 052

4502 050 **P3** **T6**

4505 050 **B4** **P3** **T6**

4504 051 rh | 4504 052 lh

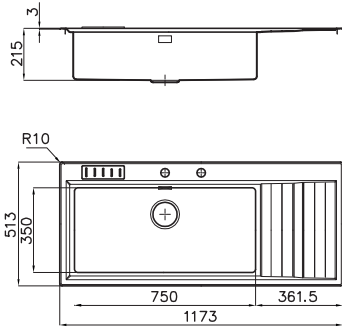

4503 051 rh | 4503 052 lh

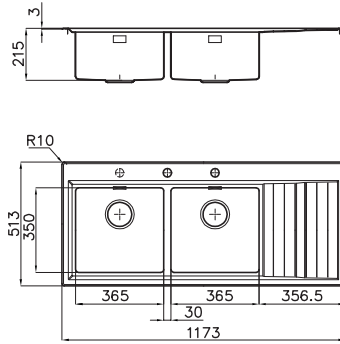

4500 051 rh | 4500 052 lh

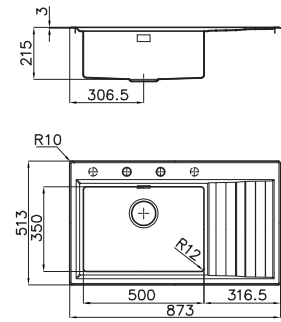

4502 050

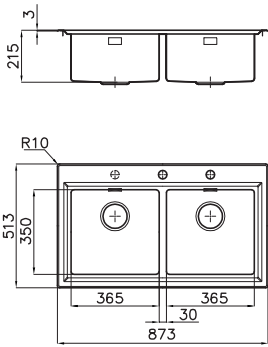

4505 050

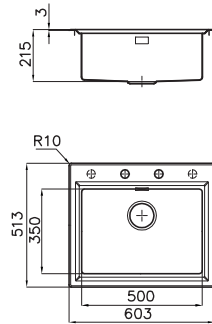

EVO Series **NEW**
standard



EVO Series | The largest bowl
of the entire Foster production

EVO Series NEW

standard

Code

Version

Characteristics

Price

Cabinet 90

3216 051 rh
3216 052 lh



cut-out: 1140 x 480



- Satin finish AISI 304 stainless steel
- Dimensions: **1160 x 500** - 1 bowl: **730 x 400**
- 3½" waste fitting
- Additional holes available
- Plus version with deep bowl

Accessories, technical drawing and automatic waste fittings on page 172

SINKS

Cabinet 90 NEW

3219 051 rh
3219 052 lh



cut-out: 1140 x 480



- Satin finish AISI 304 stainless steel
- Dimensions: **1160 x 500** - 1 bowl: **730 x 400**
- 3½" waste fitting
- Additional holes available

Accessories, technical drawing and automatic waste fittings on page 172

Cabinet 80/(90)^T (see page 16)

3212 051 rh
3212 052 lh



cut-out: 1140 x 480



- Satin finish AISI 304 stainless steel
- Dimensions: **1160 x 500** - 2 bowls: **340 x 400**
- 3½" waste fitting
- Additional holes available

Accessories, technical drawing and automatic waste fittings on page 172

EVO Series **NEW**
standard



EVO Series NEW

standard

Code	Version	Characteristics	Price
------	---------	-----------------	-------

Cabinet 60

3218 001 rh
3218 002 lh  **STD** cut-out: 840 x 480



- Satin finish AISI 304 stainless steel
- Dimensions: **860 x 500** - 1 bowl: **450 x 400**
- 3½" waste fitting
- Additional holes available

Accessories, technical drawing and automatic waste fittings on page 172

Cabinet 80/(90)^T (see page 16)

3274 050  **STD** cut-out: 840 x 480



- Satin finish AISI 304 stainless steel
- Dimensions: **860 x 500** - 2 bowls: **340 x 400**
- 3½" waste fitting

Accessories, technical drawing and automatic waste fittings on page 172

Cabinet 60 NEW

3217 000  **STD** cut-out: 560 x 480



- Satin finish AISI 304 stainless steel
- Dimensions: **590 x 500** - 1 bowl: **500 x 350**
- 3½" waste fitting
- Additional holes available

Accessories, technical drawing and automatic waste fittings on page 172

EVO Series accessories

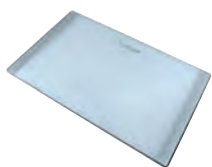

L4
Glass chopping board 23x41 cm
8631 300



L5
Glass chopping board 29x54 cm
8633 300



P3
Chopping board 26x36.6 cm
8643 117



N2
HDPE chopping board 27.2x42.5 cm
8657 001



N3
HDPE Twin chopping board 31.7x42.5 cm
8644 101



O2
White bowl 27.2x41.4 cm
8153 100



K7
Iroko wood chopping board kit 42 x 31.7 cm with stainless steel colander
8644 044



K8 *
Graters kit with frame and food tray
8159 101



Z4
White colander 17x32 cm
8151 100



R2
Stainless steel basket 34x40 cm
8611 000



R3
Stainless steel basket 40x40 cm
8612 000



T6
Stainless steel plate rack 23x37.5 cm
8100 305



T2 *
Stainless steel plate rack 21.4x37.9 cm
8100 303



Z2 *
Stainless steel perforated tray 21.5x38 cm
8151 000

Also available in version PVD



Gun Metal
8151 006



Copper
8151 008



Gold
8151 009

* only usable in combination with chopping board N3

3219 051 L4 L5 N3 O2 K8 R3 T2 Z4
3219 052 N2 R2 K7 Z2

3216 051 L4 L5 N3 O2 K8 R3 T2 Z4
3216 052 N2 R2 K7 Z2

3212 051 L4 L5 N3 O2 K8 R3 T2 Z4
3212 052 N2 R2 K7 Z2

3218 001 L4 L5 N3 O2 K8 R3 T2 Z4
3218 002 N2 R2 K7 Z2

3274 050 L4 L5 N3 O2 K8 R3 T2 Z4
Z4 N2 R2 K7 Z2

3217 000 T6 P3 O2 Z4 Z2

optional automatic waste fittings

3219 051 PA PE PM PL PP
3219 052

3216 051 PA PE PM PL PP
3216 052

3212 051 PA PE PM PL PP
3212 052

3218 001 PA PE PM PL PP
3218 002

3274 050 PA PE PM PL PP

3217 000 PA PE PM PL PP

See page 298

EVO Series | technical drawings

3216 051 rh | 3216 052 lh

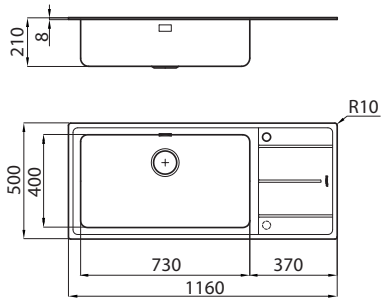

3219 051 rh | 3219 052 lh **NEW**

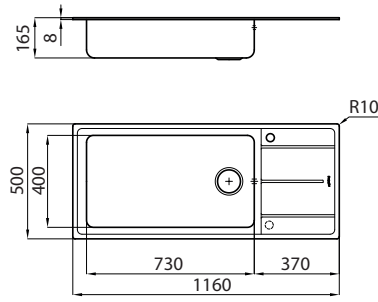

3212 051 rh | 3212 052 lh

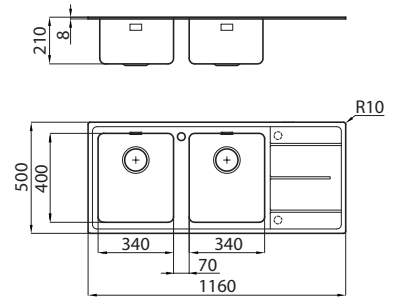

3218 001 rh | 3218 002 lh

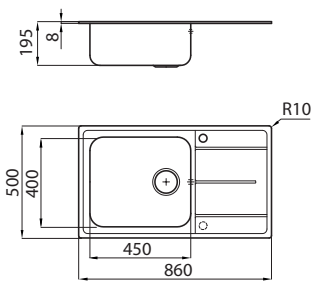

3274 050

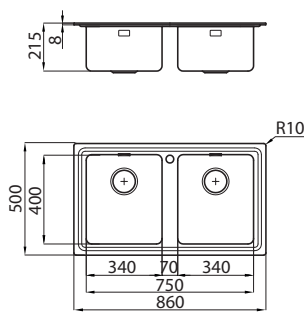

3217 000 **NEW**

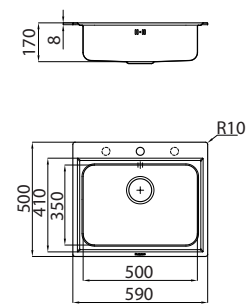

Elettra

standard



Cabinet 80/(90)^T (see page 16)

Code	Version	Characteristics	Price
5812 061 rh 5812 062 lh	 STD	cut-out: 1140 x 480	



- Satin finish AISI 304 stainless steel
- Dimensions: **1160 x 500** - 2 bowls: **340 x 400**
- 3/2" waste fitting
- Additional holes available

Accessories, technical drawing and automatic waste fittings on page 176

Elettra standard

Code

Version

Characteristics

Price

Cabinet 60



5197 061 rh
5197 062 lh



cut-out: 950 x 480

- Satin finish AISI 304 stainless steel
- Dimensions: **970 x 500** - 2 bowls: **340 x 400 + 150 x 300**
- 3½" waste fitting
- Additional holes available

Accessories, technical drawing and automatic waste fittings on page 176

SINKS

Cabinet 80/(90)^T (see page 16)



5886 060



cut-out: 840 x 480

- Satin finish AISI 304 stainless steel
- Dimensions: **860 x 500** - 2 bowls: **340 x 400**
- 3½" waste fitting

Accessories and technical drawing on page 176

Cabinet 45



5186 061 rh
5186 062 lh



cut-out: 840 x 480

- Satin finish AISI 304 stainless steel
- Dimensions: **860 x 500** - 1 bowl: **340 x 400**
- 3½" waste fitting
- Additional holes available

Accessories, technical drawing and automatic waste fittings on page 176

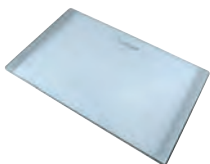

L4

Glass chopping board 23x41 cm
8631 300

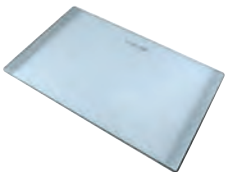

L5

Glass chopping board 29x54 cm
8633 300



N2

HDPE chopping board 27.2x42.5 cm
8657 001



O2

White bowl 27.2x41.4 cm
8153 100



Z4

White colander 17x32 cm
8151 100



R2

Stainless steel basket 34x40 cm
8611 000



Z1

Stainless steel colander 17x32 cm
8154 043



K7

Iroko wood chopping board kit 42 x 31.7 cm with stainless steel colander
8644 044

5812 061 **L4 L5 N2 O2 R2 K7 Z4**
5812 062

5197 061 **L4 L5 N2 O2 Z4 R2 Z1 K7**
5197 062

5886 060 **L4 L5 N2 O2 R2 K7 Z4**

5186 061 **L4 L5 N2 O2 R2 K7 Z4**
5186 062

optional automatic waste fittings

5812 061 **PR PC PQ**
5812 062

5197 061 **PR PC PQ**
5197 062

5886 060 **PR PC PQ**

5186 061 **PR PC PQ**
5186 062

See page 298

5812 061 rh | 5812 062 lh

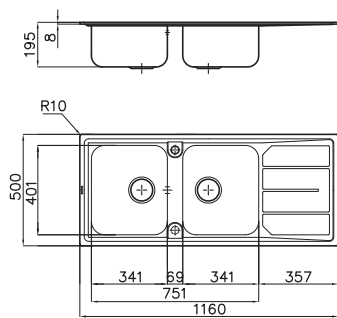

5197 061 rh | 5197 062 lh

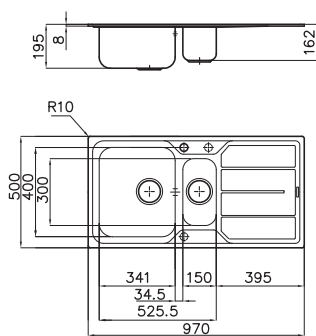

5886 060

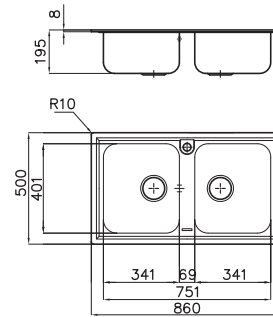

5186 061 rh | 5186 062 lh

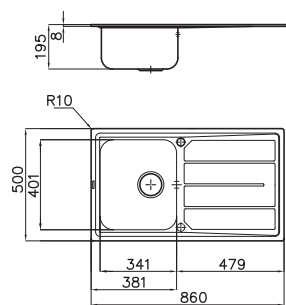

FM
standard



Seamless **surface continuity**
which ensures cleanliness and
sturdiness

Large bowls
and **Drainer**

FM

standard

Code

Version

Characteristics

Price

Cabinet 80/(90)^T (see page 16)

1972 061 rh
1972 062 lh



cut-out: 1140 x 480



- Satin finish AISI 304 stainless steel
- Dimensions: **1160 x 500** - 2 bowls: **362.5 x 400**
- 3½" waste fitting
- Additional holes available

Accessories, technical drawing and automatic waste fittings on page 182

Cabinet 80/(90)^T (see page 16)

1974 060



cut-out: 840 x 480



- Satin finish AISI 304 stainless steel
- Dimensions: **860 x 500** - 2 bowls: **362.5 x 400**
- 3½" waste fitting

Accessories and technical drawing on page 182

Cabinet 45

1971 061 rh
1971 062 lh



cut-out: 840 x 480



- Satin finish AISI 304 stainless steel
- Dimensions: **860 x 500** - 1 bowl: **362.5 x 400**
- 3½" waste fitting
- Additional holes available

Accessories, technical drawing and automatic waste fittings on page 182

FM Marine

standard



AISI 316 stainless steel

Greater resistance to the effects of salt, detergents and food acids

The absence of seams

gives the product a greater surface uniformity without porosity, high bacterial removal and corrosion resistance

AISI 316

FM Marine standard

Code

Version

Characteristics

Price

■ Cabinet 80/(90)^T (see page 16)

1972 961 rh
1972 962 lh



cut-out: 1140 x 480



- Satin finish AISI 304 stainless steel
- Dimensions: **1160 x 500** - 2 bowls: **362.5 x 400**
- 3½" waste fitting
- Additional holes available

Accessories, technical drawing and automatic waste fittings on page 182

■ Cabinet 80/(90)^T (see page 16)

1974 960



cut-out: 840 x 480



- Satin finish AISI 304 stainless steel
- Dimensions: **860 x 500** - 2 bowls: **362.5 x 400**
- 3½" waste fitting

Accessories and technical drawing on page 182

■ Cabinet 45

1971 961 rh
1971 962 lh



cut-out: 840 x 480



- Satin finish AISI 304 stainless steel
- Dimensions: **860 x 500** - 1 bowl: **362.5 x 400**
- 3½" waste fitting
- Additional holes available

Accessories, technical drawing and automatic waste fittings on page 182

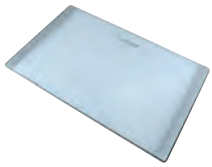

L4

Glass chopping board
23x41 cm
8631 300

1972 061 **L4** **L5** **N2** **R2**
1972 062
1972 961
1972 962

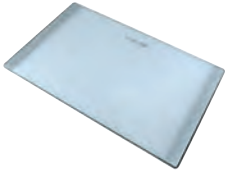

L5

Glass chopping board
29x54 cm
8633 300

1974 060 **L4** **L5** **N2** **R2**
1974 960



N2

HDPE chopping
board 27.2x42.5 cm
8657 001

1971 061 **L4** **L5** **N2** **R2**
1971 062
1971 961
1971 962

optional automatic waste fittings



R2

Stainless steel basket
34x40 cm
8611 000

1972 061 **PR** **PC** **PQ**
1972 062
1972 961
1972 962

1971 061 **PR** **PC** **PQ**
1971 062
1971 961
1971 962

See page 298

1972 061 rh | 1972 062 lh
1972 961 rh | 1972 962 lh

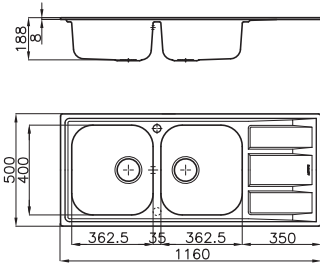

1974 060
1974 960

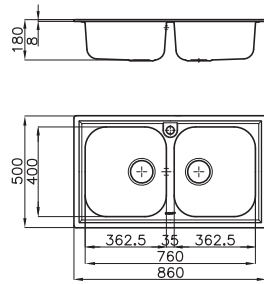

1971 061 rh | 1971 062 lh
1971 961 rh | 1971 962 lh

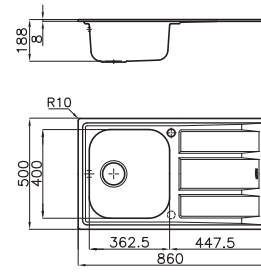

Big Bowl

standard



Cabinet 60



Code	Version	Characteristics	Price
1513 201 rh 1513 202 lh	 STD	cut-out: 1140 x 480	

- Satin finish AISI 304 stainless steel
- Dimensions: **1160 x 500** - 1 bowl: **450 x 400**
- 3/2" waste fitting
- Additional holes available

Accessories, technical drawing and automatic waste fittings on page 186

Cabinet 90



1562 001 rh 1562 002 lh	 STD	cut-out: 840 x 480
----------------------------	---	--------------------

- Satin finish AISI 304 stainless steel
- Dimensions: **STD 860 x 500** - 2 bowls: **450 x 400 + 275 x 400**
- 3/2" waste fitting
- Additional holes available

Accessories, technical drawing and automatic waste fittings on page 186

Big Bowl standard

Code

Version

Characteristics

Price

Cabinet 60

1561 201 rh
1561 202 lh



STD

cut-out: 840 x 480



- Satin finish AISI 304 stainless steel
- Dimensions: **860 x 500** - 1 bowl: **450 x 400**
- 3½" waste fitting
- Additional holes available

Accessories, technical drawing and automatic waste fittings on page 186

Cabinet 60

1511 001 rh
1511 002 lh



STD

cut-out: 570 x 480



- Satin finish AISI 304 stainless steel
- Dimensions: **590 x 500** - 1 bowl: **450 x 400**
- 3½" waste fitting
- Additional holes available

Accessories, technical drawing and automatic waste fittings on page 186

Cabinet 60

1611 060



STD

cut-out: 530 x 480 R 135



- Satin finish AISI 304 stainless steel
- Dimensions: **550 x 500** - 1 bowl: **450 x 400**
- 3½" waste fitting

Accessories, technical drawing and automatic waste fittings on page 186

Big Bowl

accessories

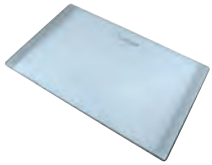

L4

Glass chopping board
23x41 cm
8631 300

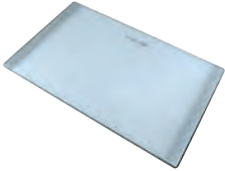

L5

Glass chopping board
29x54 cm
8633 300



N2

HDPE chopping board
27.2x42.5 cm
8657 001



R3

Stainless steel basket
40x40 cm
8612 000



T3

Stainless steel
plate rack 28x40 cm
8100 280

1513 201 L4 L5 N2 R3
1513 202

1562 001 L4 L5 N2 R3 T3
1562 002

1561 201 L4 L5 N2 R3
1561 202

1511 001 L4 L5 N2 R3
1511 002

1611 060 L4 N2 R3

optional automatic waste fittings

1513 201 PR PQ PC
1513 202

1562 001 PR PQ PC
1562 002

1561 201 PR PQ PC
1561 202

1511 001 PR PQ PC
1511 002

1611 060 PR PQ PC

See page 298

Big Bowl | technical drawings

1513 201 rh | 1513 202 lh

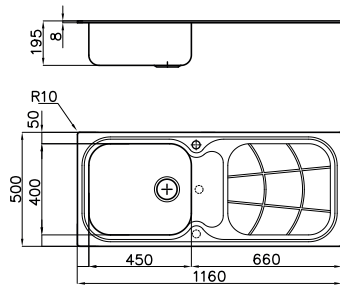

1562 001 rh | 1562 002 lh

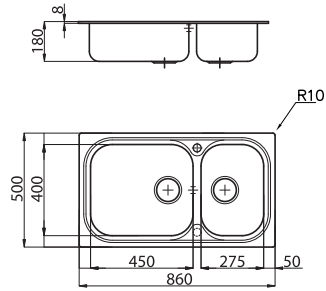

1561 201 rh | 1561 202 lh

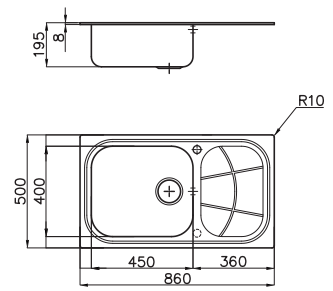

1511 001 rh | 1511 002 lh

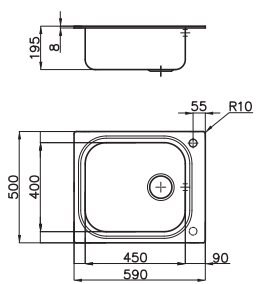

1611 060

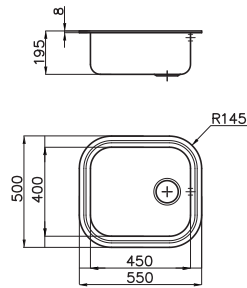

SINKS

Uragano

standard



Cabinet 100

Code

1555 600

Version

 **STD**

Characteristics

cut-out: 950 x 480

Price



- Satin finish AISI 304 stainless steel
- Dimensions: **970 x 500** - 1 bowl: **910 x 440**
- 3/2" waste fitting

Accessories and technical drawing on page 190

Tornado

standard



Cabinet 80

Code

1579 660

Version

 STD

Characteristics

cut-out: 770 x 480

Price



- Satin finish AISI 304 stainless steel
- Dimensions: **790 x 500** - 1 bowl: **730 x 400**
- 3½" automatic waste fitting
- Additional holes available

Accessories and technical drawing on page 190

Cabinet 80

1679 660

 STD

cut-out: 770 x 480 R135



- Satin finish AISI 304 stainless steel
- Dimensions: **790 x 500** - 1 bowl: **730 x 400**
- 3½" automatic waste fitting
- Additional holes available

Accessories and technical drawing on page 190

Uragano and Tornado

accessories



P5

Iroko wood chopping board 37x30 cm
8659 111

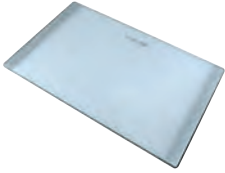

L5

Glass chopping board 29x54 cm
8633 300



P4

Iroko wood Twin chopping board 37x46 cm
8644 003



O1

White bowl 36x30 cm
8152 100



Z4

White colander 17x32 cm
8151 100



T *

Stainless steel plate rack 25x35 cm
8100 154



T7

Stainless steel plate rack 25x45 cm
8100 111



R1

Bowl-holder ring 37x45 cm
8100 112

Uragano
1555 600 **P5 L5 P4 O1 Z4 T T7 R1**

Tornado
1579 660 **P5 L5 P4 O1 Z4 T T7 R1**

1679 660 **P5 L5 P4 O1 Z4 T T7 R1**

* only usable in combination with chopping board P4

Uragano

technical drawings

1555 600

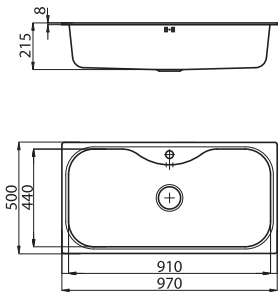

SINKS

Tornado

technical drawings

1579 660

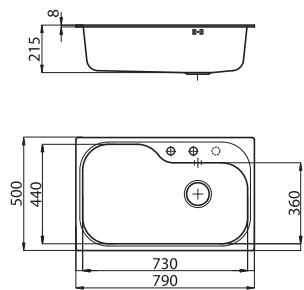

1679 660

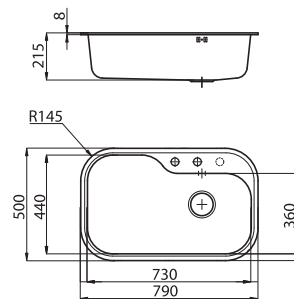

Angolare NEW

standard



Cabinet 90 x90



Accessories, technical drawing and automatic waste fittings on page 194

Code

3303 060

Version

 **STD**

Characteristics

cut-out: see website

Price

- Satin finish AISI 304 stainless steel
- Dimensions: **830 x 830** - 2 bowls: **340 x 400**
- 3½" waste fitting

Linear cabinet 90



Accessories, technical drawing and automatic waste fittings on page 194

3308 050

 **STD**

cut-out: see website

- Satin finish AISI 304 stainless steel
- Dimensions: **830 x 830** - 2 bowls: **400 x 400 - 180 x 340**
- 3½" waste fitting + 1¼" on drainer
- Additional holes available



Angolare accessories

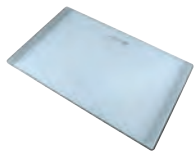

L4

Glass chopping board
23x41 cm
8631 300

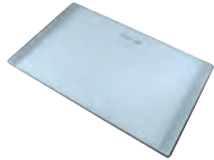

L5

Glass chopping board
29x54 cm
8633 300



N2

HDPE chopping board
27.2x42.5 cm
8657 001



N3

HDPE Twin
chopping board
31.7x42.5
8644 101



O2 *

White bowl
27.2x41.4 cm
8153 100



K7

Iroko wood chopping
board kit 42 x 31.7 cm
with
stainless steel
colander
8644 044



K8 *

Graters kit with frame
and food tray
8159 101



R2

Stainless steel basket
34x40 cm
8611 000



T1

Stainless steel plate
rack 25x42.5 cm
8100 201



Z2 *

Stainless steel
perforated tray
21.5x38 cm
8151 000

Also available in version PVD



Gun Metal
8151 006



Copper
8151 008



Gold
8151 009



T2 *

Stainless steel plate
rack 21.4x37.9 cm
8100 303

3303 060 **L5 N2 O2 R2**

3308 050 **L4 L5 N2 N3 O2 R2 K7 K8**

T1 Z2 T2

optional automatic waste fittings

3308 050 **PR PQ PC**

See page 298

* only usable in combination with chopping board N3

3303 060

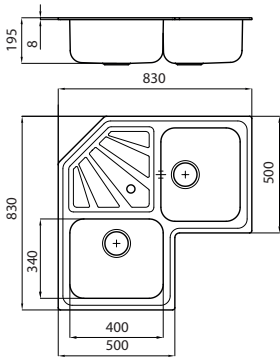

3308 050

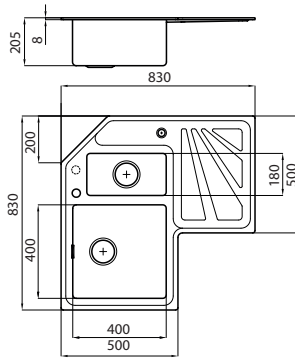

S1000
standard



S1000

standard

Code	Version	Characteristics	Price
------	---------	-----------------	-------

Cabinet 80/(90)^T (see page 16)

1812 161 rh
1812 162 lh  cut-out: 1140 x 480



- Satin finish AISI 304 stainless steel
- Dimensions: **1160 x 500** - 2 bowls: **360 x 400**
- 3½" waste fitting
- Additional holes available

Accessories, technical drawing and automatic waste fittings on page 200

Cabinet 60/(80)^T (see page 16)

1197 161 rh
1197 162 lh  cut-out: 950 x 480



- Satin finish AISI 304 stainless steel
- Dimensions: **970 x 500** - 2 bowls: **340 x 400 + 170 x 340**
- 3½" waste fitting
- Additional holes available

• Also available in version **Microfooster**
1197 461 rh
1197 462 lh



Accessories, technical drawing and automatic waste fittings on page 200

Cabinet 45

1186 161 rh
1186 162 lh  cut-out: 840 x 480



- Satin finish AISI 304 stainless steel
- Dimensions: **860 x 500** - 1 bowl: **340 x 400**
- 3½" waste fitting
- Additional holes available

Accessories, technical drawing and automatic waste fittings on page 200

S1000

standard

Code

Version

Characteristics

Price

■ Cabinet 80/(90)^T (see page 16)

1886 160



cut-out: 840 x 480



- Satin finish AISI 304 stainless steel
- Dimensions: **860 x 500** - 2 bowls: **360 x 400**
- 3/2" waste fitting

Accessories and technical drawing on page 200

■ Cabinet 80

1279 060



cut-out: 770 x 480



- Satin finish AISI 304 stainless steel
- Dimensions: **790 x 500** - 2 bowls: **360 x 400**
- 3/2" waste fitting

Accessories and technical drawing on page 200

■ Cabinet 45

1179 061 rh
1179 062 lh



cut-out: 770 x 480



- Satin finish AISI 304 stainless steel
- Dimensions: **790 x 500** - 1 bowl: **340 x 400**
- 3/2" waste fitting
- Additional holes available

Accessories, technical drawing and automatic waste fittings on page 200

S1000

standard

Cabinet 45



The right version (rh) is with the mixer tap hole on the right; the left version (lh) has the hole on the left.
Technical drawing on page 200

Code	Version	Characteristics	Price
------	---------	-----------------	-------

1144 001 rh  **STD** cut-out: 420 x 480
1144 002 lh

- Satin finish AISI 304 stainless steel
- Dimensions: **440 x 500** - 1 bowl: **360 x 360**
- 2" waste fitting
- Additional holes available

1144 061 rh  **STD** cut-out: 420 x 480
1144 062 lh

- Satin finish AISI 304 stainless steel
- Dimensions: **440 x 500** - 1 bowl: **360 x 360**
- 3½" waste fitting
- Additional holes available

Cabinet 30



Technical drawing on page 200

1129 000  **STD** cut-out: 270 x 480

- Satin finish AISI 304 stainless steel
- Dimensions: **290 x 340** - 1 bowl: **240 x 340**
- 2" waste fitting

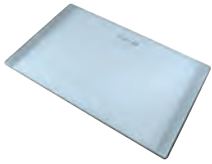

L5

Glass chopping board
29x54 cm
8633 300



N2

HDPE chopping board
27.2x42.5 cm
8657 001



R2

Stainless steel basket
34x40 cm
8611 000

1812 161 **L5 N2 R2**
1812 162

1197 161 **L5 N2 R2**
1197 162

1186 161 **L5 N2 R2**
1186 162

1886 160 **L5 N2 R2**

1279 060 **L5 N2 R2**

1179 061 **L5 N2 R2**
1179 062

optional automatic waste fittings

1812 161 **PR PQ PC**
1812 162

1197 161 **PR PQ PC**
1197 162

1186 161 **PR PQ PC**
1186 162

1179 061 **PR PQ PC**
1179 062

See page 298

S1000 | technical drawings

1812 161 rh | 1812 162 lh

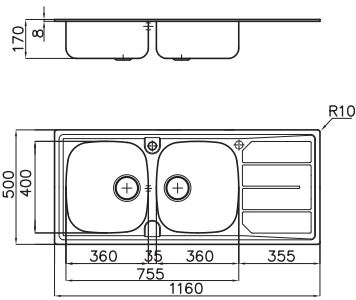

1197 161 rh | 1197 162 lh

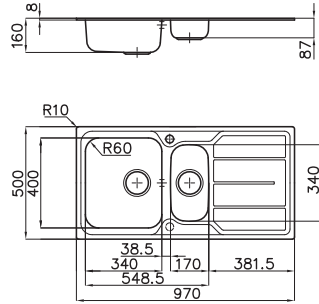

1186 161 rh | 1186 162 lh

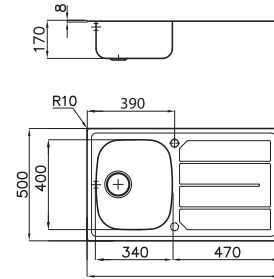

1886 160

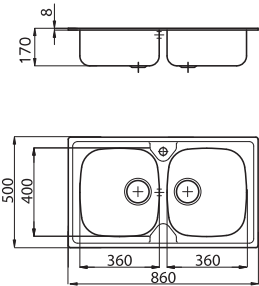

1279 060

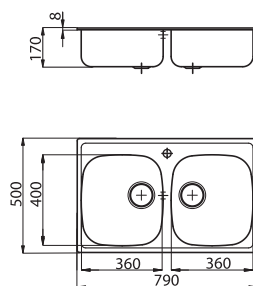

1179 061 rh | 1179 062 lh

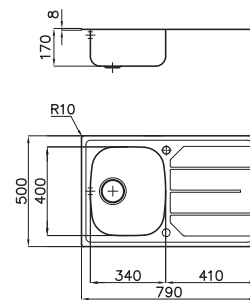

1144 001 rh | 1144 002 lh
1144 061 rh | 1144 062 lh

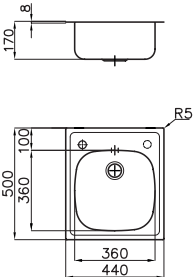

1129 000

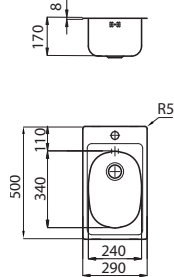

Single bowl S1000

BR



Cabinet 80

Code

1180 150

Version



Characteristics

cut-out: 840 x 480

Price



- Satin finish AISI 304 stainless steel
- Dimensions: **865 x 505** - 1 bowl: **726 x 350**
- 3/2" waste fitting
- Additional holes available

• Also available in version **Gun Metal**

Gun Metal
1180 156



page 33

accessories

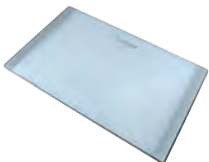

L5

Glass chopping board
29x54 cm
8633 300



P3

Chopping board
26 x 36.6 cm
8643 117

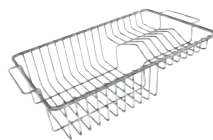

T6

Stainless steel
plate rack 23 x 37.5
8100 305

optional automatic waste fittings

PA PE PM PL PP PS

See page 298

technical drawing

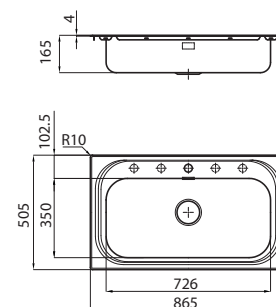

Sinks and bowls | Undermount





UNDERMOUNT
SINKS

Sinks and bowls | Undermount



210 **Phantom Base** 

216 **Phantom** 

222 **Milanello workstation**

228 **Foster Milano**

234 **Quadra EVO** 

240 **Quadra R12** 

246 **Quadra** 

252 **Circolari** 

254 **S4001** 

260 **Series 45**

262 **Series 35**

264 **KE R15** 

272 **KE R15 easy to fix** 

276 **S400**

278 **Big Bowl**

280 **Tornado**

282 **KS R60** 

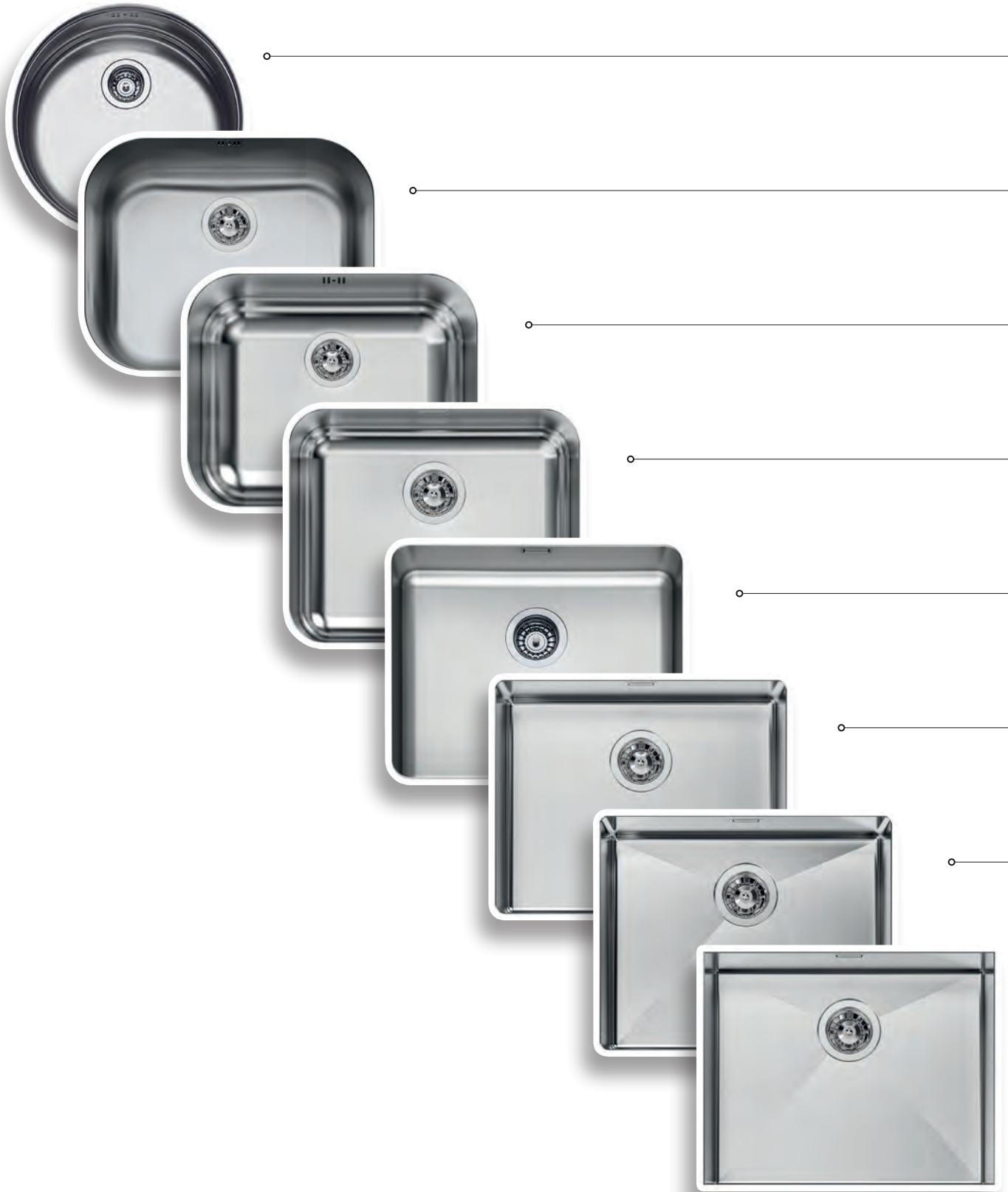

Diameter 380
Circolari

Radius 115
Tornado

Radius 95-50
Big Bowl

Radius 60
KS

Radius 30
S400

Radius 15
KE

Radius 12
Phantom, S4001,
Quadra R12,
Series 45, Series 35

Radius 0
Milanello, Milano,
Phantom Base,
Quadra EVO, Quadra

Phantom Base **NEW**
undermount





The walls are folded and welded at the corners to ensure watertightness and facilitate installation of the slabs forming the bowl



Water drains correctly due to the bottom sloping towards the centre of the drain



The pressed bottom of the bowls facilitates cleaning operations thanks to the sloping side walls

Phantom Base NEW

undermount

Cabinet 80



Accessories, technical drawing and automatic waste fittings on page 214

Code	Version	Characteristics	Price
------	---------	-----------------	-------

5557 240



For 20 mm thick slabs
Dimensions: **756 x 446**
1 bowl: **716 x 406**

- Cut-out: see website
- Satin finish AISI 304 stainless steel bottom
- 3/2" waste fitting + universal corrugated pipe for installing different overflows

• Also available in version **PVD**

Gun Metal
5557 246



page 22

Copper
5557 248



page 46

Gold
5557 249



page 64

Cabinet 60



Accessories, technical drawing and automatic waste fittings on page 214

5555 240



For 20 mm thick slabs
Dimensions: **546 x 446**
1 bowl: **506 x 406**

- Cut-out: see website
- Satin finish AISI 304 stainless steel bottom
- 3/2" waste fitting + universal corrugated pipe for installing different overflows

• Also available in version **PVD**

Gun Metal
5555 246



page 22

Copper
5555 248



page 46

Gold
5555 249



page 64

Cabinet 60



Accessories, technical drawing and automatic waste fittings on page 214

5554 240



For 20 mm thick slabs
Dimensions: **446 x 446**
1 bowl: **406 x 406**

- Cut-out: see website
- Satin finish AISI 304 stainless steel bottom
- 3/2" waste fitting + universal corrugated pipe for installing different overflows

• Also available in version **PVD**

Gun Metal
5554 246



page 22

Copper
5554 248



page 46

Gold
5554 249



page 64

Phantom Base NEW

undermount

Cabinet 80



Accessories, technical drawing and automatic waste fittings on page 214

Code	Version	Characteristics	Price
------	---------	-----------------	-------

5557 340



For 12 mm thick slabs
Dimensions: **740 x 430**
1 bowl: **716 x 406**

- Cut-out: see website
- Satin finish AISI 304 stainless steel bottom
- 3½" waste fitting + universal corrugated pipe for installing different overflows

• Also available in version **PVD**

Gun Metal
5557 346



page 22

Copper
5557 348



page 46

Gold
5557 349



page 64

UNDERMOUNT SINKS

Cabinet 60



Accessories, technical drawing and automatic waste fittings on page 214

5555 340



For 12 mm thick slabs
Dimensions: **530 x 430**
1 bowl: **506 x 406**

- Cut-out: see website
- Satin finish AISI 304 stainless steel bottom
- 3½" waste fitting + universal corrugated pipe for installing different overflows

• Also available in version **PVD**

Gun Metal
5555 346



page 22

Copper
5555 348



page 46

Gold
5555 349



page 64

Cabinet 60



Accessories, technical drawing and automatic waste fittings on page 214

5554 340



For 12 mm thick slabs
Dimensions: **430 x 430**
1 bowl: **406 x 406**

- Cut-out: see website
- Satin finish AISI 304 stainless steel bottom
- 3½" waste fitting + universal corrugated pipe for installing different overflows

• Also available in version **PVD**

Gun Metal
5554 346



page 22

Copper
5554 348



page 46

Gold
5554 349



page 64

Phantom Base **NEW**

accessories



O2

White bowl
27.2x41.4 cm
8153 100



N2

HDPE chopping board
27.2x42.5 cm
8657 001



B6

Black grid
38x38 cm
8100 651

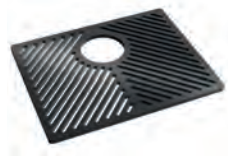

B7

Black grid
38x48 cm
8100 652



B8

Black grid
38x69 cm
8100 653



R3

Stainless steel basket
40x40 - 8612 000



T1

Stainless steel
plate rack 25x42.5 cm
8100 201

5557 340 **O2 N2 B8 R2 T1**
5557 240

5555 340 **O2 N2 B7 R2 T1**
5555 240

5554 340 **O2 N2 B6 R2 T1**
5554 240

optional automatic waste fittings

5557 340 **PL PP PA PR**
5557 240

5555 340 **PL PP PA PR**
5555 240

5554 340 **PL PP PA PR**
5554 240

See page 298

5557 340

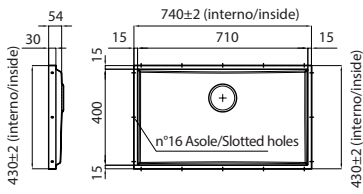

5555 340

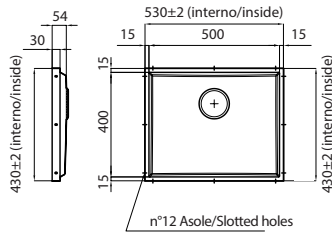

5554 340

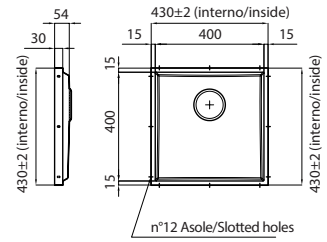

5557 240

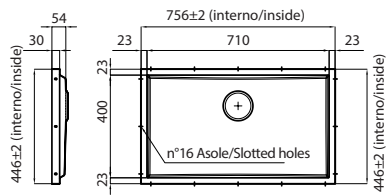

5555 240

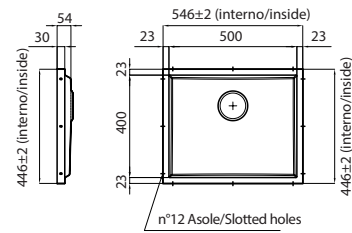

5554 240

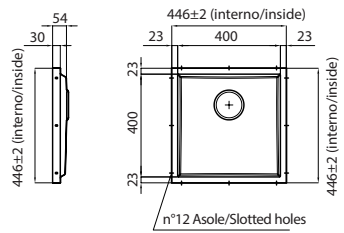

Fixing drawing | Sectional drawings for fixing 12mm or 20 mm thickness

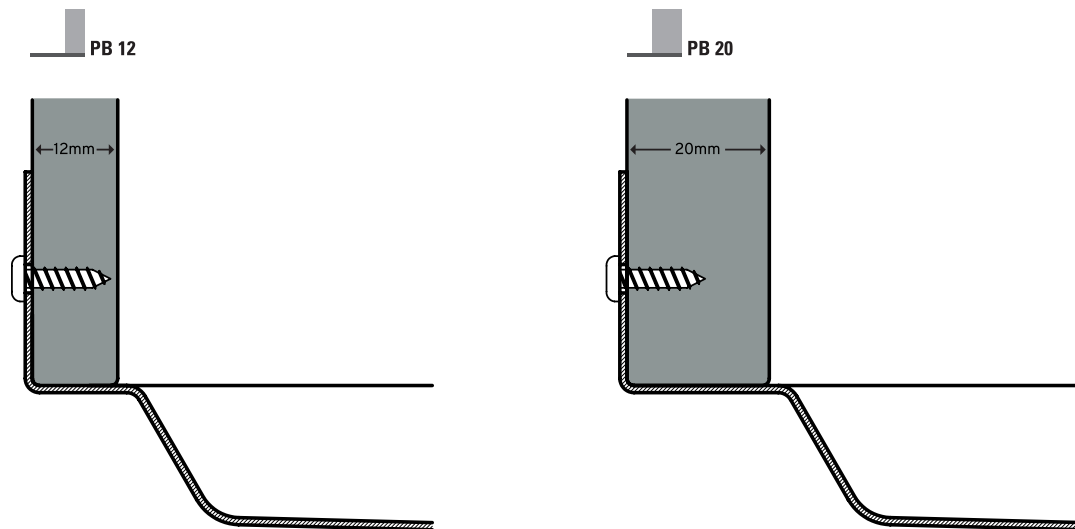

Cut-out for Foster overflow installation

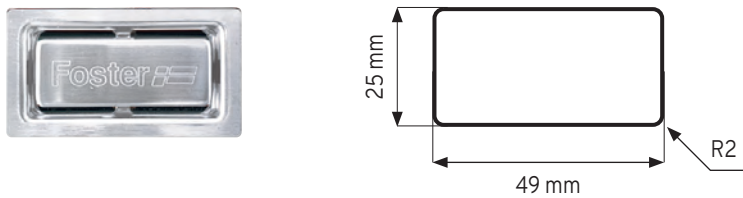

Phantom **NEW**
undermount





The **thin edge** of only 8 mm makes it possible to create a thinner recess in the worktops without causing structural weakening and thus reduce the visible edge of the worktop



Sinks with bowls R12



Installation is **extremely simple** and the customised drop-down makes it easier to centre. The bowls come with special hooks that simplify installation

Phantom NEW undermount

Code	Version	Characteristics	Price
------	---------	-----------------	-------

Cabinet 80

4371 051  **ST** cut-out: see website



- Satin finish AISI 304 stainless steel
- Dimensions: **726 x 416** - 1 bowl: **710 x 400**
- 3½" waste fitting

• Also available in version **PVD**

Gun Metal
4371 056



page 23

Copper
4371 058



page 47

Gold
4371 059



page 65

Accessories, technical drawing and automatic waste fittings on page 220

Cabinet 60

4350 051  **ST** cut-out: see website



- Satin finish AISI 304 stainless steel
- Dimensions: **516 x 416** - 1 bowl: **500 x 400**
- 3½" waste fitting

• Also available in version **PVD**

Gun Metal
4350 056



page 24

Copper
4350 058



page 48

Gold
4350 059



page 66

Accessories, technical drawing and automatic waste fittings on page 220

Cabinet 45

4340 051  **ST** cut-out: see website



- Satin finish AISI 304 stainless steel
- Dimensions: **416 x 416** - 1 bowl: **400 x 400**
- 3½" waste fitting

• Also available in version **PVD**

Gun Metal
4340 056



page 24

Copper
4340 058



page 48

Gold
4340 059



page 66

Accessories, technical drawing and automatic waste fittings on page 220

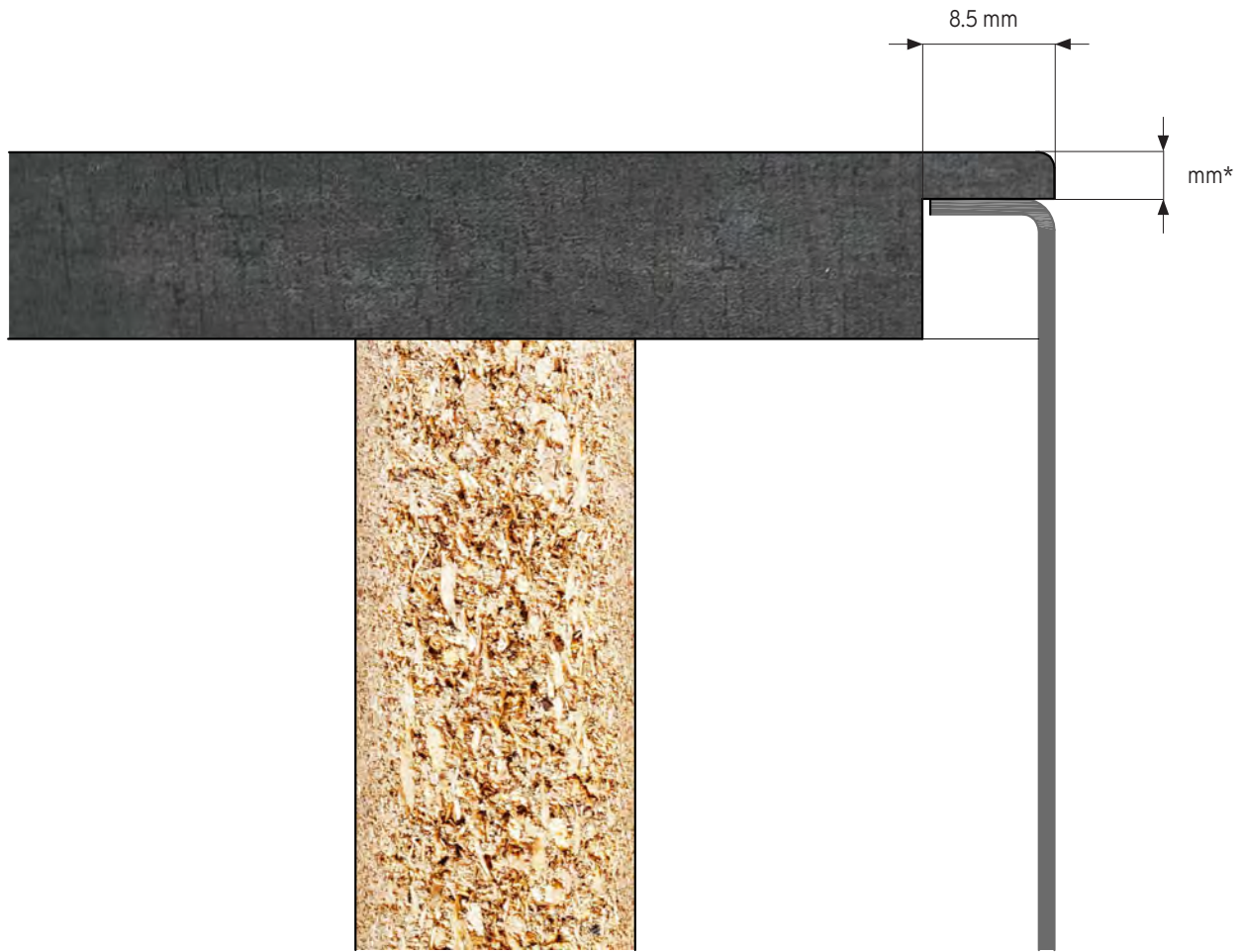

* The minimum thickness must be determined according to the strength of the material

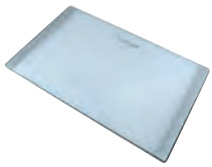

L4

Glass chopping board
23x41 cm
8631 300



N2

HDPE chopping board
27.2x42.5 cm
8657 001



N3

HDPE Twin chopping board
31.7x42.5 cm
8644 101



O2

White bowl
27.2x41.4 cm
8153 100



K8 *

Graters kit with frame
and food tray
8159 101



B3

Black grid
39.2x44.8 cm
8100 617



K7

Iroko wood chopping board with stainless steel colander kit
8644 044

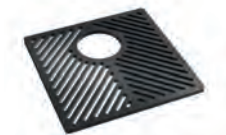

B6

Black grid
38x38 cm
8100 651

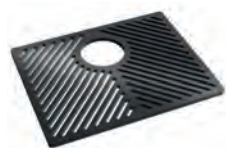

B7

Black grid
38x48 cm
8100 652



B8

Black grid
38x69 cm
8100 653



R2

Stainless steel basket
34x40 cm
8611 000



R3

Stainless steel basket
40x40 - 8612 000

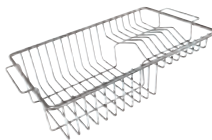

T1

Stainless steel plate rack
25x42.5 cm
8100 201

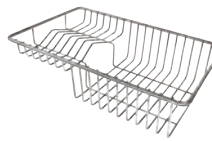

T2 *

Stainless steel plate rack
21.4x37.9 cm
8100 303



Z2 *

Stainless steel perforated tray
21.5x38 cm
8151 000

Also available in version **PVD**



Gun Metal
8151 006



Copper
8151 008



Gold
8151 009

4371 051 **L4 N2 N3 O2 K8 B3 P4 B8**
R2 R3 T1 T2 Z2

4350 051 **L4 N2 N3 O2 K8 B3 P4 B7**
R2 R3 T1 T2 Z2

4340 051 **L4 N2 N3 O2 K8 B3 P4 B6**
R2 R3 T1 T2 Z2

optional automatic waste fittings

4371 051 **PL PP PA PE PM**

4350 051 **PL PP PA PE PM**

4340 051 **PL PP PA PE PM**

See page 298

* only usable in combination with chopping board N3

4371 051

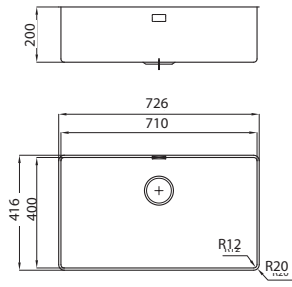

4350 051

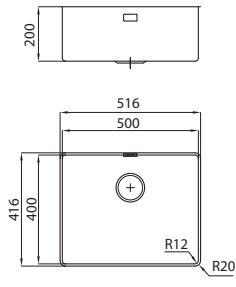

4340 051

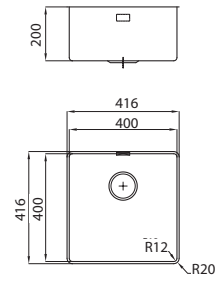

UNDERMOUNT
SINKS

Milanello workstation

undermount





Complete range of accessories

The second step supports a combination of accessories, which make each operation practical: rinsing, draining, slicing, grating... everything can be done inside the sink.

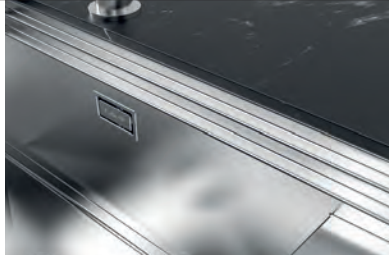

Three-steps system

On the topmost step, the Black grids slide: a large surface to rinse, drain and work.



Protection grids on the bottom

The third step to support the black grids is on the bottom of the bowl. For rinsing without touching the bottom, or for placing items without scratching the steel.

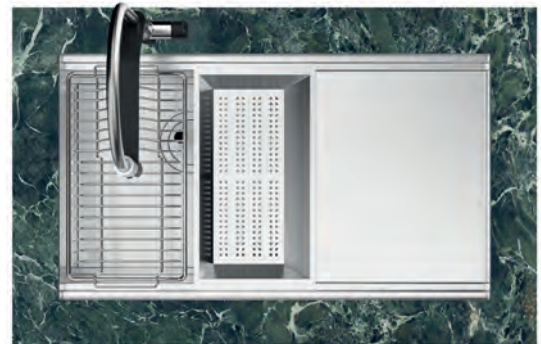
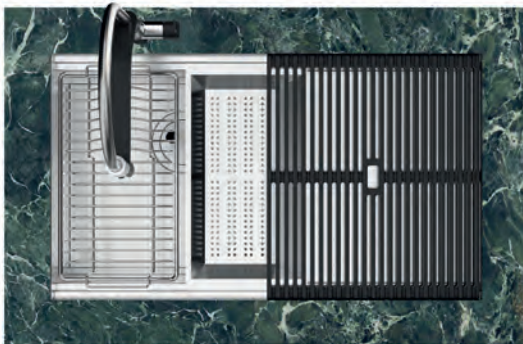

Milanello workstation

undermount

Code

Version

Characteristics

Price

Cabinet 90

1034 850

ST

cut-out: 750 x 426



- Satin finish AISI 304 stainless steel
- Dimensions: **790 x 466** - 1 bowl: **750 x 374**
- SPACE 3½" waste fitting
- Three-steps system

• Also available in version **PVD**

Gun Metal
1034 856



page 25

Copper
1034 858



page 49

Gold
1034 859



page 67

Included: **2 Black grids Milanello** (8100 602)
Accessories, technical drawing and automatic waste fittings on page 226

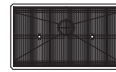

Configuration of Black grids flush with bowl

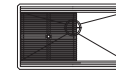

Configuration of Black grids at bottom of bowl

Cabinet 90

1040 851 rh
1040 852 lh

ST

cut-out: 750 x 426



- Satin finish AISI 304 stainless steel
- Dimensions: **790 x 466** - 1 bowl: **430 x 374**
- SPACE 3½" waste fitting
- Three-steps system

Included: **2 Black grids Milanello** (8100 602)
Accessories, technical drawing and automatic waste fittings on page 226

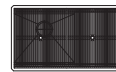

Configuration of Black grids flush with bowl

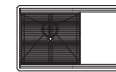

Configuration of Black grids at bottom of bowl

Cabinet 60

1031 850

ST

cut-out: 430 x 426



- Satin finish AISI 304 stainless steel
- Dimensions: **470 x 466** - 1 bowl: **430 x 374**
- SPACE 3½" waste fitting
- Three-steps system

Included: **1 Black grid Milanello** (8100 602)
Accessories, technical drawing and automatic waste fittings on page 226



Configuration of Black grids flush with bowl



Configuration of Black grids at bottom of bowl



UNDERMOUNT
SINKS



Milanello workstation | accessories

optional sliding accessories under the grids



Z3

Stainless steel perforated tray
21.5x40 cm
8156 000

LEV. 2



T8

Stainless steel plate rack
21.4x37.2 cm
8100 306

LEV. 2



P2

Chopping board
39.5 x 22.5 cm
in walnut wood
8642 004

LEV. 2

altri accessori opzionali

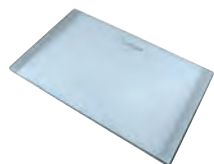

L4

Glass chopping board
23x41 cm
8631 300

LEV. 1



N2

HDPE chopping board
27.2x42.5 cm
8657 001

LEV. 2



N3

HDPE Twin chopping board
31.7x42.5 cm
8644 101

LEV. 1



K8 *

Graters kit with frame and food tray
8159 101



T2 *

Stainless steel plate rack
21.4x37.9 cm
8100 303



Z2 *

Stainless steel perforated tray
21.5x38 cm
8151 000

Disponibile anche in versione PVD



Gun Metal
8151 006



Copper
8151 008



Gold
8151 009



K7

Chopping board kit in Iroko wood
42 x 31.7 cm with stainless steel colander
8644 044

LEV. 1



B5

Black grid
37.2 x 42.4 cm
8100 602

LEV. 1 - 3

1034 850 **Z3 T8 L4 N2 N3 K8 T2 Z2**
K7 P2 B5

1040 851 **Z3 T8 L4 N2 N3 K8 T2 Z2**
1040 852 **K7 P2 B5**

1031 850 **Z3 T8 L4 N2 N3 K8 T2 Z2**
K7 P2 B5

optional automatic waste fittings

1034 850 **PP**

1040 851 **PP**
1040 852

1031 850 **PP**

See page 298

* utilizzabile solo in abbinamento agli accessori N3, K1 e K2

1034 850

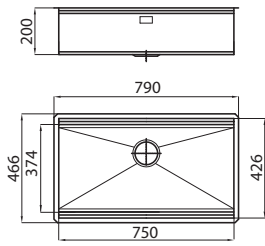

1040 851 rh | 1040 852 lh

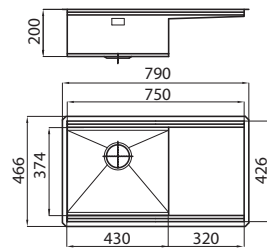

1031 850

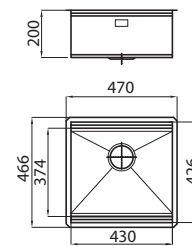

Drawing of position of accessories on steps

The "steps" system makes the combined use of countless accessories possible. Grids, chopping boards, tool holders, trays and containers of various sizes can be moved around the work area with a simple gesture and can be stacked so that they are always within reach.

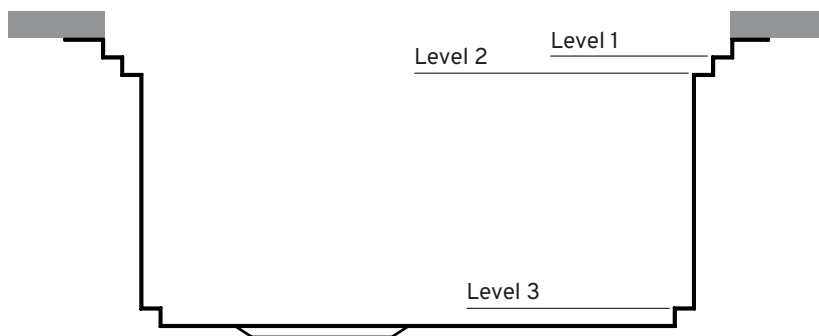

Foster Milano
undermount





Complete range of accessories

The second step supports a combination of accessories, which make each operation practical: rinsing, draining, slicing, grating... everything can be done inside the sink.

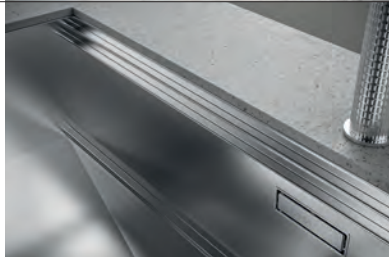

Three-steps system

On the topmost step, the Black grids slide: a large surface to rinse, drain and work.

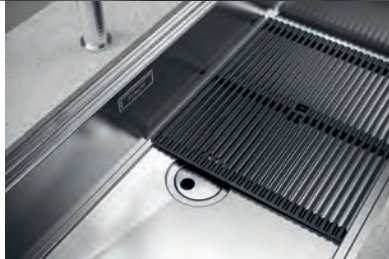

Protection grids on the bottom

The third step to support the black grids is on the bottom of the bowl. For rinsing without touching the bottom, or for placing items without scratching the steel.

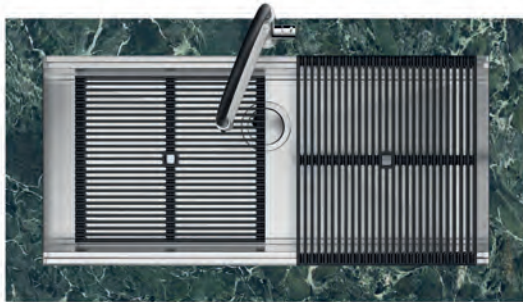

Foster Milano

undermount

Code

Version

Characteristics

Price

Cabinet 120

1015 850



cut-out: 968 x 452



- Satin finish AISI 304 stainless steel
- Dimensions: **1016 x 500** - 1 bowl: **968 x 400**
- SPACE 3½" waste fitting
- Three-steps system

Accessories and technical drawing on page 232



Configuration of
Black grids
flush with bowl



Configuration of
Black grids
at bottom of bowl

Cabinet 120

1016 850



cut-out: 968 x 452



- Satin finish AISI 304 stainless steel
- Dimensions: **1016 x 500** - 2 bowls: **462 x 400**
- SPACE 3½" waste fitting
- Three-steps system

Accessories and technical drawing on page 232



Configuration of
Black grids
flush with bowl



Configuration of
Black grids
at bottom of bowl

Cabinet 90

1014 850



cut-out: 790 x 452



- Satin finish AISI 304 stainless steel
- Dimensions: **838 x 500** - 1 bowl: **790 x 400**
- SPACE 3½" waste fitting
- Three-steps system

Accessories and technical drawing on page 232

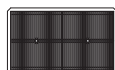

Configuration of
Black grids
flush with bowl



Configuration of
Black grids
at bottom of bowl

Foster Milano

undermount

Cabinet 60

Code	Version	Characteristics	Price
1013 850	ST	cut-out: 462 x 452	



- Satin finish AISI 304 stainless steel
- Dimensions: **510 x 500** - 1 bowl: **462 x 400**
- SPACE 3½" waste fitting
- Three-steps system

Accessories and technical drawing on page 232



Configuration of
Black grids
flush with bowl



Configuration of
Black grids
at bottom of bowl

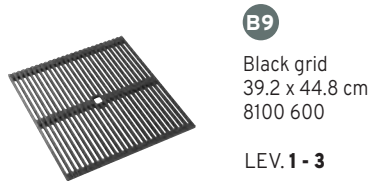

B9
Black grid
39.2 x 44.8 cm
8100 600

LEV. 1 - 3

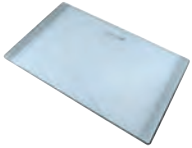

L4
Glass chopping board
23 x 41 cm
8631 300

LEV. 2



K2
Chopping board kit
44.8 x 28.9 cm
8100 037

LEV. 1



K3
Spice holder kit
44.8 x 10 cm
8100 620

LEV. 1



K4
Bottle holder kit
44.8 x 14 cm
8100 621

LEV. 1



K5
Bowls kit
44.8 x 18 cm
8100 622

LEV. 1

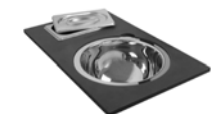

K6
Tray+bowl kit
44.8 x 28 cm
8100 628

LEV. 1



K7
Iroko wood chopping board kit 42 x 31.7 cm with stainless steel colander
8644 044



K8 *
Graters kit with frame and food collection tray
8159 101



P6
Walnut wood chopping board 18 x 44 cm
8642 000



N3
HDPE Twin chopping board
31.7 x 42.5 cm
8644 101

LEV. 2



T2 *
Stainless steel plate rack 21.4 x 37.9 cm
8100 303



Z2 *
Stainless steel perforated tray 21.5 x 38 cm
8151 000

Also available in version PVD



Gun Metal
8151 006



Copper
8151 008



Gold
8151 009



X1 **
Stainless steel perforated tray 12.6 x 12.1 cm
8151 001



X3 ***
Knife holder
8100 030

1015 850 **B9 L4 K2 K3 K4 K5 K6 K7**
K8 M6 N3 T2 Z2 X1 X3

1016 850 **B9 L4 K2 K3 K4 K5 K6 K7**
K8 M6 N3 T2 Z2 X1 X3

1014 850 **B9 L4 K2 K3 K4 K5 K6 K7**
K8 M6 N3 T2 Z2 X1 X3

1013 850 **B9 L4 K2 K3 K4 K5 K6 K7**
K8 M6 N3 T2 Z2 X1 X3

optional automatic waste fittings

1015 850 **PL PP PA PE PM PS**

1016 850 **PL PP PA PE PM PS**

1014 850 **PL PP PA PE PM PS**

1013 850 **PL PP PA PE PM PS**

See page 298

* only usable in combination with chopping board N3

** only usable in combination with kit K2

*** only usable in combination with kit K4

1015 850

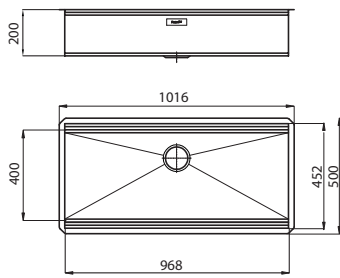

1016 850

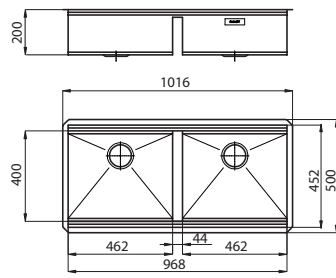

1014 850

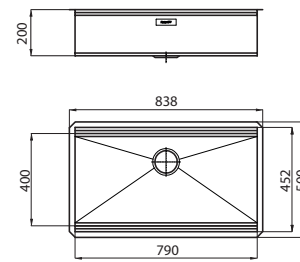

1013 850

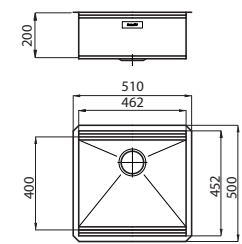

UNDERMOUNT
SINKS

Drawing of position of accessories on steps

The "steps" system makes the combined use of countless accessories possible. Grids, chopping boards, tool holders, trays and containers of various sizes can be moved around the work area with a simple gesture and can be stacked so that they are always within reach.

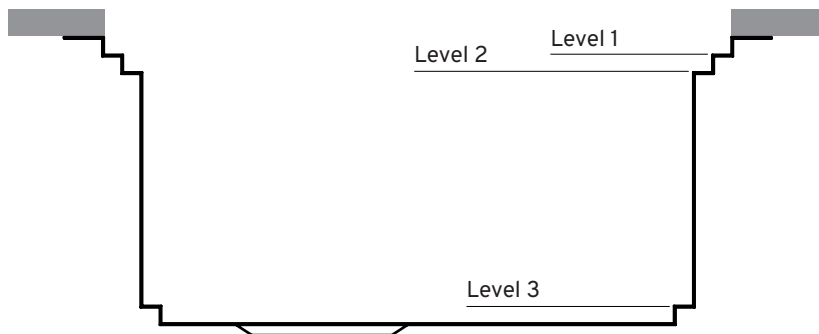

Quadra EVO **NEW**
undermount

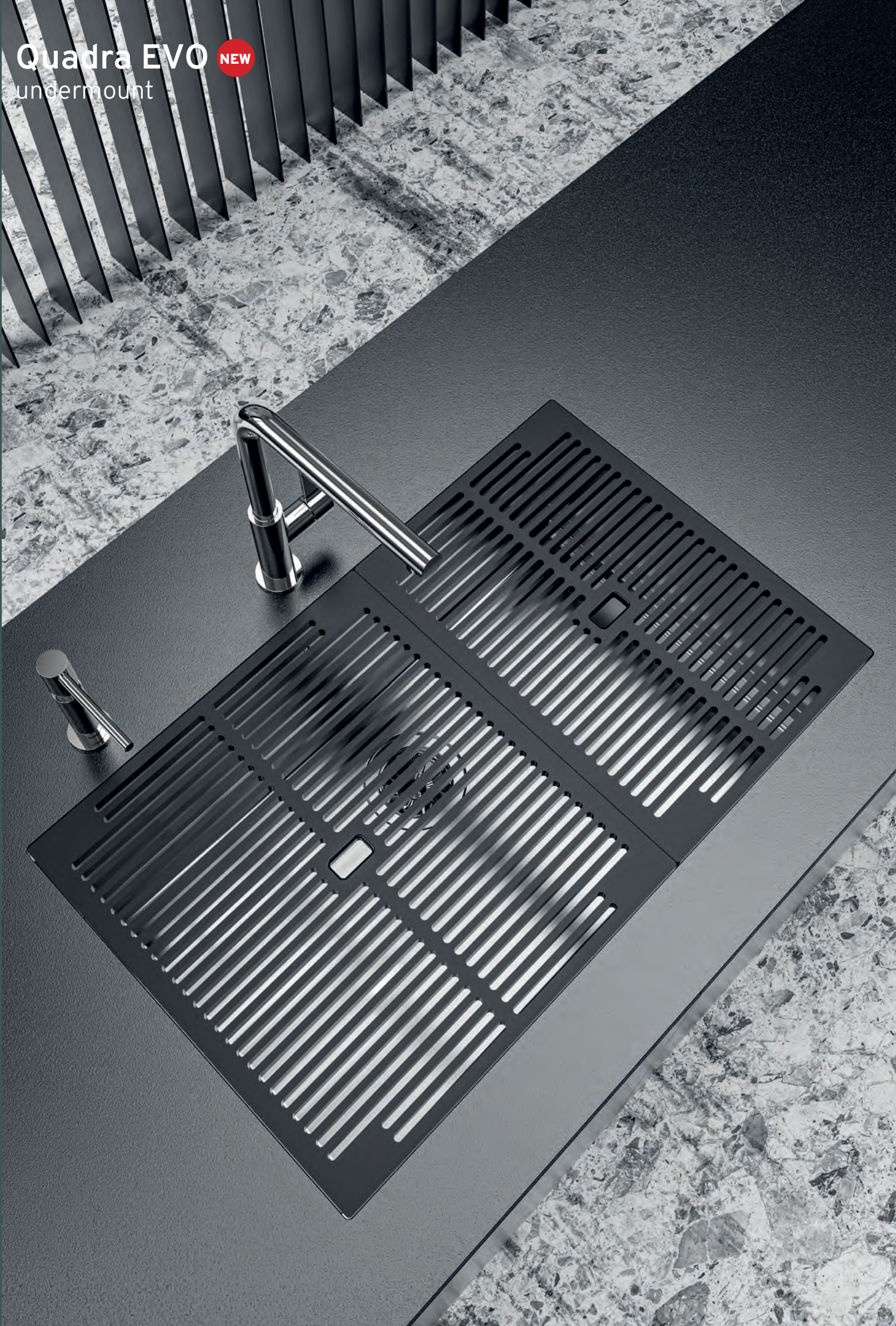



Complete range of accessories

A combination of accessories to make each operation practical: rinsing, draining, slicing, grating... everything can be done inside the sink.



In the positive reveal installation

the 12 mm step ensures that the grid is seamless with the worktop.

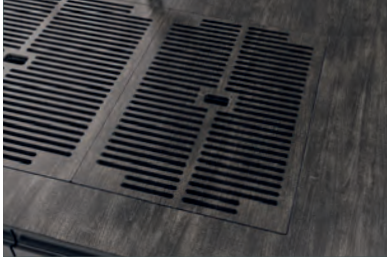

Customised grids available

Cad 3D geometries can be provided on request to make grids in the same material as the worktop.

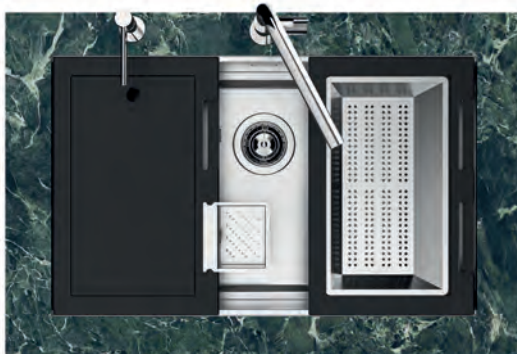
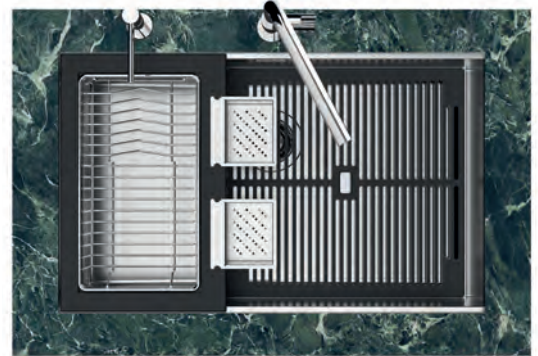

Quadra EVO NEW

undermount

Code	Version	Characteristics	Price
------	---------	-----------------	-------

Cabinet 90

1257 850  **ST** cut-out: 740 x 452 R5



- Satin finish AISI 304 stainless steel
- Dimensions: **780 x 470** - 1 bowl: **740 x 430**
- 3.5" waste fitting

• Also available in version **PVD** **Gun Metal** **1257 856**



page 26

Included: **2 grids** (8100 614 - 8100 615)
Accessories, technical drawing
and automatic waste fittings on page 238



Configuration of
Black grids
flush with bowl



Configuration of
Black grids
at bottom of bowl

Cabinet 80

1255 850  **ST** cut-out: 530 x 452 R5



- Satin finish AISI 304 stainless steel
- Dimensions: **570 x 470** - 1 bowl: **530 x 430**
- 3.5" waste fitting

• Also available in version **PVD** **Gun Metal** **1255 856**



page 27

Included: **1 grid** (8100 615)
Accessories, technical drawing
and automatic waste fittings on page 238



Configuration of
Black grids
flush with bowl



Configuration of
Black grids
at bottom of bowl

Cabinet 60

1254 850  **ST** cut-out: 430 x 452 R5



- Satin finish AISI 304 stainless steel
- Dimensions: **470 x 470** - 1 bowl: **430 x 430**
- 3.5" waste fitting

• Also available in version **PVD** **Gun Metal** **1254 856**



page 27

Included: **1 grid** (8100 615)
Accessories, technical drawing
and automatic waste fittings on page 238



Configuration of
Black grids
flush with bowl

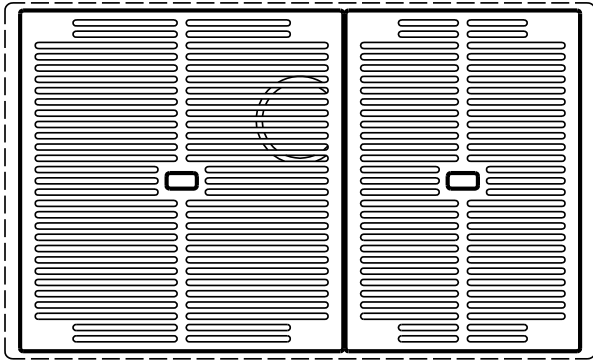

Configuration of **Black grids** 8100 615 + 8100 614 flush with bowl

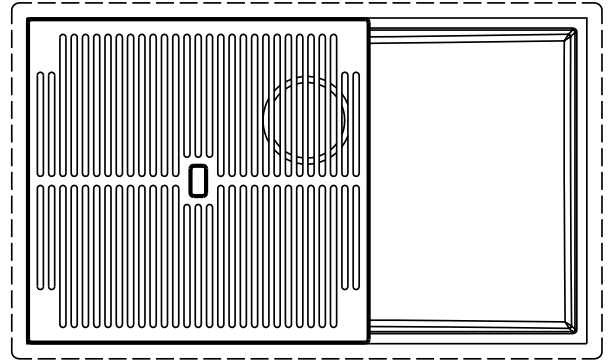

Configuration of **Black grid** 8100 615 resting on perimeter step on the bottom

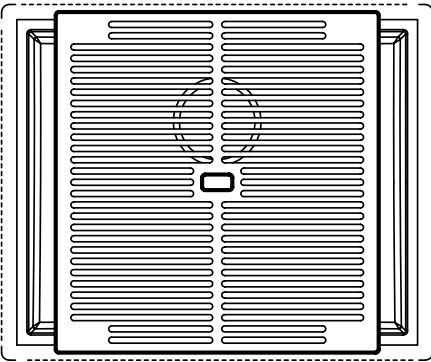

Configuration of **Black grid** 8100 615 flush with bowl

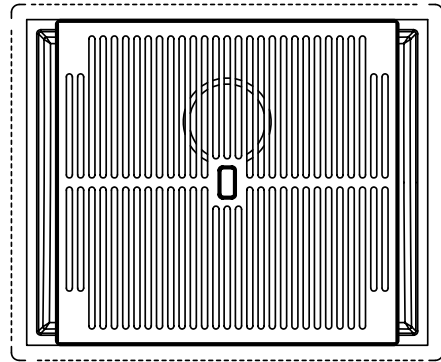

Configuration of **Black grid** 8100 615 resting on perimeter step on the bottom

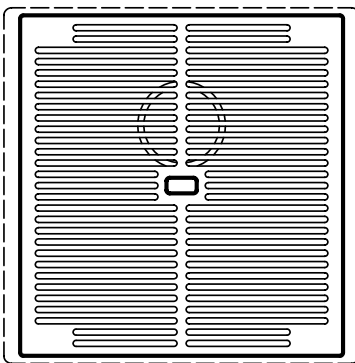

Configuration of **Black grid** 8100 615 flush with bowl

accessories



K2

Chopping board kit
44.8 x 28.9 cm
8100 037

LEV. 1



K3

Spice holder kit
44.8 x 10 cm
8100 620

LEV. 1



K4

Bottle holder kit
44.8 x 14 cm
8100 621

LEV. 1



K5

Bowls kit
44.8 x 18 cm
8100 622

LEV. 1

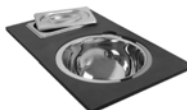

K6

Bowl kit
44.8 x 28 cm
8100 628

LEV. 1



O2

White bowl
41.4x27.2 cm
8153 100

On the bottom



P6

Walnut wood
chopping board
18x44.8 cm
8642 000

LEV. 1



T2 *

Stainless steel
plate rack
21.4x37.9 cm
8100 303



X1 *

Stainless steel
perforated tray
12.6 x 12.1 cm
8151 001



Z2 *

Stainless steel
perforated tray
21.5x38 cm
8151 000

Also available in version **PVD**



Gun Metal
8151 006



Copper
8151 008



Gold
8151 009



B1

Black grid
42.7 x 45 cm
8100 615

LEV. 1 / LEV. 2



B2

Black grid
31 x 45 cm
8100 614

LEV. 1



X3 **

Knife holder
8100 030



K8 *

Graters kit
with frame and food
collection tray
8159 101

1257 050 **K2 K3 K4 K5 K6 O2 P6 T2**
X1 B1 B2 Z2 X3 K8

1255 050 **K2 K3 K4 K5 K6 O2 P6 T2**
X1 B1 B2 Z2 X3 K8

1254 050 **K2 K3 K4 K5 K6 O2 P6 T2**
X1 B1 Z2 X3 K8

optional automatic waste fittings

1257 050 **PL PP PM PA**

1255 050 **PL PP PM PA**

1254 050 **PL PP PM PA**

See page 298

* only usable in combination with kit K2
** only usable in combination with kit K4

1257 850

1255 850

1254 850

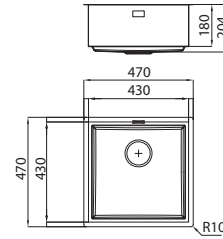
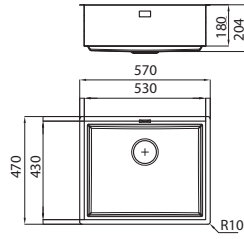
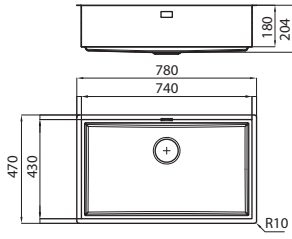

UNDERMOUNT
SINKS

Drawing of position of accessories on steps

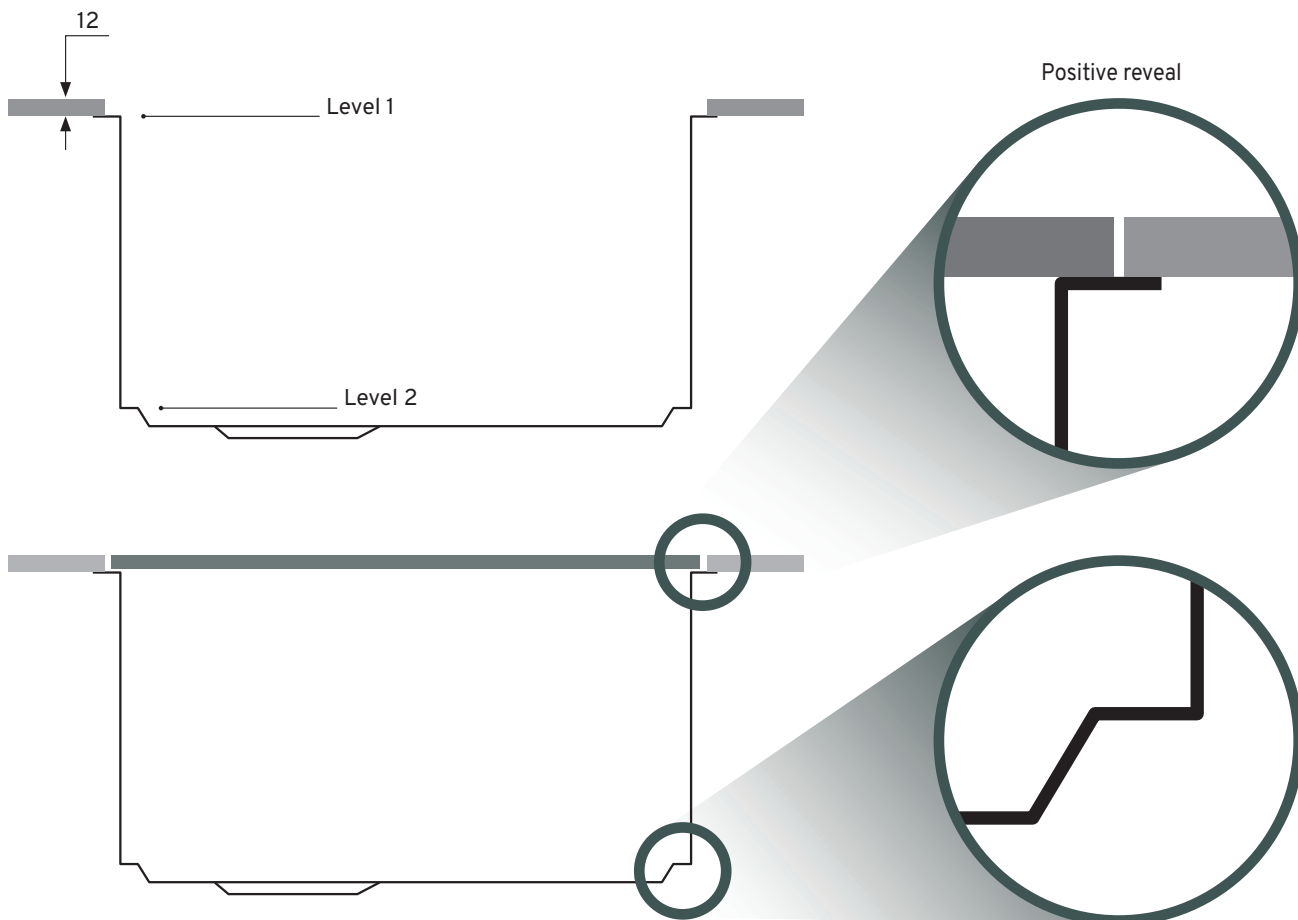

Flush grids can be combined with 12 mm worktops

Quadra R12 NEW
undermount



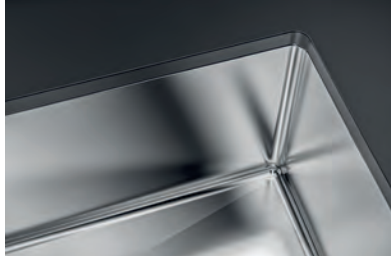

Sinks with bowls R12



The bottom is diamond-shaped



A Black grid is included that can be placed either on the worktop or on the bottom resting on its four rubber feet.

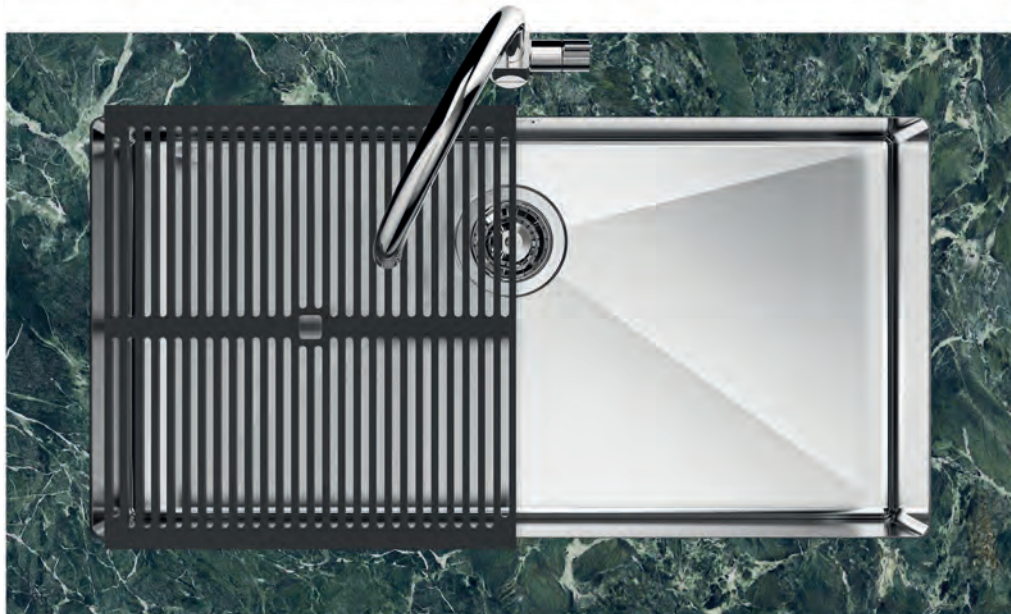

Quadra R12 NEW

undermount

Code

Version

Characteristics

Price

Cabinet 90

1718 850

 ST

cut-out: 800 x 400 R12



- Satin finish AISI 304 stainless steel
- Dimensions: **840 x 440** - 1 bowl: **800 x 400**
- 3.5" waste fitting

Included: **1 grid** (8100 617)
Accessories, technical drawing
and automatic waste fittings on page 244

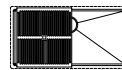

Configuration of
Black grids
flush with bowl

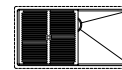

Configuration of
Black grids
at bottom of bowl

Cabinet 80

1717 850

 ST

cut-out: 710 x 400 R12



- Satin finish AISI 304 stainless steel
- Dimensions: **750 x 440** - 1 bowl: **710 x 400**
- 3.5" waste fitting

• Also available
in version **PVD**

Gun Metal

1717 856



page 28

**Gun Metal
Fumé**

1717 816



page 28

Brandy

1717 855



page 83

**Brandy
Fumé**

1717 815



page 83

Included: **1 grid** (8100 617)
Accessories, technical drawing
and automatic waste fittings on page 244



Configuration of
Black grids
flush with bowl

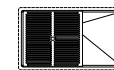

Configuration of
Black grids
at bottom of bowl

Cabinet 60

1715 850

 ST

cut-out: 500 x 400 R12



- Satin finish AISI 304 stainless steel
- Dimensions: **540 x 440** - 1 bowl: **500 x 400**
- 3.5" waste fitting

• Also available
in version **PVD**

Gun Metal

1715 856



page 29

**Gun Metal
Fumé**

1715 816



page 29

Brandy

1715 855



page 83

**Brandy
Fumé**

1715 815



page 83

Included: **1 grid** (8100 617)
Accessories, technical drawing
and automatic waste fittings on page 244



Configuration of
Black grids
flush with bowl



Configuration of
Black grids
at bottom of bowl

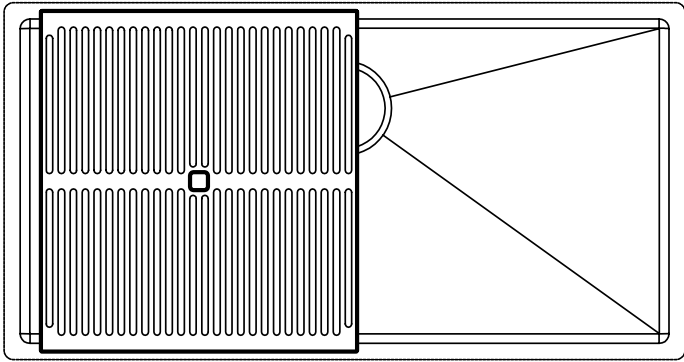

Configuration of **Black grid 8100 617**
resting on the worktop

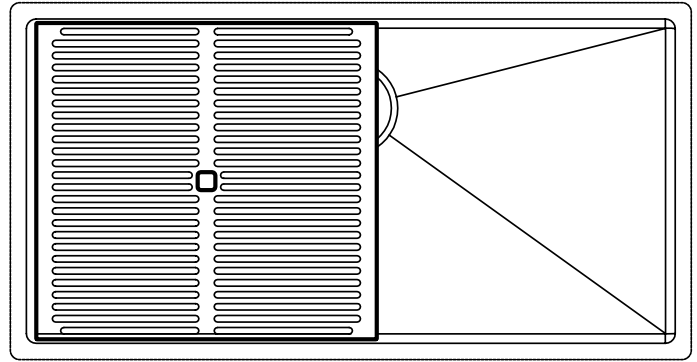

Configuration of **Black grid 8100 617**
resting on the bottom

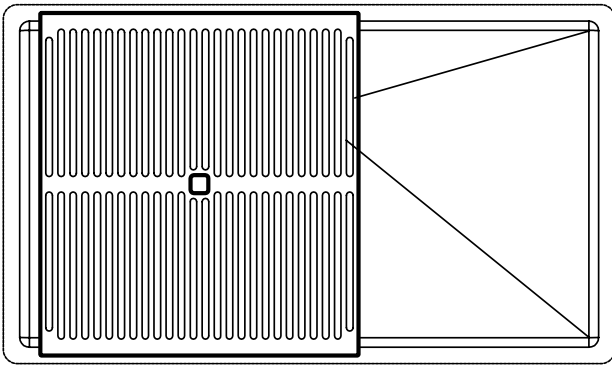

Configuration of **Black grid 8100 617**
resting on the worktop

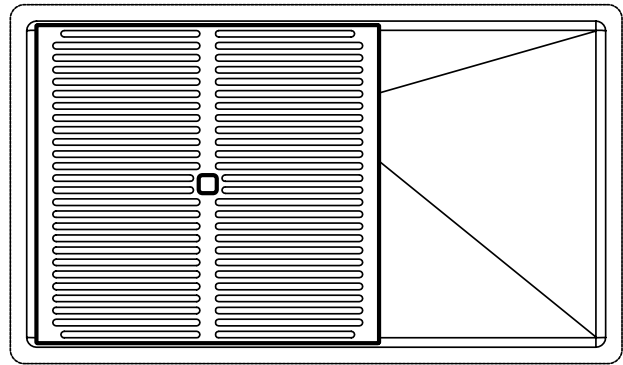

Configuration of **Black grid 8100 617**
resting on the bottom

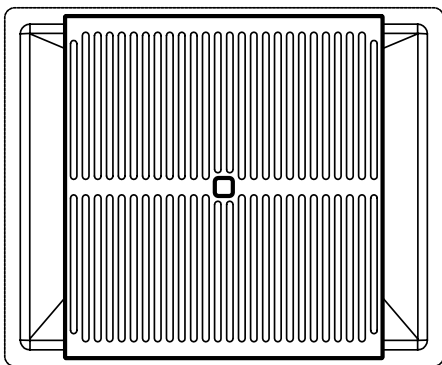

Configuration of **Black grid 8100 617**
resting on the worktop

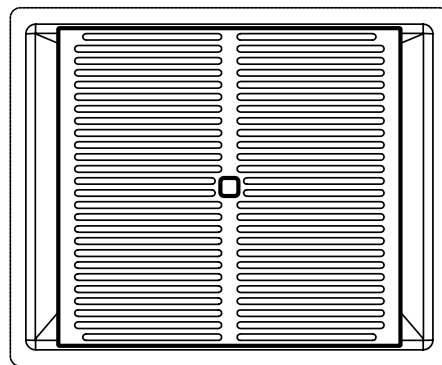

Configuration of **Black grid 8100 617**
resting on the bottom



B3

Black grid
39 x 42 cm
8100 617



K7

Iroko wood chop-
ping board kit 42 x
31.7 cm
with stainless steel
colander
8644 044



K8 *

Graters kit
with frame
and food collection
tray
8159 101

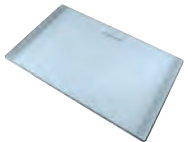

L4

Glass chopping board
23x41 cm
8631 300



N2

HDPE
chopping board
27.2x42.5 cm
8657 001



N3

HDPE Twin chopping
board 31.7x42.5 cm
8644 101



O2

White bowl
41.4x27.2 cm
8153 100



R2

Stainless steel basket
34x40 cm
8611 000



T1

Stainless steel
plate rack
25x42.5 cm
8100 201

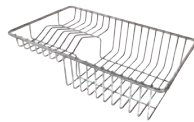

T2 *

Stainless steel
plate rack
21.4x37.9 cm
8100 303



Z2 *

Stainless steel
perforated tray
21.5x38 cm
8151 000

Also available in version **PVD**



Gun Metal
8151 006



Copper
8151 008



Gold
8151 009

1718 850 **B3 K7 K8 L4 N2 N3 O2 R2**
T1 T2 Z2

1717 850 **B3 K7 K8 L4 N2 N3 O2 R2**
T1 T2 Z2

1715 850 **B3 K7 K8 L4 N2 N3 O2 R2**
T1 T2 Z2

optional automatic waste fittings

1718 850 **PL PP PA PE PM**

1717 850 **PL PP PA PE PM**

1715 850 **PL PP PA PE PM**

See page 298

* only usable in combination with chopping board N3

1718 850

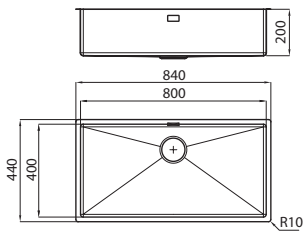

1717 850

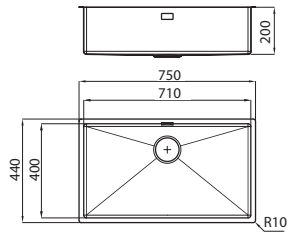

1715 850

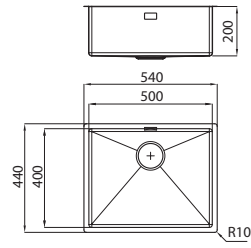

UNDERMOUNT
SINKS

Quadra
undermount



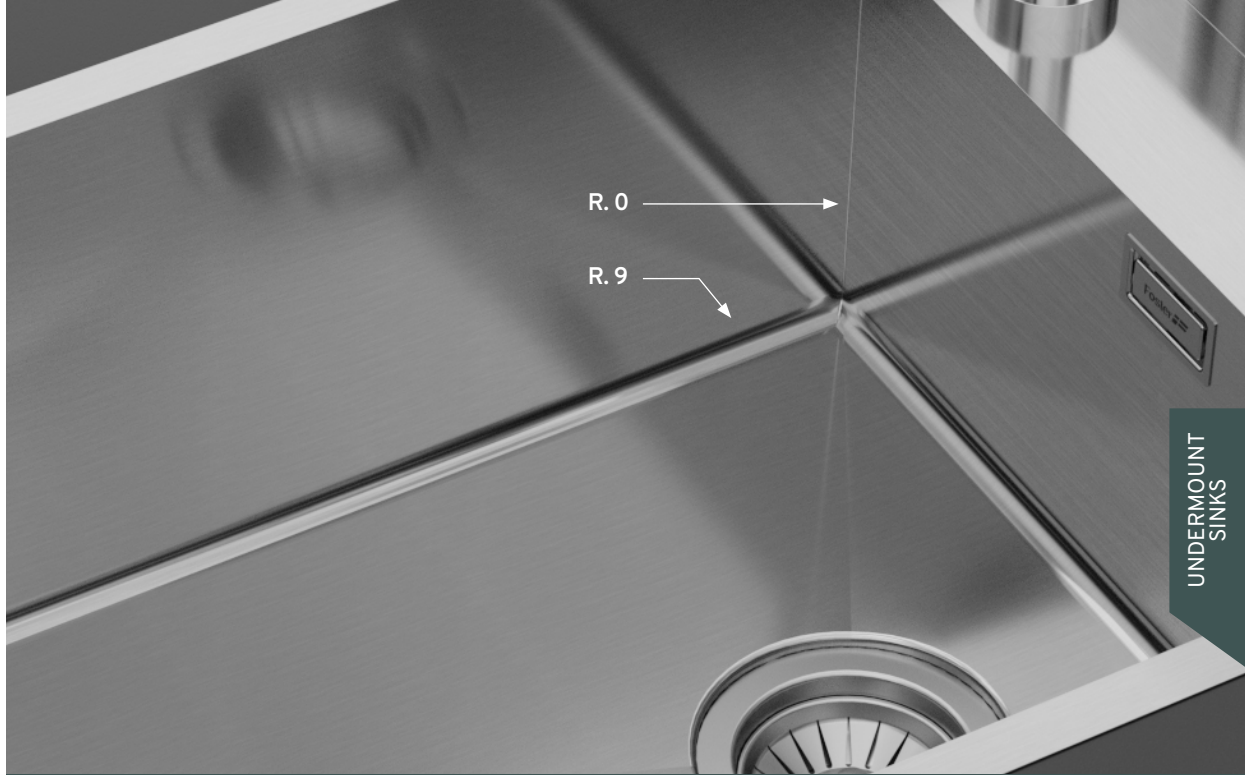

UNDERMOUNT
SINKS

The R9 radius on the bottom
facilitates cleaning operations

Quadra

undermount

Code

Version

Characteristics

Price

Cabinet 90

1218 850

ST

cut-out: 800 x 400



- Satin finish AISI 304 stainless steel
- Dimensions: **850 x 450** - 1 bowl: **800 x 400**
- 3/2" waste fitting

Accessories, technical drawing
and automatic waste fittings on page 250

Cabinet 80

1217 850

ST

cut-out: 710 x 400



- Satin finish AISI 304 stainless steel
- Dimensions: **760 x 450** - 1 bowl: **710 x 400**
- 3/2" waste fitting

Accessories, technical drawing
and automatic waste fittings on page 250

Cabinet 60

1215 850

ST

cut-out: 500 x 400



- Satin finish AISI 304 stainless steel
- Dimensions: **550 x 450** - 1 bowl: **500 x 400**
- 3/2" waste fitting

Accessories, technical drawing
and automatic waste fittings on page 250

Quadra undermount

Code

Version

Characteristics

Price

Cabinet 60

1214 850

ST

cut-out: 400 x 400



- Satin finish AISI 304 stainless steel
- Dimensions: **450 x 450** - 1 bowl: **400 x 400**
- 3½" waste fitting

Accessories, technical drawing
and automatic waste fittings on page 250

UNDERMOUNT
SINKS

Cabinet 90 **NEW**

1221 850

ST

cut-out: 800 x 400



- Satin finish AISI 304 stainless steel
- Dimensions: **840 x 440** - 2 bowls: **380 x 400**
- 3.5" waste fitting

Accessories, technical drawing
and automatic waste fittings on page 250

Quadra

accessories



B3

Black grid
39 x 42 cm
8100 617



K7

Iroko wood chopping board kit 42 x 31.7 cm with stainless steel colander
8644 044



K8 *

Graters kit with frame and food tray
8159 101

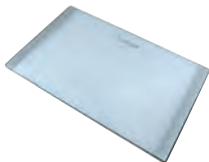

L4

Glass chopping board
23x41 cm
8631 300



N2

HDPE chopping board
27.2x42.5 cm
8657 001



N3

HDPE Twin chopping board 31.7x42.5
8644 101



O2

White bowl
27.2x41.4 cm
8153 100



R2

Stainless steel basket
34x40 cm
8611 000



R3

Stainless steel basket
40x40
8612 000

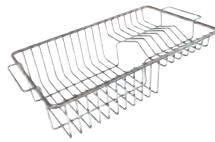

T1

Stainless steel plate rack
25x42.5 cm
8100 201

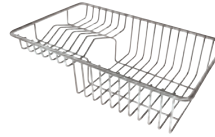

T2 *

Stainless steel plate rack
21.4x37.9 cm
8100 303



Z2 *

Stainless steel perforated tray
21.5x38 cm
8151 000

Also available in version PVD



Gun Metal
8151 006



Copper
8151 008



Gold
8151 009

1218 850 **B3 K7 K8 L4 N2 N3 O2 R2**
R3 T1 T2 Z2

1217 850 **B3 K7 K8 L4 N2 N3 O2 R2**
R3 T1 T2 Z2

1215 850 **B3 K7 K8 L4 N2 N3 O2 R2**
R3 T1 T2 Z2

1214 850 **K7 K8 L4 N2 N3 O2 R2 R3**
T1 T2 Z2

1221 850 **K7 K8 L4 N2 N3 O2 R2 R3**
T1 T2 Z2

optional automatic waste fittings

1218 850 **PL PP PA PM**

1217 850 **PL PP PA PM**

1215 850 **PL PP PA PM**

1214 850 **PL PP PA PM**

1221 850 **PL PP PA PM**

See page 298

* only usable in combination with chopping board N3

1218 850

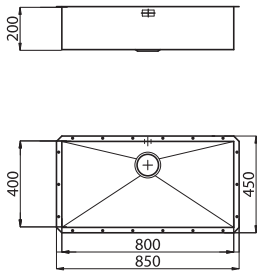

1217 850

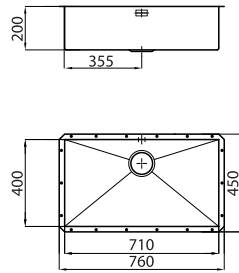

1215 850

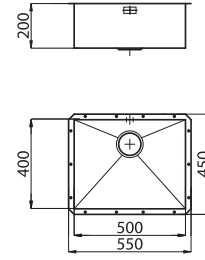

1214 850

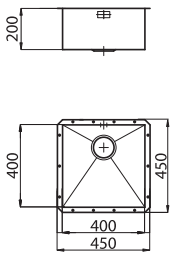

1221 850 **NEW**

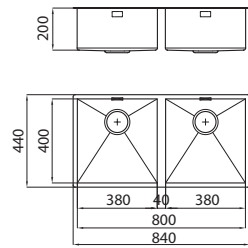

Circolari NEW undermount

Thick
sink

Impressive
concentric
polishing



Cabinet 60

Code	Version	Characteristics	Price
1130 860	ST	cut-out: Ø 380	



- Satin finish AISI 304 stainless steel
- Dimensions: Ø 425 - 1 bowl: Ø 380
- 3½" waste fitting

• Also available
in version PVD

Gun Metal
1130 866

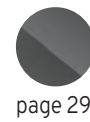

Copper
1130 868

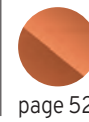

Gold
1130 869

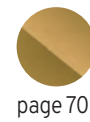

accessories



P1

Chopping board
41.4 x 32 cm
in Iroko wood
8648 002

optional automatic waste fittings

PR PQ PC

See page 298

technical drawing

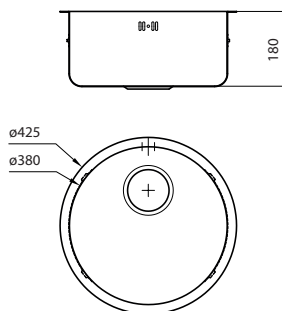



UNDERMOUNT
SINKS

S4001 | undermount bowls R12



S4001 | undermount bowls R12

Code

Version

Characteristics

Price

Cabinet 90

3358 850

ST

cut-out: 800 x 400 R12



- Satin finish AISI 304 stainless steel
- Dimensions: **840 x 440** - 1 bowl: **800 x 400**
- Space 3½" waste fitting

Accessories, technical drawing
and automatic waste fittings on page 258

Cabinet 80

3357 850

ST

cut-out: 710 x 400 R12



- Satin finish AISI 304 stainless steel
- Dimensions: **750 x 440** - 1 bowl: **710 x 400**
- Space 3½" waste fitting

Accessories, technical drawing
and automatic waste fittings on page 258

Cabinet 80

3352 850

ST

cut-out: 710 x 400 R12



- Satin finish AISI 304 stainless steel
- Dimensions: **750 x 440** - 2 bowls: **340 x 400**
- Space 3½" waste fitting

Accessories, technical drawing
and automatic waste fittings on page 258

Cabinet 60

3355 850

ST

cut-out: 500 x 400 R12



- Satin finish AISI 304 stainless steel
- Dimensions: **540 x 440** - 1 bowl: **500 x 400**
- Space 3½" waste fitting

Accessories, technical drawing
and automatic waste fittings on page 258

Cabinet 60

3356 850

ST

cut-out: 400 x 400 R12



- Satin finish AISI 304 stainless steel
- Dimensions: **440 x 440** - 1 bowl: **400 x 400**
- Space 3½" waste fitting

Accessories, technical drawing
and automatic waste fittings on page 258

Cabinet 45

3353 850

ST

cut-out: 340 x 400 R12



- Satin finish AISI 304 stainless steel
- Dimensions: **380 x 440** - 1 bowl: **340 x 400**
- Space 3½" waste fitting

Accessories, technical drawing
and automatic waste fittings on page 258

S4001 | undermount bowls R12

Code

Version

Characteristics

Price

Cabinet 75

NEW

3138 850

ST

cut-out: 665 x 375 R12



- Satin finish AISI 304 stainless steel
- Dimensions: **695 x 405** - 1 bowl: **665 x 375**
- Space 3½" waste fitting

Accessories, technical drawing
and automatic waste fittings on page 258

UNDERMOUNT
SINKS

S4001 | undermount bowls

accessories



B3
Black grid
39 x 42 cm
8100 617



B6
Black grid
38 x 38 cm
8100 651



B7
Black grid
38 x 48 cm
8100 652



B8
Black grid
38 x 69 cm
8100 653



K7
Iroko wood chop-
ping board kit
42 x 31.7 cm
with stainless steel
colander
8644 044

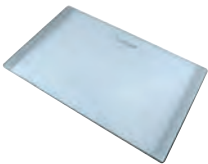

L4
Glass chopping board
23x41 cm
8631 300



N2
HDPE chopping board
27.2x42.5 cm
8657 001



N3
HDPE Twin chopping
board 31.7x42.5
8644 101



O2
White bowl
27.2x41.4 cm
8153 100



K8 *
Graters kit with frame
and food tray
8159 101



R2
Stainless steel basket
34x40 cm
8611 000



R3
Stainless steel basket
40x40
8612 000



T1
Stainless steel plate
rack 25x42.5 cm
8100 201

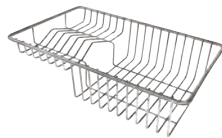

T2 *
Stainless steel plate
rack 21.4x37.9 cm
8100 303



T8
Stainless steel
plate rack
21.4x37.2 cm
8100 306



Z2 *
Stainless steel
perforated tray
21.5x38 cm
8151 000

Also available in version **PVD**



Gun Metal 8151 006
Copper 8151 008
Gold 8151 009

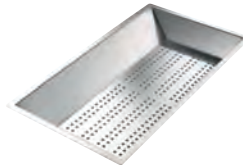

Z3
Stainless steel
perforated tray
21.5x40 cm
8156 000



P2
Chopping board
39.5 x 22.5 cm
in Iroko wood
8642 004

* only usable in combination with chopping board N3

3358 850 **B3 K7 L4 N2 N3 O2 K8 R2**

R3 T1 T2 Z2

3357 850 **K7 L4 N2 N3 O2 K8 R2 R3**

T1 T2 Z2

3352 850 **K7 L4 N2 N3 O2 K8 R2 R3**

T1 T2 Z2

3355 850 **B3 B7 K7 L4 N2 N3 O2 K8**

R2 R3 T1 T2 Z2

3356 850 **B3 K7 L4 N2 N3 O2 K8 R2**

R3 T1 T2 Z2

3353 850 **K7 L4 N2 N3 O2 K8 R2 R3**

T1 T2 Z2

3138 850 **Z3 O2 R2 T8 P2**

optional automatic waste fittings

3138 850 **PL PP PA PE PM**

3358 850 **PL PP PA PE PM**

3357 850 **PL PP PA PE PM**

3352 850 **PL PP PA PE PM**

3355 850 **PL PP PA PE PM**

3356 850 **PL PP PA PE PM**

3353 850 **PL PP PA PE PM**

See page 298

3358 850

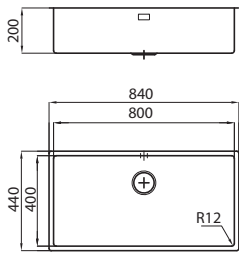

3357 850

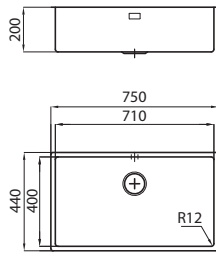

3352 850

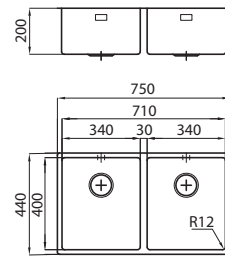

3355 850

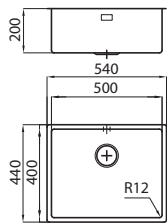

3356 850

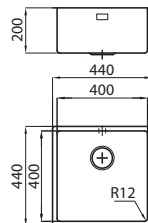

3353 850

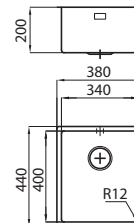

3138 850

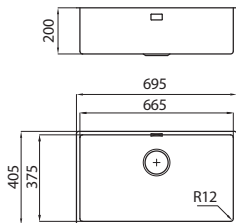

Series 45 | undermount bowls R12

Code

Version

Characteristics

Price

Cabinet 90

3143 850

ST

cut-out: 800 x 450 R12



45 cm

- Satin finish AISI 304 stainless steel
- Dimensions: **830 x 480** - 1 bowl: **800 x 450**
- 3/2" waste fitting

Accessories and technical drawing on page 261

Cabinet 60

3141 850

ST

cut-out: 500 x 450 R12



45 cm

- Satin finish AISI 304 stainless steel
- Dimensions: **530 x 480** - 1 bowl: **500 x 450**
- 3/2" waste fitting

Accessories and technical drawing on page 261

Cabinet 60

3139 850

ST

cut-out: 400 x 450 R12



45 cm

- Satin finish AISI 304 stainless steel
- Dimensions: **430 x 480** - 1 bowl: **400 x 450**
- 3/2" waste fitting

Accessories and technical drawing on page 261

Series 45 | accessories

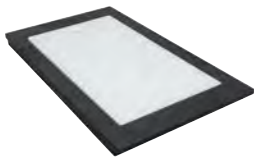

K1
Support outline frame kit 28x47.4 multi-accessory with HDPE chopping board 8100 627



O2
White bowl 27.2x41.4 cm 8153 100



K8 *
Graters kit with frame and food tray 8159 101



R3
Stainless steel basket 40x40 - 8612 000

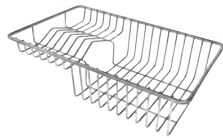

T2 *
Stainless steel plate rack 21.4x37.9 cm 8100 303



Z2 *
Stainless steel plate rack 21.5x38 cm 8151 000

Also available in version **PVD**



Gun Metal
8151 006



Copper
8151 008



Gold
8151 009

* only usable in combination with kit K1

3143 850 **K1 O2 K8 R3 T2 Z2**

3141 850 **K1 O2 K8 R3 T2 Z2**

3139 850 **K1 O2 K8 R3 T2 Z2**

optional automatic waste fittings

3143 850 **PA PE PM PL PP**

3141 850 **PA PE PM PL PP**

3139 850 **PA PE PM PL PP**

See page 298

Series 45 | technical drawings

3143 850

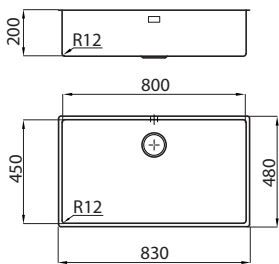

3141 850

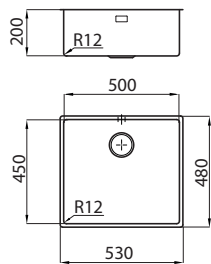

3139 850

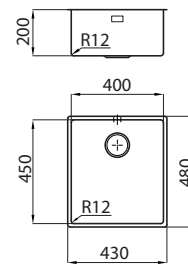

Series 35 | undermount bowls R12

Code

Version

Characteristics

Price

Cabinet 90

3137 850

ST

cut-out: 750 x 350 R12



- Satin finish AISI 304 stainless steel
- Dimensions: **780 x 380** - 1 bowl: **750 x 350**
- 3/2" waste fitting

Accessories and technical drawing on page 263

Cabinet 60

3135 850

ST

cut-out: 500 x 350 R12



- Satin finish AISI 304 stainless steel
- Dimensions: **530 x 380** - 1 bowl: **500 x 350**
- 3/2" waste fitting

Accessories and technical drawing on page 263

Cabinet 45

3136 850

ST

cut-out: 365 x 350 R12



- Satin finish AISI 304 stainless steel
- Dimensions: **395 x 380** - 1 bowl: **365 x 350**
- 3/2" waste fitting

Accessories and technical drawing on page 263

Serie 35 | accessories



P3

Chopping board
26x36.6 cm
8643 117



T6

Stainless steel plate
rack 23x37.5 cm
8100 305



O2

White bowl
27.2x41.4 cm
8153 100



B4

Black grid
36.8 x 34.2 cm
8100 618

3137 850 **P3 T6 O2 B4**

3135 850 **P3 T6 O2 B4**

3136 850 **P3 T6 O2**

optional automatic waste fittings

3137 850 **PA PE PM PL PP**

3135 850 **PA PE PM PL PP**

3136 850 **PA PE PM PL PP**

See page 298

UNDERMOUNT
SINKS

Series 35 | technical drawings

3137 850

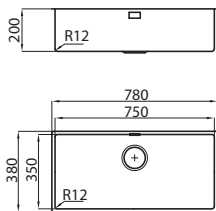

3135 850

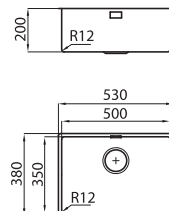

3136 850

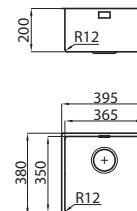

KE | R15
undermount



KE | R15

undermount

Code

Version

Characteristics

Price

Cabinet 100

2207 850

ST

cut-out: 880 x 400 R15



- Satin finish AISI 304 stainless steel
- Dimensions: **930 x 450** - 2 bowls: **450 x 400 + 400 x 400**
- 3/2" waste fitting

Accessories, technical drawing and automatic waste fittings on page 270

UNDERMOUNT
SINKS

Cabinet 90

2206 850

ST

cut-out: 770 x 400 R15



- Satin finish AISI 304 stainless steel
- Dimensions: **820 x 450** - 2 bowls: **400 x 400 + 340 x 400**
- 3/2" waste fitting

Accessories, technical drawing and automatic waste fittings on page 270

Cabinet 90

2205 850

ST

cut-out: 750 x 400 R15



- Satin finish AISI 304 stainless steel
- Dimensions: **800 x 450** - 2 bowls: **450 x 400 + 270 x 400**
- 3/2" waste fitting

Accessories, technical drawing and automatic waste fittings on page 270

KE | R15

undermount

Code

Version

Characteristics

Price

Cabinet 80

2204 851 rh
2204 852 lh

ST

cut-out: 710 x 400 R15



- Satin finish AISI 304 stainless steel
- Dimensions: **760 x 450** - 2 bowls: **500 x 400 + 180 x 400**
- 3/2" waste fitting

Accessories, technical drawing and automatic waste fittings on page 270

Cabinet 80

2203 850

ST

cut-out: 710 x 400 R15



- Satin finish AISI 304 stainless steel
- Dimensions: **760 x 450** - 2 bowls: **340 x 400**
- 3/2" waste fitting

Accessories, technical drawing and automatic waste fittings on page 270

Cabinet 80

2202 851 rh
2202 852 lh

ST

cut-out: 610 x 400 R15



- Satin finish AISI 304 stainless steel
- Dimensions: **660 x 450** - 2 bowls: **400 x 400 + 180 x 400**
- 3/2" waste fitting

Accessories, technical drawing and automatic waste fittings on page 270

KE | R15

undermount

Code | Version | Characteristics | Price

Cabinet 80

2201 851 rh  ST cut-out: 545 x 400 R15
2201 852 lh



- Satin finish AISI 304 stainless steel
- Dimensions: **585 x 440** - 2 bowls: **340 x 400 + 180 x 400**
- 3½" waste fitting

Accessories, technical drawing and automatic waste fittings on page 270





UNDERMOUNT SINKS

Cabinet 80

2157 850  ST cut-out: 710 x 400 R15



- Satin finish AISI 304 stainless steel
- Dimensions: **750 x 440** - 1 bowl: **710 x 400**
- 3½" waste fitting
- Also available in version **Vintage, PVD** and **PVD Vintage**

Vintage inox 2157 880	Gun Metal 2157 856	Copper 2157 858	Gold 2157 859	Brandy 2157 855
				 NEW
	Vintage 2157 886 page 30	Vintage 2157 888 page 50	Vintage 2157 889 page 68	page 85





Accessories, technical drawing and automatic waste fittings on page 270

Cabinet 60

2155 850  ST cut-out: 500 x 400 R15



- Satin finish AISI 304 stainless steel
- Dimensions: **540 x 440** - 1 bowl: **500 x 400**
- 3½" waste fitting
- Also available in version **Vintage, PVD** and **PVD Vintage**

Vintage inox 2155 880	Gun Metal 2155 856	Copper 2155 858	Gold 2155 859	Brandy 2155 855
				 NEW
	Vintage 2155 886 page 31	Vintage 2155 888 page 51	Vintage 2155 889 page 69	page 85

Accessories, technical drawing and automatic waste fittings on page 270

KE | R15

undermount

Code	Version	Characteristics	Price
------	---------	-----------------	-------

Cabinet 60

2154 850	 ST	cut-out: 450 x 400 R15	
-----------------	---	------------------------	--



- Satin finish AISI 304 stainless steel
- Dimensions: **490 x 440** - 1 bowl: **450 x 400**
- 3/2" waste fitting

• Also available in version **PVD**

Gun Metal
2154 856



page 31

Accessories, technical drawing and automatic waste fittings on page 270

Cabinet 60

2156 850	 ST	cut-out: 400 x 400 R15	
-----------------	---	------------------------	--



- Satin finish AISI 304 stainless steel
- Dimensions: **440 x 440** - 1 bowl: **400 x 400**
- 3/2" waste fitting

• Also available in version **Vintage, PVD** and **PVD Vintage**

Vintage
inox
2156 880



Gun Metal
2156 856

Vintage
2156 886



page 32

Copper
2156 858

Vintage
2156 888



page 51

Gold
2156 859

Vintage
2156 889



page 69

Accessories, technical drawing and automatic waste fittings on page 270

Cabinet 45

2153 850	 ST	cut-out: 340 x 400 R15	
-----------------	---	------------------------	--



- Satin finish AISI 304 stainless steel
- Dimensions: **380 x 440** - 1 bowl: **340 x 400**
- 3/2" waste fitting

• Also available in version **PVD**

Gun Metal
2153 856



page 32

Accessories, technical drawing and automatic waste fittings on page 270

KE | R15

undermount

Code	Version	Characteristics	Price
------	---------	-----------------	-------

Cabinet 40

2152 850	 ST	cut-out: 270 x 400 R15	
-----------------	--	------------------------	--



- Satin finish AISI 304 stainless steel
- Dimensions: **310 x 440** - 1 bowl: **270 x 400**
- 3/2" waste fitting

Accessories, technical drawing and automatic waste fittings on page 270

UNDERMOUNT
SINKS

Cabinet 30

2151 850	 ST	cut-out: 180 x 400 R15	
-----------------	--	------------------------	--



- Satin finish AISI 304 stainless steel
- Dimensions: **222 x 442** - 1 bowl: **180 x 400**
- 3/2" waste fitting

- Also available in version **PVD**





Gun Metal
2151 856



page 33

Accessories, technical drawing and automatic waste fittings on page 270

-  **B3**
Black grid
39 x 42 cm
8100 617
-  **B6**
Black grid
38 x 38 cm
8100 651
-  **B7**
Black grid
38 x 48 cm
8100 652
-  **B8**
Black grid
38 x 69 cm
8100 653
-  **L4**
Glass chopping board
23x41 cm
8631 300
-  **N2**
HDPE chopping board
27.2x42.5 cm
8657 001
-  **N3**
HDPE Twin chopping board
31.7x42.5 cm
8644 101
-  **O2**
White bowl
27.2x41.4 cm
8153 100
-  **K7**
Iroko wood chopping board kit
42 x 31.7 cm with
stainless steel
colander
8644 044
-  **K8** *
Graters kit with
frame and food tray
8159 101

-  **R2**
Stainless steel basket
34x40 cm
8611 000
-  **R3**
Stainless steel basket
40x40 cm
8612 000
-  **T1**
Stainless steel plate
rack 25x42.5 cm
8100 201
-  **T2** *
Stainless steel plate
rack 21.4x37.9 cm
8100 303
-  **Z2** *
Stainless steel
perforated tray
21.5x38 cm
8151 000

Also available in version PVD

- | | | |
|---|---|---|
|  |  |  |
| Gun Metal
8151 006 | Copper
8151 008 | Gold
8151 009 |

- 2207 850 **B3 L4 N2 N3 O2 K7 K8 R2**
R3 T1 T2 Z2 B6

- 2206 850 **B3 L4 N2 N3 O2 K7 K8 R2**
R3 T1 T2 Z2 B6

- 2205 850 **L4 N2 N3 O2 K7 K8 R2 R3**
T1 T2 Z2 B3

- 2204 851 **B3 L4 N2 N3 O2 K7 K8 R2**
2204 852 **R3 T1 T2 Z2 B7**

- 2203 850 **L4 N2 N3 O2 K7 K8 R2 R3**
T1 T2 Z2

- 2202 851 **L4 N2 N3 O2 K7 K8 R2 R3**
2202 852 **T1 T2 Z2 B3 B6**

- 2201 851 **L4 N2 N3 O2 K7 K8 R2 R3**
2201 852 **T1 T2 Z2**

- 2157 850 **B3 B8 L4 N2 N3 O2 K7 K8**
R2 R3 T1 T2 Z2

- 2155 850 **B3 B7 L4 N2 N3 O2 K7 K8**
R2 R3 T1 T2 Z2

- 2154 850 **B3 L4 N2 N3 O2 K7 K8 R2**
R3 T1 T2 Z2

- 2156 850 **B3 L4 N2 N3 O2 K7 K8 R2**
R3 T1 T2 Z2 B6

- 2153 850 **L4 N2 N3 O2 K7 K8 R2 R3**
T1 T2 Z2

- 2152 850 **L4 N2 T1**

optional automatic waste fittings

on all models in the line

- PA PE PM PL PP**

See page 298

* only usable in combination with chopping board N3

2207 850

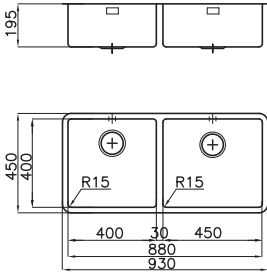

2206 850

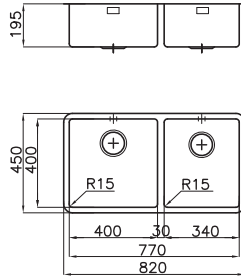

2205 850

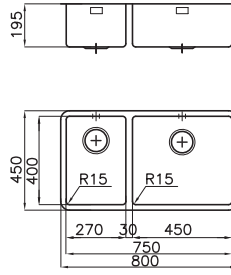

2204 851 rh | 2204 852 lh

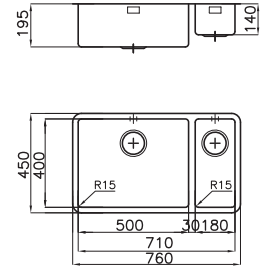

2203 850

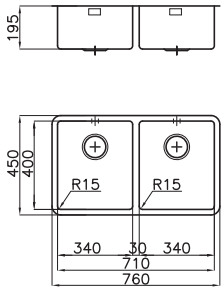

2202 851 rh | 2202 852 lh

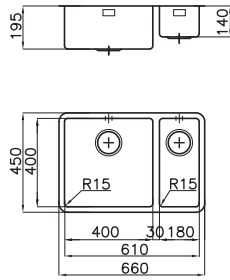

2201 851 rh | 2201 852 lh

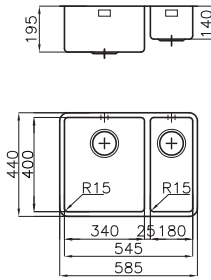

2157 850

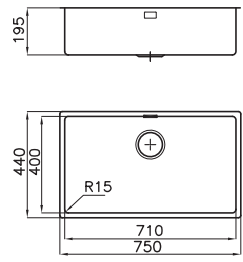

2155 850

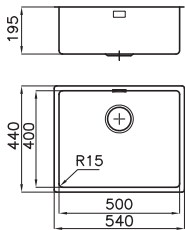

2154 850

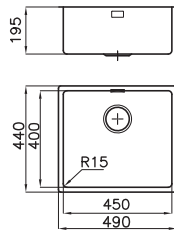

2156 850

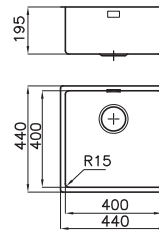

2153 850

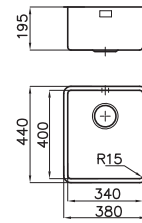

2152 850

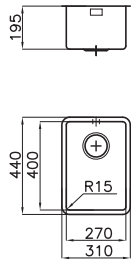

2151 850

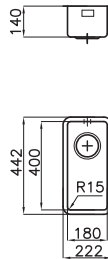

KE | R15 easy to fix
undermount

NEW

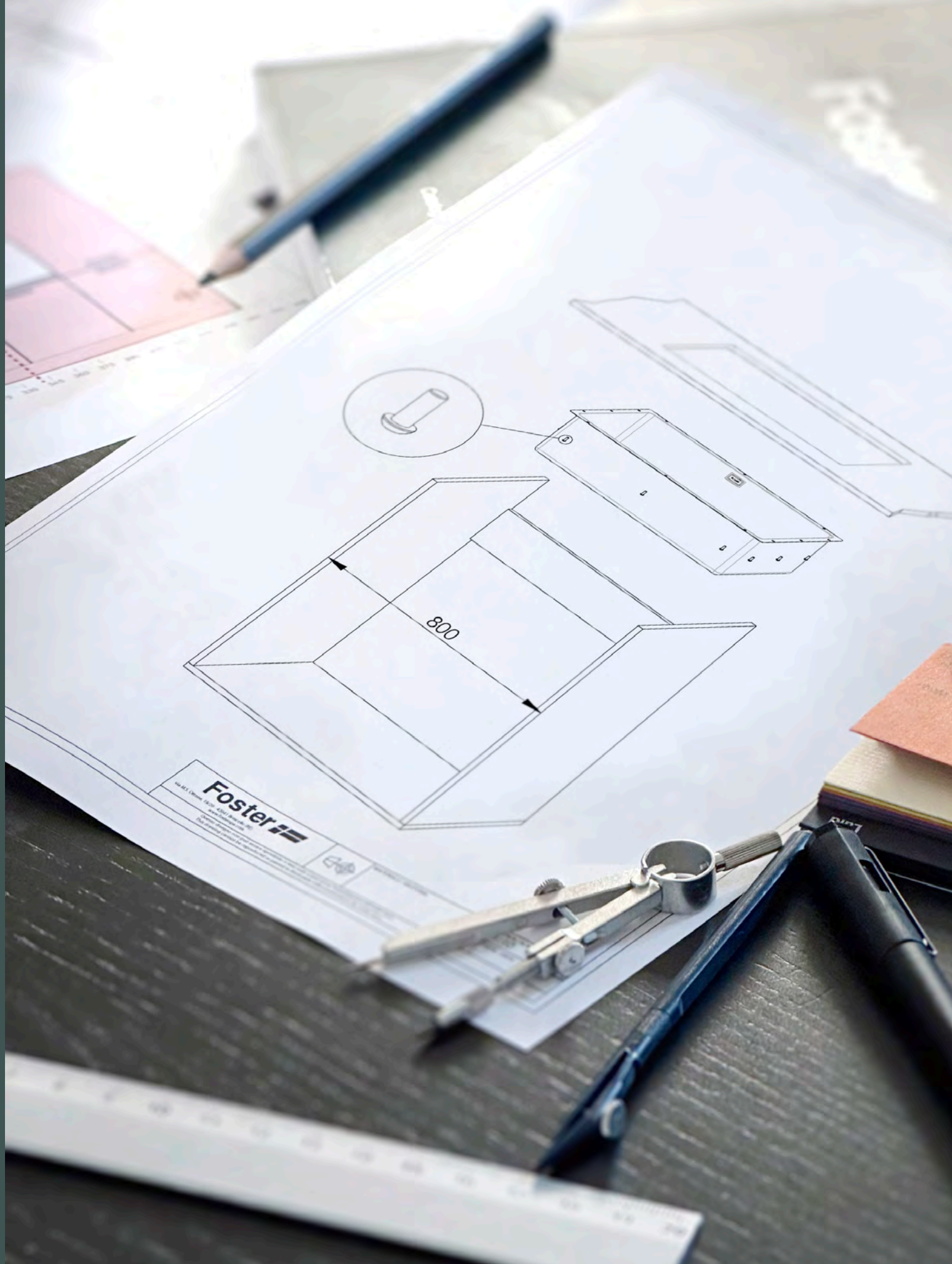

Foster

MAX 1000 mm (39 3/8")

MAX 450 mm (17 3/4")

MAX 150 mm (5 7/8")

MAX 100 mm (3 7/8")

MAX 50 mm (1 7/8")

MAX 25 mm (1")

MAX 12 mm (1/2")

MAX 6 mm (1/4")

MAX 3 mm (1/8")

MAX 1.5 mm (1/16")

MAX 0.75 mm (1/32")

MAX 0.375 mm (1/64")

MAX 0.1875 mm (1/128")

MAX 0.09375 mm (1/256")

MAX 0.046875 mm (1/512")

MAX 0.0234375 mm (1/1024")

MAX 0.01171875 mm (1/2048")

MAX 0.005859375 mm (1/4096")

MAX 0.0029296875 mm (1/8192")

MAX 0.00146484375 mm (1/16384")

MAX 0.000732421875 mm (1/32768")

MAX 0.0003662109375 mm (1/65536")

MAX 0.00018310546875 mm (1/131072")

MAX 0.000091552734375 mm (1/262144")

MAX 0.0000457763671875 mm (1/524288")

MAX 0.00002288818359375 mm (1/1048576")

MAX 0.000011444091796875 mm (1/2097152")

MAX 0.0000057220458984375 mm (1/4194304")

MAX 0.00000286102294921875 mm (1/8388608")

MAX 0.000001430511474609375 mm (1/16777216")

MAX 0.0000007152557373046875 mm (1/33554432")

MAX 0.00000035762786865234375 mm (1/67108864")

MAX 0.000000178813934326171875 mm (1/134217728")

MAX 0.0000000894069671630859375 mm (1/268435456")

MAX 0.00000004470348358154296875 mm (1/536870912")



KE R15 easy to fix undermount



Code

Version

Characteristics

Price

Cabinet 80

2157 840



cut-out: 710 x 400 R15



- Satin finish AISI 304 stainless steel
- Dimensions: **750 x 440** - 1 bowl: **710 x 400**
- 3/2" waste fitting

Accessories, technical drawing and automatic waste fittings on page 274

UNDERMOUNT
SINKS

Cabinet 60

2155 840



cut-out: 500 x 400 R15



- Satin finish AISI 304 stainless steel
- Dimensions: **540 x 440** - 1 bowl: **500 x 400**
- 3/2" waste fitting

Accessories, technical drawing and automatic waste fittings on page 274

The drilled edge

allows installation without the use of brackets.
The cabinet side panels do not need to be altered
to accommodate the fixing brackets.

KE | R15 easy to fix

accessories

- 

B3
Black grid
39 x 42 cm
8100 617
- 

B7
Black grid
38 x 48 cm
8100 652
- 

B8
Black grid
38 x 69 cm
8100 653
- 

L4
Glass chopping board
23x41 cm
8631 300
- 

N2
HDPE chopping board
27.2x42.5 cm
8657 001
- 

N3
HDPE Twin chopping
board 31.7x42.5
8644 101
- 

O2
White bowl
27.2x41.4 cm
8153 100
- 

K7
Iroko wood chopping
board kit 42 x 31.7 cm
with
stainless steel
colander
8644 044
- 

K8 *
Graters kit with
frame and food tray
8159 101
- 

R2
Stainless steel basket
34x40 cm
8611 000

- 

R3
Stainless steel basket
40x40
8612 000
- 

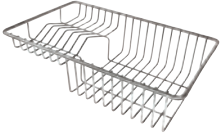
T1
Stainless steel plate
rack 25x42.5 cm
8100 201
- 

T2 *
Stainless steel plate
rack 21.4x37.9 cm
8100 303
- 

Z2 *
Stainless steel
perforated tray
21.5x38 cm
8151 000

Also available in version PVD

- | | | |
|---|---|---|
|  |  |  |
| Gun Metal
8151 006 | Copper
8151 008 | Gold
8151 009 |

2157 840 **B3 B8 L4 N2 N3 O2 K7 K8**
R2 R3 T1 T2 Z2

2155 850 **B3 B7 L4 N2 N3 O2 K7 K8**
R2 R3 T1 T2 Z2

optional automatic waste fittings

2157 840 **PA PE PM PL PP**

2155 850 **PA PE PM PL PP**

See page 298

* only usable in combination with chopping board N3

2157 840

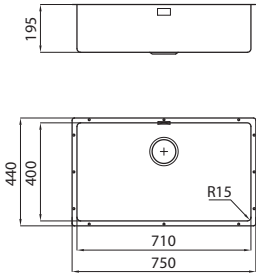

2155 840

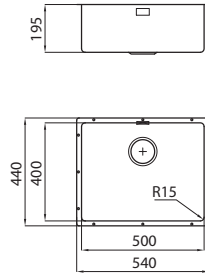

Easy to fix

Thanks to the drilled edge, the bowl can be installed without using traditional brackets.



S400 | R30

undermount



Cabinet 80



Accessories, technical drawing and automatic waste fittings on page 277

Code

1870 850

Version

ST

Characteristics

cut-out: 730 x 400 R30

Price

- Satin finish AISI 304 stainless steel
- Dimensions: **756 x 426** - 1 bowl: **730 x 400**
- 3½" waste fitting

Cabinet 60



Accessories, technical drawing and automatic waste fittings on page 277

1865 850

ST

cut-out: 530 x 400 R30

- Satin finish AISI 304 stainless steel
- Dimensions: **556 x 426** - 1 bowl: **530 x 400**
- 3½" waste fitting

S400

accessories



B3
Black grid
39 x 42 cm
8100 617



N2
HDPE chopping board
27.2x42.5 cm
8657 001



N3
HDPE Twin chopping board
31.7x42.5 cm
8644 101



O2
White bowl
27.2x41.4 cm
8153 100



K8 *
Graters kit with frame
and food tray
8159 101



R3
Stainless steel basket
40x40 - 8612 000



K7
Iroko wood chopping board kit
42 x 31.7 cm with
stainless steel
colander
8644 044



T1
Stainless steel plate
rack 25x42.5 cm
8100 201



T2 *
Stainless steel plate
rack 21.4x37.9 cm
8100 303



Z2 *
Stainless steel
perforated tray
21.5x38 cm
8151 000

Also available in version **PVD**



Gun Metal
8151 006



Copper
8151 008



Gold
8151 009

1870 850 **B3 N2 N3 O2 K8 R3 K7 T1**
T2 Z2

1865 850 **B3 N2 N3 O2 K8 R3 K7 T1**
T2 Z2

optional automatic waste fittings

1870 850 **PA PE PM PL PP**

1865 850 **PA PE PM PL PP**

See page 298

S400 technical drawings

1870 850

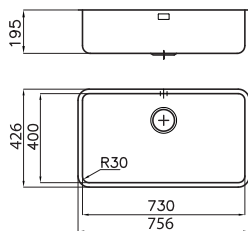

1865 850

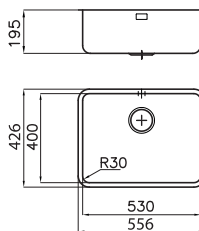

* utilizzabile solo in abbinamento al tagliere N3

Big Bowl undermount



Cabinet 60



Code

1811 050

Version

— **ST**

Characteristics

cut-out: 450 x 400 R95

Price

- Satin finish AISI 304 stainless steel
- Dimensions: **475 x 425** - 1 bowl: **450 x 400**
- 3½" waste fitting

Accessories, technical drawing and automatic waste fittings on page 279

Cabinet 30



1300 068

— **ST**

cut-out: 150 x 300 R50

- Satin finish AISI 304 stainless steel
- Dimensions: **170 x 320** - 1 bowl: **150 x 300**
- 3½" waste fitting

Accessories, technical drawing and automatic waste fittings on page 279

Big Bowl | accessories

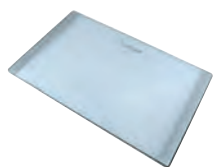

L4
Glass chopping board
23x41 cm
8631 300



N2
HDPE chopping board 27,2x42,5 cm
8657 001



R3
Stainless steel basket
40x40
8612 000



Z1
Stainless steel colander 17,3x32
8154 043

1811 050 **L4 N2 R3**

1300 068 **Z1**

optional automatic waste fittings

1811 050 **PR PQ PC**

1300 068 **PR PQ PC**

See page 298

UNDERMOUNT SINKS

Big Bowl | technical drawings

1811 050

1300 068

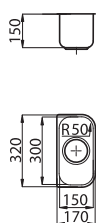
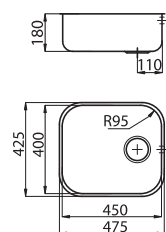

Tornado

undermount



Cabinet 80



Code	Version	Characteristics	Price
1679 860	— ST	cut-out: 750 x 460 R125	

- Satin finish AISI 304 stainless steel
- Dimensions: **816 x 524** - 1 bowl: **730 x 440**
- 3/2" automatic waste fitting

Accessories, technical drawing and automatic waste fittings on page 281

Tornado | accessories



P5

Chopping board
37x30 cm
8659 111



P4

Twin chopping board
37x46
8644 003



O2

White bowl
41.4x27.2 cm
8153 100



Z4

White colander
17x32 cm
8151 100



T *

Stainless steel plate
rack 25x35 cm
8100 154



T7

Stainless steel plate
rack 25x45 cm
8100 111

1679 860 **P5 P4 O2 Z4 T T7**

* only usable in combination with chopping board P4

UNDERMOUNT
SINKS

Tornado | technical drawings

1679 860

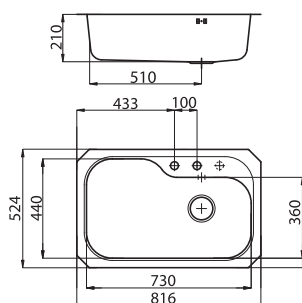

KS | R60
undermount



Cabinet 80



Code

1303 860

Version

ST

Characteristics

cut-out: 715 x 400 R60

Price

- Satin finish AISI 304 stainless steel
- Dimensions: **761 x 446** - 2 bowls: **340 x 400**
- 3/2" waste fitting

Accessories, technical drawing and automatic waste fittings on page 284

Cabinet 60

1850 850

ST

cut-out: 501 x 401 R60



- Satin finish AISI 304 stainless steel
- Dimensions: **539 x 436** - 1 bowl: **500 x 400**
- 3/2" waste fitting

Accessories, technical drawing and automatic waste fittings on page 284

KS | R60

undermount

Code	Version	Characteristics	Price
------	---------	-----------------	-------

Cabinet 60

1845 850	 ST	cut-out: 451 x 401 R60	
-----------------	--	------------------------	--



- Satin finish AISI 304 stainless steel
- Dimensions: **488 x 438** - 1 bowl: **450 x 400**
- 3/2" waste fitting

Accessories, technical drawing and automatic waste fittings on page 284

UNDERMOUNT
SINKS

Cabinet 60

1840 850	 ST	cut-out: 401 x 401 R60	
-----------------	--	------------------------	--



- Satin finish AISI 304 stainless steel
- Dimensions: **436 x 436** - 1 bowl: **400 x 400**
- 3/2" waste fitting

Accessories, technical drawing and automatic waste fittings on page 284

KS | accessories

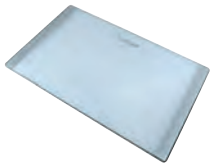

L4

Glass chopping board
23x41 cm
8631 300



N2

HDPE chopping board
27.2x42.5 cm
8657 001



O2

White bowl
27.2x41.4 cm
8153 100



R3

Stainless steel basket
40x40 - 8612 000



T1

Stainless steel plate
rack 25x42.5 cm
8100 201



K7

Chopping board kit
in Iroko wood
42 x 31.7 cm
with
stainless steel
colander
8644 044

1303 860 **L4 N2 O2 T1 K7**

1850 850 **L4 N2 O2 R3 T1 K7**

1845 850 **L4 N2 O2 R3 T1 K7**

1840 850 **L4 N2 O2 R3 T1 K7**

optional automatic waste fittings

1303 860 **PR PO PC**

1850 850 **PA PE PM PL PP**

1845 850 **PA PE PM PL PP**

1840 850 **PA PE PM PL PP**

See page 298

1303 860

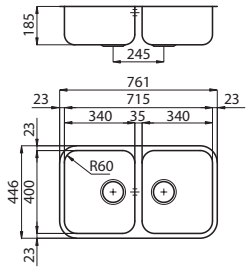

1850 850

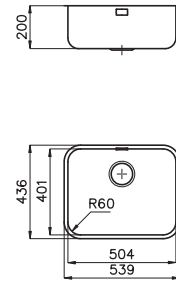

1845 850

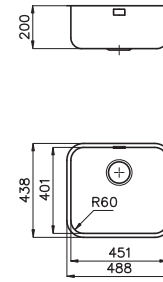

1840 850

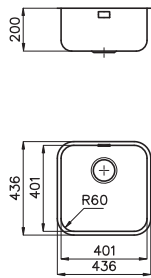

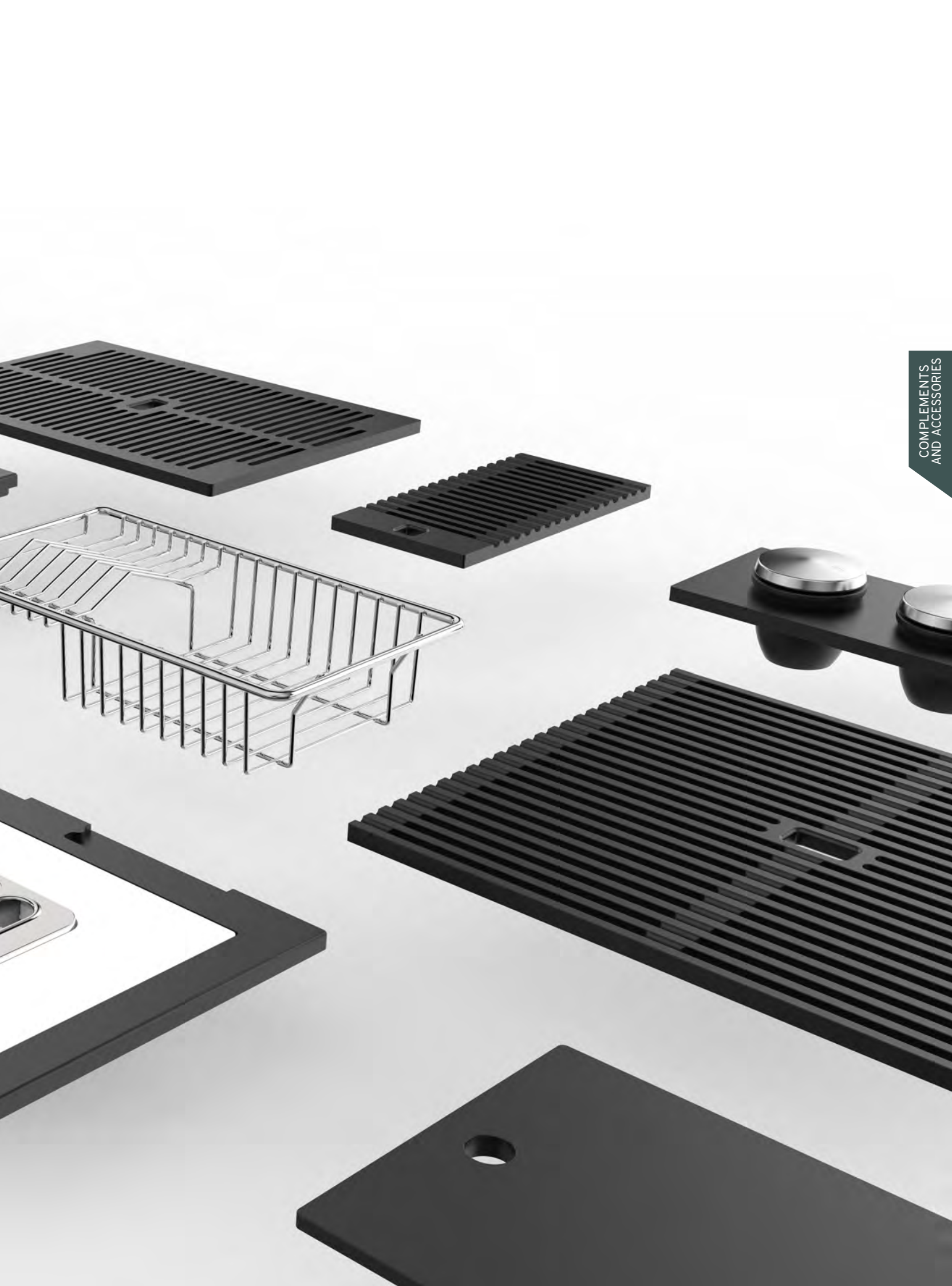

COMPLEMENTS
AND ACCESSORIES

Sink

A growing range of accessories is the main feature of our washing proposals. All models are complemented by **chopping boards, trays, plate racks** and **colanders** that embellish the aesthetics making the sink a truly functional workstation.

Accessories



Sink

Space and time, increasingly valuable elements in the kitchen. Which is why Foster has designed **integrated accessory systems that streamline your every move**, and don't take up much space when not in use.

Accessories - modular sets





A multi-purpose kit



Nature and Technology **Black Accessories**



Eco-friendly

- 100% recycled paper/cardboard impregnated with pigmented **Petrofree** resin obtained by squeezing cashew nut shells and from natural pigments.
- FSC certification



Non-toxic

- Certified for its suitability for contact with food.
- No residual Formaldehyde, no VOC.

Resistant

- To impacts, scratches, abrasion.
- To high temperature: withstands up to 180°C without affecting the surface.

Easy to clean

- Dishwasher-safe

Water repellent

Design focused

- Beautiful and light, with a texture pleasant to touch.

Multi-functional Black Grid



COMPLEMENTS
AND ACCESSORIES



Practical and sliding

They become a convenient
drainer



Rotating by 90°

They can be placed
on the bottom of the bowl to create a
**BOTTOM-SAVING
DRAINER**



Flow stopper

Thanks to the grooves between the slots
which prevent water from gushing onto
the worktop

Black grids and accessories

B1

Black grid
42.7 x 45 cm
8100 615



B2

Black grid
31 x 45 cm
8100 614



B3

Black grid
39 x 42 cm
8100 617



B4

Black grid
36.8 x 34.2 cm
8100 618



B5

Black grid
37.2 x 42.4 cm
8100 602



B6

Black grid
38 x 38 cm
8100 651



B7

Black grid
38 x 48 cm
8100 652



B8

Black grid
38 x 69 cm
8100 653



Black accessories

B9

Black grid
39.2x44.8 cm
8100 600



K1

Support outline
frame kit 28x47.4
multi-accessory
with HDPE chop-
ping board
8100 627

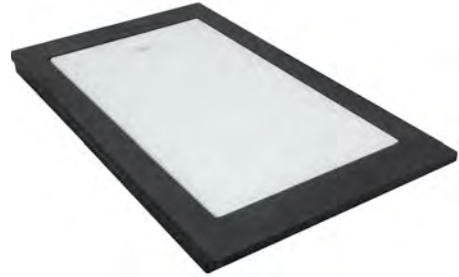

K2

Support outline
frame kit
multi-accessory
with Black
chopping board
44.8 x 28.9 cm
8100 037



X1

Stainless steel
perforated tray
12.6 x 12.1 cm
8151 001



X2

Knife holder
8542 655



To be used in combination with

K2 8100 037

K3

Spice holder
44.8 x 10 cm
8100 620



K4

Bottle
holder
44.8 x 14 cm
8100 621



X3

Knife
holder
8100 030



Can only be combined with

K4 8100 621

K5

3 stainless steel
bowls with lid
44.8 x 18 cm
8100 622



K6

Stainless steel
bowl with lid
and dish
44.8 x 28 cm
8100 628



Accessories

K7

Chopping board kit
in Iroko wood
42 x 31.7 cm
with
stainless steel
colander
8644 044



P1

Chopping board
41.4 x 32 cm
in Iroko wood
8648 002



P2

Chopping board
39.5 x 22.5 cm
in walnut wood
8642 004



P3

Chopping board
26x36.6 cm
in Iroko wood
8643 117



P4

Iroko wood
Twin chopping board
37x46 cm
8644 003



P5

Iroko wood
chopping board
37x30 cm
8659 111



P6

Walnut wood
chopping board
18x44.8 cm
8642 000



N2

HDPE
chopping board
27.2x42.5 cm
8657 001



N3

HDPE Twin
chopping board
31.7x42.5 cm
8644 101



K8

Graters kit with frame
and food collection
tray.
8159 101



To be used in combination with

N3 8644 101

K2 8100 037

K1 8100 627

T

Stainless steel
plate rack
25x35 cm
8100 154



T1

Stainless steel
plate rack
25x42.5 cm
8100 201

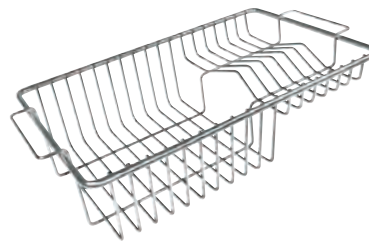

To be used in combination with

P4 8644 003

T2

Stainless steel
plate rack
21.4x37.9 cm
8100 303

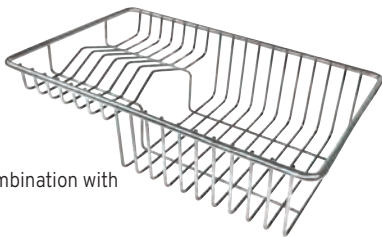

T3

Stainless steel
plate rack
28x40 cm
8100 280



To be used in combination with

N3 8644 101

K2 8100 037

K1 8100 627

T5

Stainless steel
plate rack
21.4x33.1 cm
8100 304

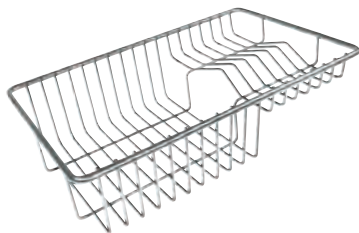

Accessori

T6

Stainless steel
plate rack
23x37.5 cm
8100 305

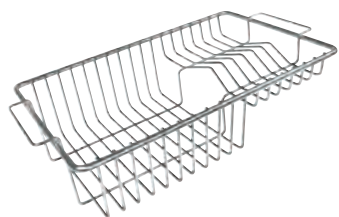

T8

Stainless steel
plate rack
21.4x37.2 cm
8100 306

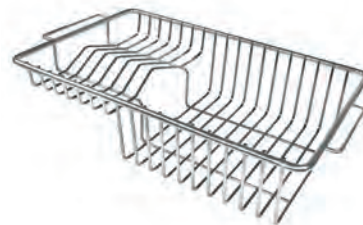

T7

Stainless steel
plate rack
25x45 cm
8100 111

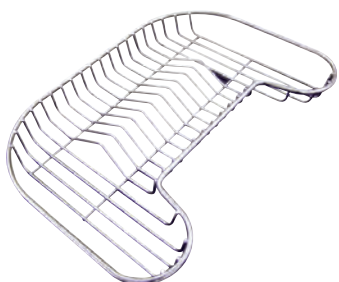

R1

Stainless steel
bowl-holder ring
37x45 cm
8100 112

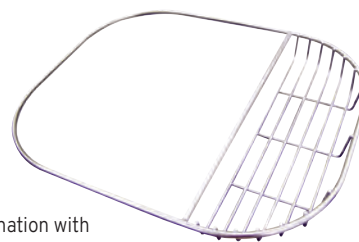

To be used in combination with

O1

8152 100

R2

Stainless steel
basket 34x40 cm
8611 000

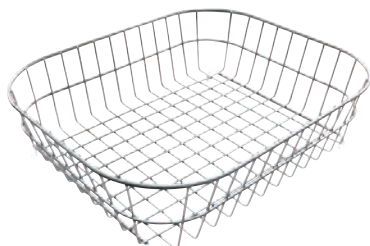

R3

Stainless steel basket
40x40 cm
8612 000



O1

White
bowl
36x30 cm
8152 100



O2

White bowl
41.4x27.2 cm
8153 100



Z4

White
colander
17x32 cm
8151 100



L4

Glass
chopping board
23x41 cm
8631 300

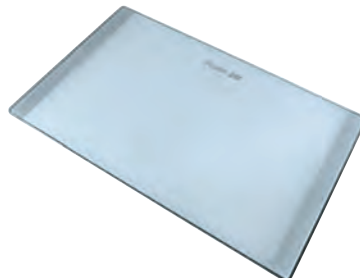

L5

Glass
chopping board
29x54 cm
8633 300



Z2

Stainless steel perforated tray 21.5x38 cm
8151 000

Also available
in version PVD



Gun Metal
8151 006

Z5



Copper
8151 008

Z6



Gold
8151 009

Z7



To be used in combination with

N3 8644 101

K2 8100 037

K1 8100 627

Z3

Stainless steel
perforated tray
21.5x40 cm
8156 000



Z1

Stainless steel
colander
17x32 cm
8154 043



Complements

Space **automatic waste fittings**

PL



8407117 Space Light **automatic waste fitting** with electric, lighted remote control and perimeter overflow. Double plug included: Space and "basket".

PP



8407116 Space Push **automatic waste fitting** with round push remote control and perimeter overflow. Double plug included: Space and "basket".

PO



8407120 Space Push Gun Metal **automatic waste fitting** with round push remote control and perimeter overflow. Double plug included: Space and "basket".

PB

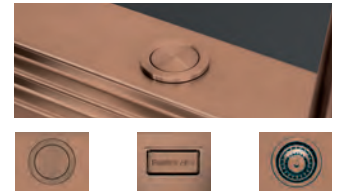

8407122 Space Push Copper **automatic waste fitting** with round push remote control and perimeter overflow. Double plug included: Stainless steel space and "basket".

PD



8407121 Space Push Gold **automatic waste fitting** with round push remote control and perimeter overflow. Double plug included: Stainless steel space and "basket".

PS



8407115 Space Milano **automatic waste fitting** with rotating round remote control and perimeter overflow. Double plug included: Space and "basket".

PA



8407108 Space **automatic waste fitting** with rotating square remote control and perimeter overflow. Double plug included: Space and "basket".

PE



8407109 Space **automatic waste fitting** with rotating round remote control and perimeter overflow. Double plug included: Space and "basket".

For installation on the worktop, all automatic waste fittings require a Ø 35 mm hole

Complements

Space automatic waste fittings' features



Designed for deep bowls, Space is very small. The drawing shows the side view of the Space system. The low height of the waste fitting and the design of the syphon optimise the under-sink area while leaving the space needed for waste collection requirements.



The Space plug collects food residues in the flexible neoprene basket underneath, which is very easy to clean.



The new Space Light and Push automatic waste fittings are even more convenient and enable the drain to be opened with a simple touch.

Automatic waste fittings

PM



8407 113 Automatic waste fitting with **rotating square** remote control and perimeter overflow



PG



8407 110 Gun Metal automatic waste fitting with rotating round remote control and perimeter overflow



PR



8407 100 Automatic waste fitting with rotating round remote control and overflow
8407 000 Automatic waste fitting with rotating round remote control and no overflow



PQ



8407 102 LIRA automatic waste fitting with rotating square remote control and overflow



PC



8407 103 LIRA automatic waste fitting with cubic push-pull remote control and overflow



Notes on the compatibility of automatic waste fittings

Automatic waste fittings are compatible with sinks that have at least a second hole (in addition to the one for the mixer tap).

For many sinks, this is not included as standard but can be requested when ordering. The sink drawings show the holes included as standard with a continuous line, the positions of any holes on request are indicated with a dotted line (see example below).

For undermount sinks, the possibility of installing an automatic waste fitting is always indicated because the hole can be made on the worktop. Always check the type of sink overflow so that a compatible automatic waste fitting is chosen.

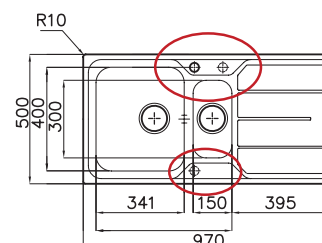







Second and third hole available









For installation on the worktop, all automatic waste fittings require a \varnothing 35 mm hole

Complements



Space 3½" waste fittings

	Code	Description	Price
	8403 008	Space waste fittings without overflow	
	8403 308	Space waste fittings with perimeter overflow	
	8669 012	Space stainless steel plug with silicone basket without hole: for auto waste fitting	
	8669 066	Space stainless steel plug with silicone basket without hole: for auto waste fitting GUN METAL	
	8669 068	Space stainless steel plug with silicone basket without hole: for auto waste fitting COPPER	
	8669 069	Space stainless steel plug with silicone basket without hole: for auto waste fitting GOLD	
	8669 011	Space stainless steel basket with hole for manual waste fitting	



3½" Waste fittings

	Code	Description	Price
	8403 000	Basket plug without overflow	
	8403 014	Satin finish basket plug without overflow	
	8403 303	Basket plug with perimeter overflow	
	8403 310	3.5" waste fitting overflow with overflow plate GUN METAL	
	8403 312	3.5" waste fitting overflow with overflow plate COPPER	
	8403 311	3.5" waste fitting overflow with overflow plate GOLD	
	8403 325	3.5" waste fitting overflow with overflow plate SUNSET	
	8403 300	Basket plug with overflow	
	8407 200	Uragano waste fitting with deep bowl (overflow with flexible hose)	

Lira 3½" Waste fittings

	Code	Description	Price
	8403 001	LIRA basket waste fitting without overflow	
	8403 301	LIRA basket waste fitting with overflow	

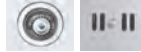
2" Waste fittings

	Code	Description	Price
	8401 000	2" waste fitting with handle plug with overflow	
	8402 000	Set of 2" waste fittings with handle plug 1 with overflow + 1 without overflow	

1¼" Waste fitting



	Code	Description	Price
	8404 000	1¼" waste fitting-overflow for drainer	

Miscellaneous



Code	Description	Price
8669 000	2" rubber handle plug	
8669 018	Basket plug for 3½" waste fitting	
8669 030	Basket plug with 3½" waste fitting GUN METAL	
8669 031	Basket plug with 3½" waste fitting COPPER	
8669 032	Basket plug with 3½" waste fitting GOLD	
8669 019	Basket plug with 3½" automatic waste fitting	
8669 033	Basket plug with 3½" automatic waste fitting GUN METAL	
8669 058	Basket plug with 3½" automatic waste fitting COPPER	
8669 059	Basket plug with 3½" automatic waste fitting GOLD	
8700 007	Sealant for built-in sinks with 4 and 8 mm edge	
8700 062	Sealant for built-in flush-mount sinks with lowered edge	
8700 080	Kit of 18 adapters for fixing hooks on 20 mm worktops *	
8669 009	STD overflow plate for perimeter overflow with logo with support	
8669 029	STD overflow plate for perimeter overflow with logo with support GUN METAL	
8669 028	STD overflow plate for perimeter overflow with logo with support COPPER	
8669 026	STD overflow plate for perimeter overflow with logo with support GOLD	
8669 008	Kit with long overflow plate for perimeter overflow with logo with support	
8401 001	15 cm waste fitting/overflow connection extension	
8660 000	Hole cover	

Complements

Syphons

	Code	Description	Price
	8410 000	1-way syphon with dishwasher connection	
	8415 000	2-way syphon with dishwasher connection	
	8435 000	2-way "Space" syphon with dishwasher connection	

Lira space-saving syphons

	Code Code	Description Description	Price Price
	8435 002	LIRA* 2-way "Space" syphon with dishwasher connection	
	8435 003	LIRA* 1-way inspectable syphon with dishwasher connection	

Floor syphons

Code	Description	Price
8411 000	1-way floor syphon with dishwasher connection	
8416 000	2-way floor syphon with dishwasher connection	

* it is advisable to combine LIRA syphons with waste fittings

COMPLEMENTS AND ACCESSORIES

Waste bins



Code | Price

8143 000

Split 2

Waste collection system with 2 pull-out compartments 12+12L
Cabinet min 30 cm
Coloured lids for easy recognition of compartments

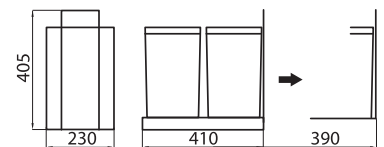

Code | Price

8119 000

Patty top

Waste bin with access from the top and bag removable from the top with stainless steel lid (capacity 13 litres).

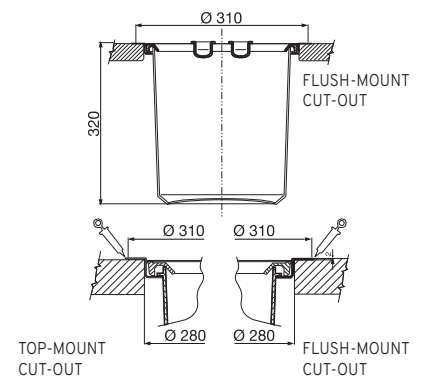



Complements

Socket holder columns



Code | Price

8000 011

Totem4 inox

Extractable socket holder tower

- 2 Schuko sockets
 - 1 ITA 10A-16A 3-pin socket
 - 1 USB socket for charging
- Including power cable
With satin finish stainless steel cap

Cut-out hole: $\varnothing 102$ mm - Worktop thickness: max 50 mm

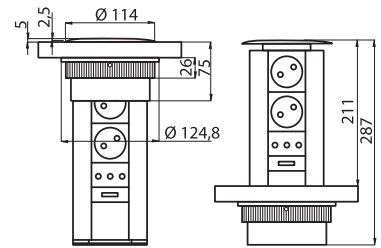

Code | Price

8000 012

Totem3

Extractable socket holder tower

- 2 Schuko sockets
 - 1 ITA 10A-16A 3-pin socket
- Including power cable
With grey painted cap

Cut-out hole: $\varnothing 102$ mm - Worktop thickness: max 50 mm

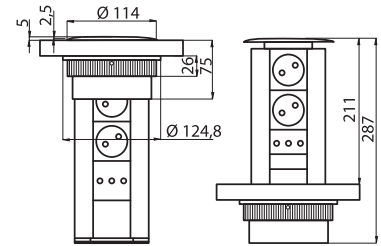

Code | Price

8000 014

Casper

Push extractable socket holder tower

- 2 Schuko sockets
- Including power cable

Cut-out hole: $\varnothing 80$ mm - Worktop thickness: max 60 mm

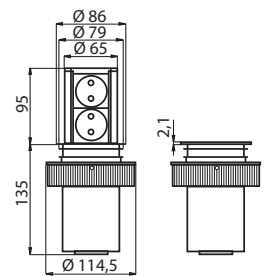

NEW

Code | Price

8000 018

Casper Black

Push extractable socket holder tower

- 2 Schuko sockets
- Including power cable

Cut-out hole: $\varnothing 80$ mm - Worktop thickness: max 60 mm

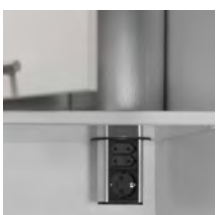
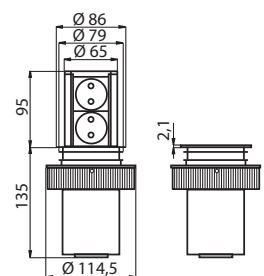

Code | Price

8000 214

Wall-mounted installation kit

Only for Casper towers. 8000 014, 8000 018

COMPLEMENTS
AND ACCESSORIES

Complements

Built-in socket holders



Code	Finish	Price
8000 010	Satin finish	
8000 117	Vintage	
8000 116	Gun Metal	
8000 119	Gold	
8000 118	Copper	



Reverse

Stainless steel push socket holder slot for built-in installation on worktops

- 2 Schuko sockets - 1 USB socket for charging

Built-in hole: 215x88 mm

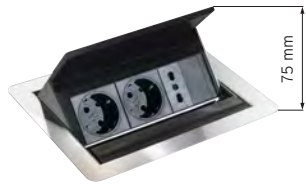
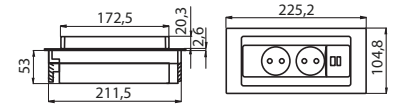

Code	Price
8000 113	

Filo3

Push socket holder slot for built-in installation on worktops

- 2 Schuko sockets
- 1 ITA 10A-16A 3-pin socket

Including power cable
Maximum worktop height 40 mm (for thicker and built-in flush-mount worktops, see the instruction manual).

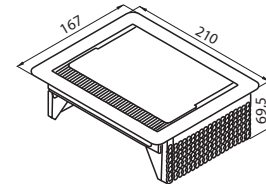

Code	Price
8000 015	

Cip

Socket holder to be built into the worktop

- 1 Schuko socket

Including power cable
Built-in hole: Ø 56 mm

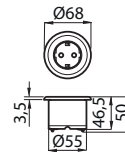

Accessories

- 8000 215 white cover kit
- 8000 115 steel grey cover kit
- 8000 315 black cover kit



Code	Price
8000 017	

Cip-Cip

Built-in socket holder slot with steel grey slide socket cover

- 2 Schuko sockets

Including power cable

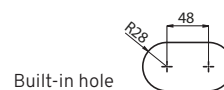
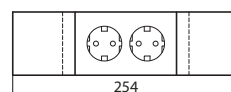
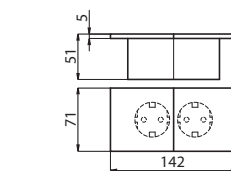

Built-in hole

Accessories

- 8000 217 white socket cover kit
- 8000 317 black socket cover kit



Complements



NEW

Code | Price

8000 028

Circle Black
Built-in socket holder slot with socket cover

- 2 Schuko sockets

Including power cable
Built-in hole: Ø 105 mm
Maximum worktop height 40 mm (for thicker and built-in flush-mount worktops, see the instruction manual).

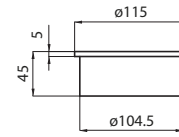

Steel cleaning products

Stainless steel products do not need special maintenance; however, some precautions should be taken, and appropriate detergents should be used for daily cleaning.

In general, washing with warm soapy water or warm water and vinegar, thorough rinsing, and drying with a cloth is sufficient. The following are to be avoided: hydrochloric acid, abrasive powders, scouring pads, brushes, and silver-cleaning substances.

To guide you in the choice of detergents, Foster offers the “Steel Clean” line of products for cleaning steel:

- **microfibre cloth** to quickly remove traces of grease, oil and dust.
- **professional cream** to restore the original splendour to the steel, removes limescale deposits, stubborn dirt and any rust stains caused by the prolonged contact of ferrous objects.



Steel Clean - cream

Stainless steel cleaning cream | Code | Price

250 ml bottle **8331 000**

pack of 12 pcs **8331 012**



Steel Clean - microfibre

Soft microfibre cloths for cleaning stainless steel | Code | Price

pack of 3 pcs **8333 000**

12 packs of 3 pcs **8333 012**

Mixer taps





MIXER TAPS

Foster



312	Skin <small>NEW</small>	324	Lorenzo	333	S1000 Z65
313	Tube	324	Monza <small>NEW</small>	333	S1000 Z85
314	Iota <small>NEW</small>	325	Omega Plus <small>NEW</small>	334	S1000 RO
315	Play	326	Omega Plus Matt Black	335	Eclipse
316	Milanello	326	Omega	336	Margot <small>NEW</small>
317	FL	327	Omega Matt Black	337	Flat
318	GK	328	Delta	338	Arsenio
319	Magnum	328	Delta Plus	339	Drop
320	Camillo	329	KS	340	Dispenser Quadra
320	1/2 Circle	329	KS Plus	340	Dispenser Round
321	NYC	330	Snake <small>NEW</small>	341	Dispenser Evo
321	Master	331	Atomo <small>NEW</small>		
322	Gamma 3 vie	331	Atomo Plus <small>NEW</small>		
323	Gamma	332	F2000 Alto		
323	KE	332	Bite		



Foster **Mixer Taps**

Hygiene and health

Highest food
safety

Guaranteed by the highest quality materials used

Great sturdiness

Smooth and precise
operation

Thanks to the ceramic cartridges used
and the hoses tested at very high pressures.





Slim lever

Small lever that conceals the opening mechanism



Strengthening plate

All mixer taps come with a strengthening plate that offers perfect stability.



AISI 316 stainless steel

Satin finish AISI 316 stainless steel solutions which guarantees a perfect resistance to corrosion and maximum hygiene and safety, even for food use water.



AISI 304 stainless steel

Enhances the wide range of sinks, ensuring safety even for food use water.



Three-way

Filtered and purified water is separated from the cold and hot water so that they remain apart throughout their flows.



Extractable shower head

The mixer tap shower-head is extractable for easily reaching any area of the sink.



Ceramic cartridges

All mixer taps are fitted with ceramic cartridges that guarantee the highest precision and durability.



Rotating tap body

All mixer taps feature a wide angle of rotation. Some models even permit a full 360° rotation.



Collapsible tap body

Feature that makes it possible to design the sink area in front of a window, so as to enjoy the natural light.



Folding tap body

Perfect for installation under a window.



Double water flow

Many models feature a switch to easily change the flow from continuous to shower.



Flexible tap body

Handy and versatile for reaching any area of the sink.



Ø 35 hole

All mixer taps require a 35 mm diameter hole in the worktop.



Code | Price

- Single-lever mixer tap
- Swivel tap body and flexible shower head
- Strengthening plate: \varnothing 50 mm

8424 100
satin finish

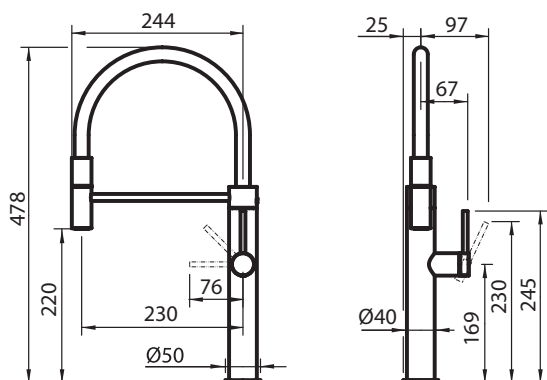

• Also available in version **PVD**

Satin finish
Gun Metal
8424 856



page 34

Satin finish
Copper
8424 858



page 54

Satin finish
Gold
8424 859



page 72

Satin finish
Sunset
8424 851



page 88

Characteristics



Tube



MIXER TAPS

Code

Price

- Single-lever mixer tap
- Swivel tap body and flexible shower head
- Strengthening plate: \varnothing 55 mm

8477 100
satin finish

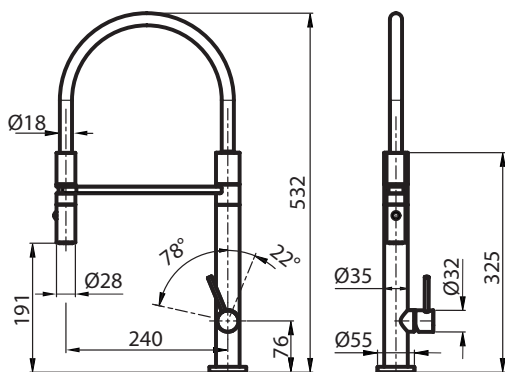

Characteristics





Code | Price

- Single-lever mixer tap
- Swivel tap body and extractable shower-head
- Strengthening plate: \varnothing 50 mm

8426 000
chrome
finish
8426 100
satın finish

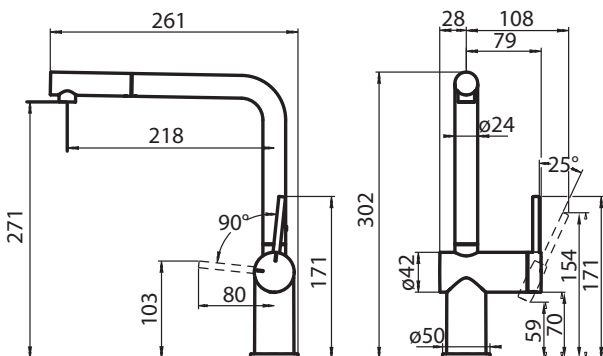

• Also available in version PVD

Satin finish
Gun Metal
8426 106



page 35

Characteristics





Code

Price

- Single-lever mixer tap
- Swivel tap body and flexible shower head
- Strengthening plate: \varnothing 50 mm

8487 000
chrome
finish

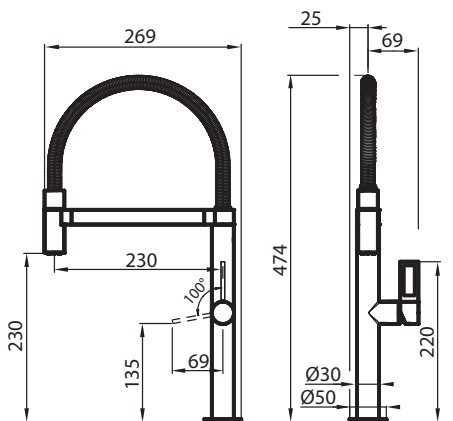

Characteristics



Milanello



Code | Price

- Single-lever mixer tap
- Swivel tap body and flexible shower head
- Stainless steel covering
- Strengthening plate: \varnothing 50 mm

8425 100
satin finish

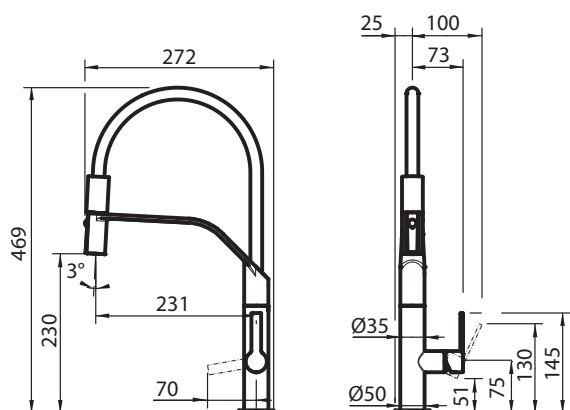

Characteristics





Code

Price

- Single-lever mixer tap
- Swivel tap body and flexible shower head
- Strengthening plate: 48x48 mm

8521 000
chrome
finish

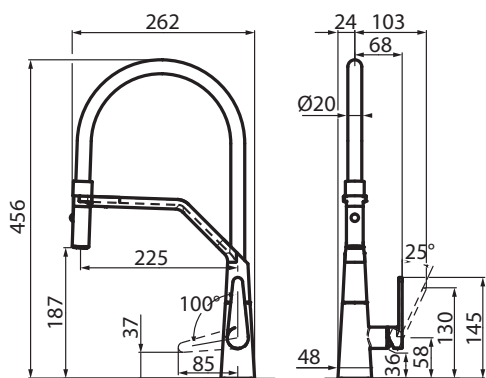

Characteristics





Code | Price

- Single-lever mixer tap
- Swivel tap body and flexible shower head
- Strengthening plate: 62 x 46 mm

8488 000
chrome
finish

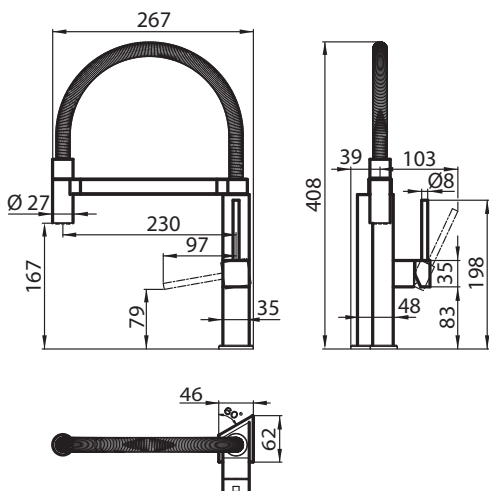

The cabinet of the mixer tap has an irregular shape. It is recommended to check the dimensions for combination with other sinks

Characteristics



Magnum



MIXER TAPS

Code | Price

- Single-lever mixer tap
- Swivel tap body and flexible shower head
- Strengthening plate: \varnothing 50 mm

8484 000
chrome
finish

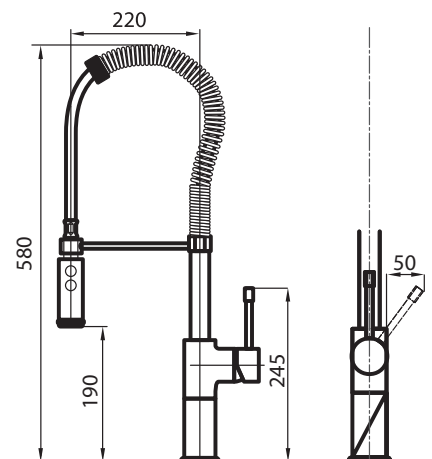

Characteristics



Camillo

Code

Price



- Single-lever mixer tap
- Swivel tap body and extractable shower-head
- Strengthening plate: \varnothing 48 mm

8467 000
chrome finish
8467 100
satin finish

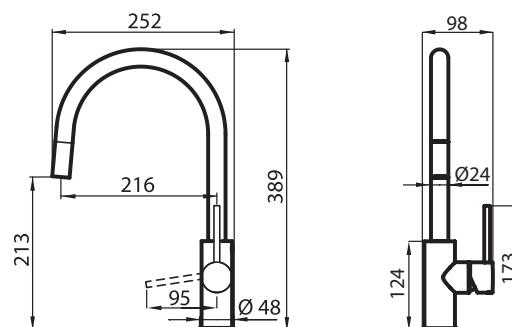

Characteristics



1/2 Circle

Code

Price



- Single-lever mixer tap
- Swivel tap body
- Strengthening plate: \varnothing 50 mm

8480 001
chrome finish

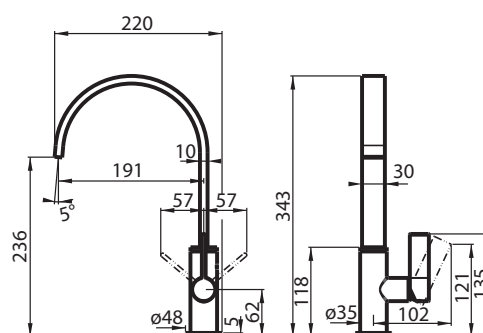

Characteristics



NYC

Code

Price



- Single-lever mixer tap
- Swivel tap body
- Strengthening plate: \varnothing 50 mm

8486 000
chrome
finish

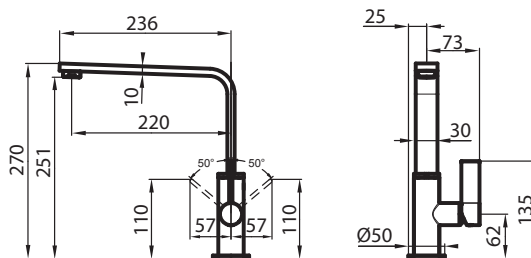

Characteristics



MIXER TAPS

Master

Code

Price



- Single-lever mixer tap
- Swivel tap body
- Strengthening plate: 48x48 mm

8493 000
chrome
finish

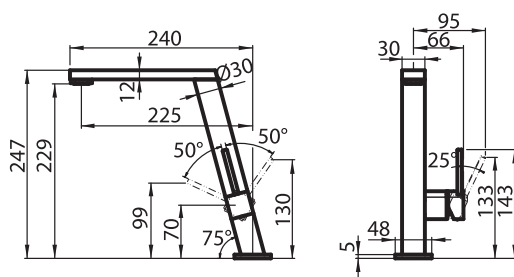

Characteristics



Gamma 3 vie



Code | Price

- Three-way mixer tap with dual control
- Swivel tap body.
- The three ways supply hot/cold and filtered water for food use.
- Aesthetic parts in AISI 316 stainless steel
- Strengthening plate: \varnothing 50 mm

8496 100
satin finish

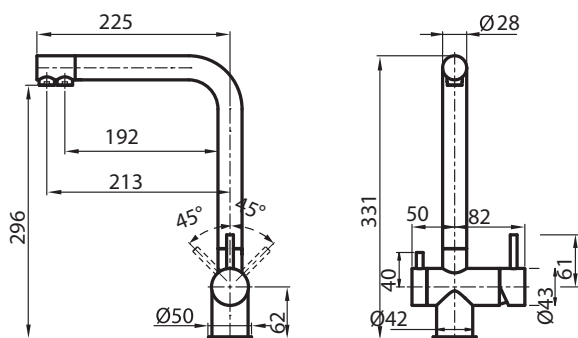

Characteristics



Gamma

Code

Price



- Single-lever mixer tap
- Swivel tap body and extractable shower-head
- Strengthening plate: \varnothing 50 mm

8483 001
chrome
finish

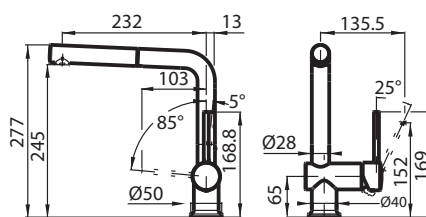

Characteristics



MIXER TAPS

KE

Code

Price



- Single-lever mixer tap
- Swivel tap body and extractable shower-head
- Strengthening plate: \varnothing 50 mm

8492 000
chrome
finish

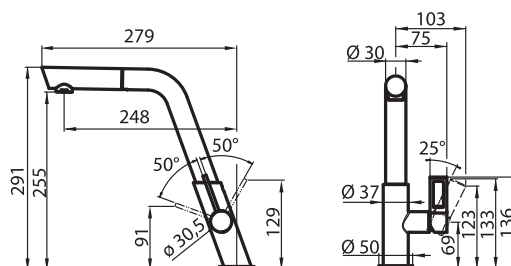

Characteristics



Lorenzo

Code

Price



- Single-lever mixer tap
- Swivel tap body and extractable shower-head
- Strengthening plate: \varnothing 48 mm

8466 000
chrome
finish
8466 100
satin finish

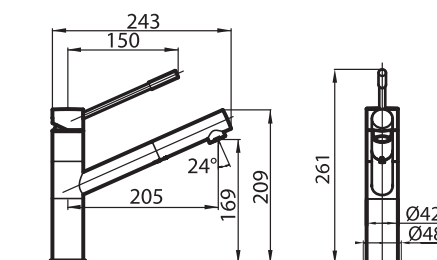

Characteristics



Monza NEW

Code

Price



- Joystick control mixer tap
- Flexible tap body
- Strengthening plate: \varnothing 50 mm

8549 000
chrome
finish

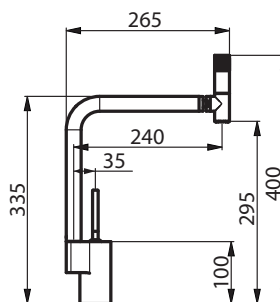

Characteristics



Omega Plus NEW

MIXER TAPS



Code

Price

- Single-lever mixer tap
- Swivel tap body and extractable shower-head
- Strengthening plate: \varnothing 50 mm

8497 020
chrome
finish

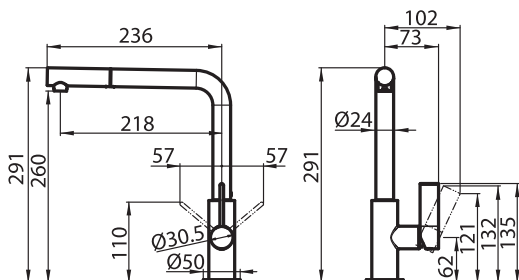

• Also available in version PVD

Chrome finish
Gun Metal
8498 856



page 36

Chrome finish
Copper
8498 858



page 55

Chrome finish
Gold
8498 859



page 73

Chrome finish
Sunset
8498 851



page 89

Characteristics



Omega Plus Matt Black

Code

Price



- Single-lever mixer tap
- Swivel tap body and extractable shower-head
- Strengthening plate: \varnothing 50 mm

8498 626
matt black

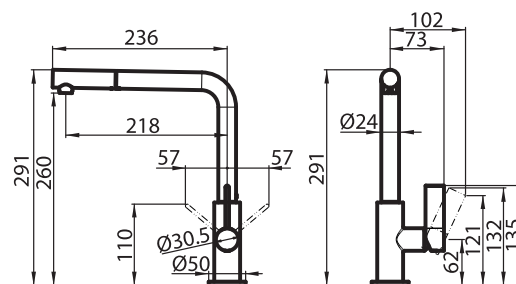

Characteristics



Omega

Code

Price



- Single-lever mixer tap
- Swivel tap body
- Strengthening plate: \varnothing 50 mm

8497 000
chrome
finish
8497 100
satın finish

- Also available in version PVD

Chrome
finish
Gun Metal
8497 856



page 37

Chrome
finish
Copper
8497 400



page 56

Chrome
finish
Gold
8497 700



page 74

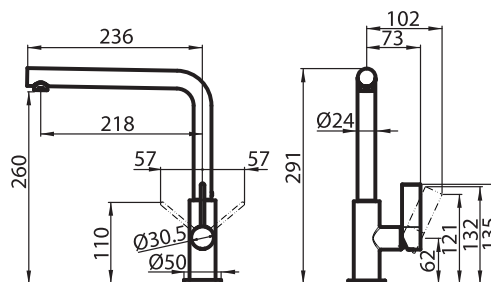

Characteristics



Omega Matt Black

Code

Price



- Single-lever mixer tap
- Swivel tap body
- Strengthening plate: \varnothing 50 mm

8497 606
 matt black

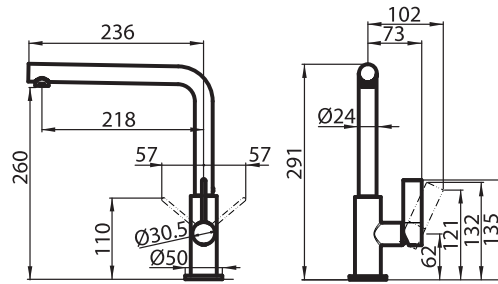

Characteristics



MIXER TAPS

Delta

Code

Price



- Single-lever mixer tap
- Swivel tap body
- Strengthening plate: \varnothing 48 mm

8441 000
chrome
finish

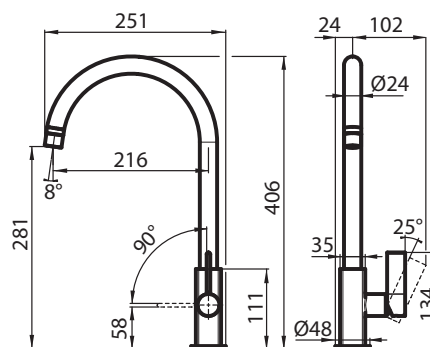

Characteristics



Delta Plus

Code

Price



- Single-lever mixer tap
- Swivel tap body and extractable shower-head
- Strengthening plate: \varnothing 48 mm

8441 030
chrome
finish

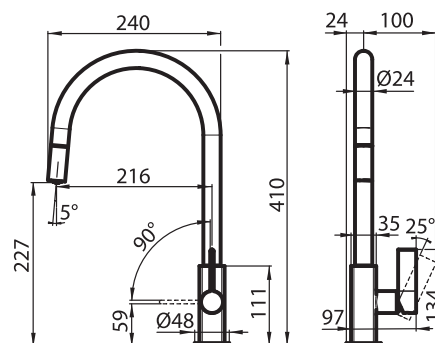

Characteristics



KS

Code

Price



- Single-lever mixer tap
- Swivel tap body
- Strengthening plate: \varnothing 50 mm

8485 002
chrome
finish

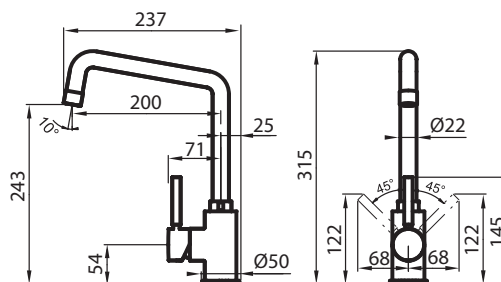

Characteristics



KS Plus

Code

Price



- Single-lever mixer tap
- Swivel tap body and extractable shower-head
- Strengthening plate: \varnothing 50 mm

8522 000
chrome
finish
8522 100
satın finish

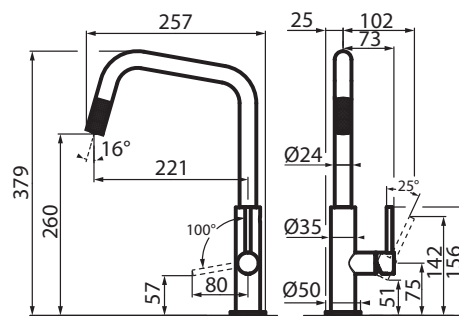

Characteristics





Code

Price

- Single-lever mixer tap
- Swivel tap body and flexible shower head
- Strengthening plate: \varnothing 50 mm

8525 000
chrome
finish

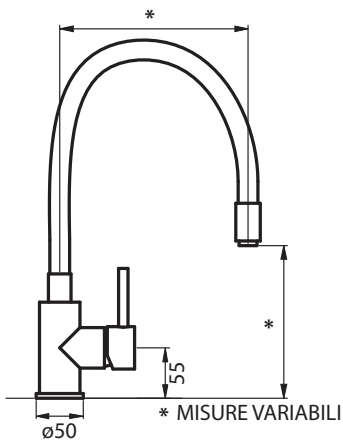

The tap body is flexible and retains its shape.

Characteristics



Atomo NEW

Code

Price



- Single-lever mixer tap
- Swivel tap body and extractable shower-head
- Strengthening plate: \varnothing 50 mm

8550 000
satin finish

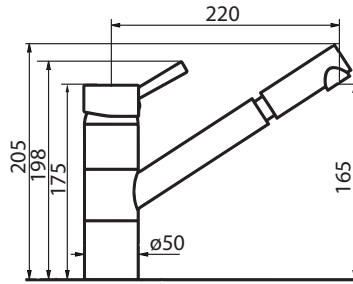

Characteristics



MIXER TAPS

Atomo Plus NEW

Code

Price



- Single-lever mixer tap
- Swivel tap body and extractable shower-head
- Strengthening plate: \varnothing 48 mm

8551 000
satin finish

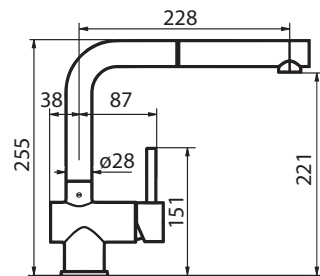

Characteristics



F2000 - Alto

Code

Price



- Single-lever mixer tap
- Swivel tap body
- Strengthening plate: \varnothing 50 mm

8458 001
chrome
finish

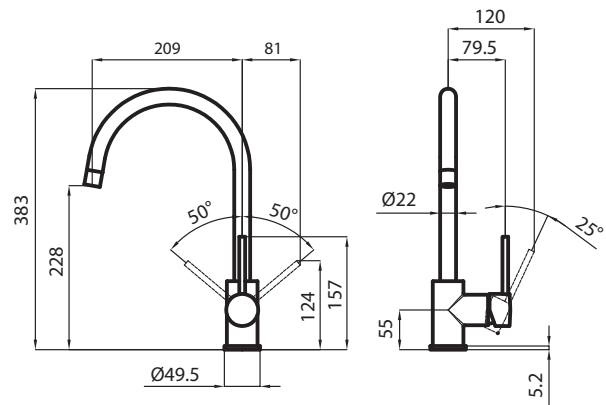

Characteristics



Bite

Code

Price



- Single-lever mixer tap
- Swivel tap body
- Strengthening plate: \varnothing 54 mm

8481 000
chrome
finish

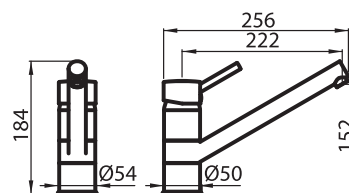

Characteristics



S1000 - Z65

Code

Price



- Single-lever mixer tap
- Swivel tap body and extractable shower head
- Strengthening plate: \varnothing 55 mm

8449 500
chrome
finish

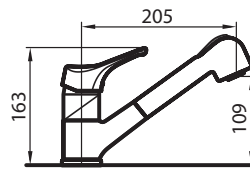

Characteristics



MIXER TAPS

S1000 - Z85

Code

Price



- Single-lever mixer tap
- Swivel tap body
- Strengthening plate: \varnothing 48 mm

8442 500
chrome
finish

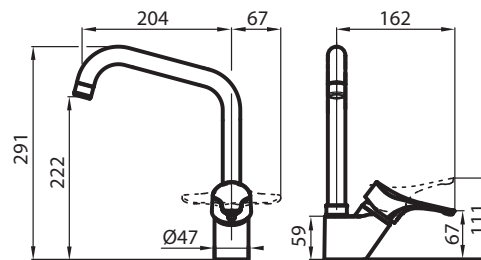

Characteristics



S1000 - RO

Code

Price



- Single-lever mixer tap
- Swivel tap body
- Strengthening plate: \varnothing 50 mm

8443 002
chrome
finish

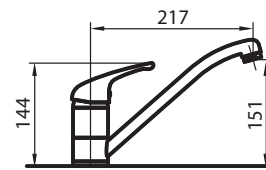

Characteristics



Eclipse

collapsible

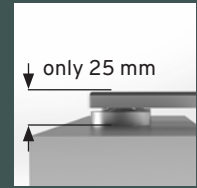

small footprint

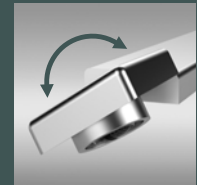

swivel head



MIXER TAPS

Code

Price

- Single-lever mixer tap
- Collapsible swivel tap body (up & down)
- Strengthening plate: \varnothing 44 mm
- Maximum rear dimension (for lever rotation) 40 mm from centre of hole
- Remote control
- Head rotation: 60°
- Mixer/control centre to centre distance: see website

8499 000
chrome
finish

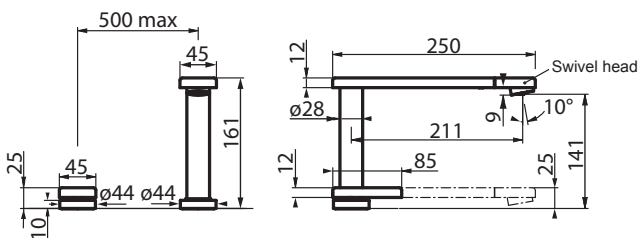

Characteristics



Margot NEW

collapsible



Code | Price

- Single-lever mixer tap
- Collapsible swivel tap body (up & down)
- Strengthening plate: \varnothing 55 mm

8524 000
chrome
finish
8524 100
satin finish

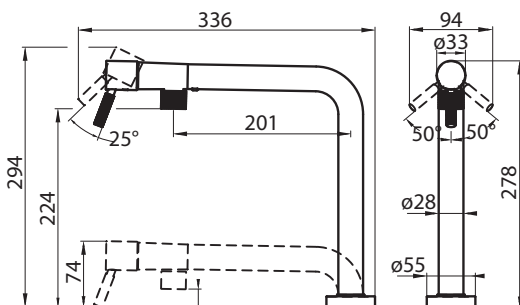
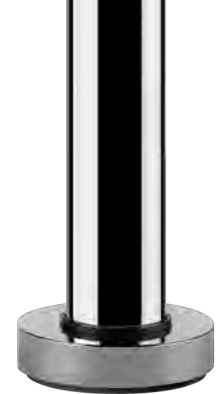

• Also available in version **PVD**

Chrome
finish
Gun Metal
8524 006



Chrome
finish
Copper
8524 008

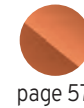

Chrome
finish
Gold
8524 009

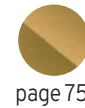

Characteristics



Flat

collapsible



Code	Price
------	-------

8478 001
chrome
finish

- Single-lever mixer tap
- Collapsible swivel tap body (Up&Down)
- Remote control
- Holes distance: max 500 mm - min. 85 mm
- Strengthening plate: \varnothing 52 mm

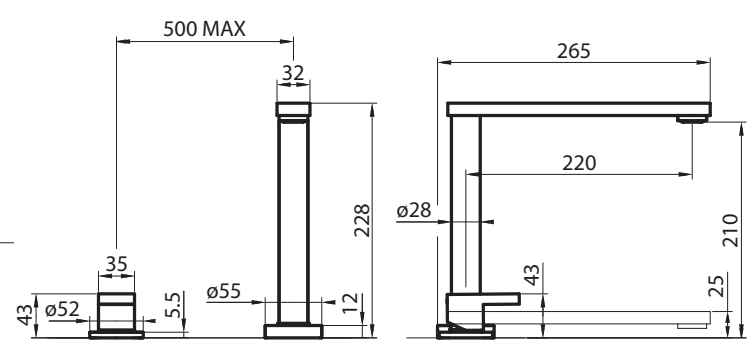

Characteristics



MIXER TAPS

Arsenio

collapsible



Code

Price

- Single-lever mixer tap
- Collapsible swivel tap body (Up&Down)
- Extractable shower-head
- Remote control
- Holes distance: max 500 mm - min. 85 mm
- Strengthening plate: \varnothing 52 mm

8471 000
chrome
finish

Characteristics

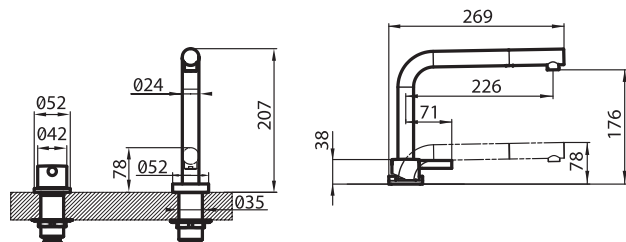

Drop swivel



MIXER TAPS

Code

Price

- Single-lever mixer tap
- Swivel and collapsible tap body
- Strengthening plate: \varnothing 48 mm

8523 000
chrome
finish

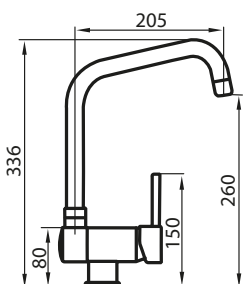

Characteristics



Dispenser Quadra

Characteristics

Code

Price



Built-in dispenser
for liquid detergent/soap

8520 000
chrome
finish

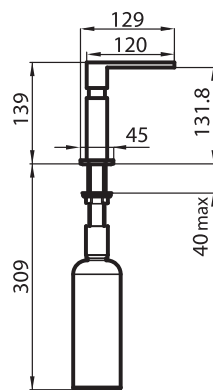

Dispenser Round

Characteristics

Code

Price



Built-in dispenser
for liquid detergent/soap

8530 000
chrome
finish

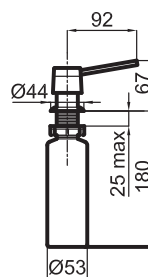

Dispenser Evo

Characteristics

Code

Price



Built-in dispenser for liquid detergent/soap

8520 010
chrome
finish
8520 100
satin finish

• Also available
in version **PVD**

Chrome
finish
Gun Metal
8520 856



page 39

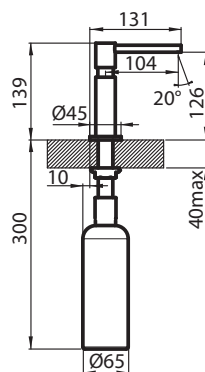

Equipped troughs **NEW**





EQUIPPED
TROUGH





Equipped troughs **NEW**

Equipped troughs, accessorised with a combination of movable and interchangeable elements that can be placed wherever required, offer the perfect solution to enhance the use of the worktop.

- 347 | Top-mount **equipped troughs**
- 348 | Undermount **equipped troughs**
- 350 | Accessories
- 353 | Top-mount slim **equipped troughs**
- 354 | Undermount slim **equipped troughs**
- 356 | Slim **trough accessories**
- 357 | Technical drawings
- 358 | Galante **sink**

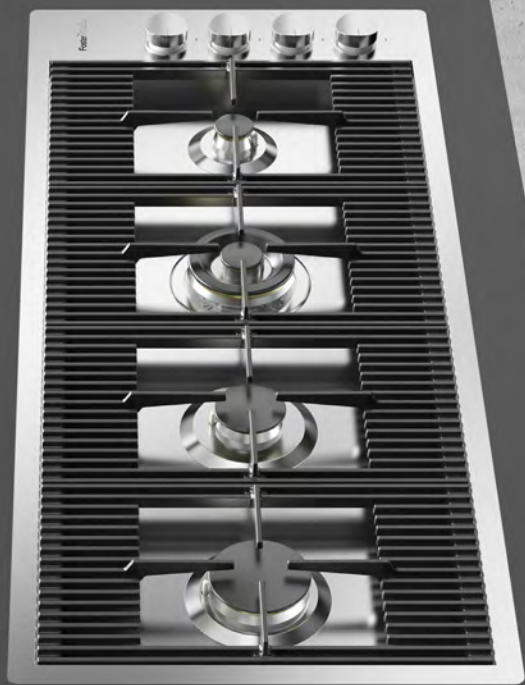

Equipped troughs

top-mount | flush-mount

Code	Version	Characteristics	Price
------	---------	-----------------	-------

3024 800	FT	FT cut-out: see website*	
	SPT	SPT cut-out: 432 x 152	

- Satin finish AISI 304 stainless steel
- External dimensions: **450 x 170** Internal dimensions: **422 x 142**
- 1/4" waste fitting
- Length "L": 3 units



Accessories on page 350

Cabinet 90

3025 800	FT	FT cut-out: see website*	
	SPT	SPT cut-out: 832 x 152	

- Satin finish AISI 304 stainless steel
- External dimensions: **870 x 170** Internal dimensions: **842 x 142**
- 1/4" waste fitting
- Length "L": 6 units



Accessories on page 350

Cabinet 120

3026 800	FT	FT cut-out: see website*	
	SPT	SPT cut-out: 1132 x 152	

- Satin finish AISI 304 stainless steel
- External dimensions: **1150 x 170** Internal dimensions: **1122 x 142**
- 1/4" waste fitting
- Length "L": 8 units



Accessories on page 350

Equipped troughs undermount

Code

Version

Characteristics

Price

Cabinet 60

3024 880  **ST** ST cut-out: 422 x 142

- Satin finish AISI 304 stainless steel
- External dimensions: **438 x 170** Internal dimensions: **422 x 122**
- 1/4" waste fitting
- Length "L": 3 units



Accessories on page 350

Cabinet 90

3025 880  **ST** ST cut-out: 842 x 142

- Satin finish AISI 304 stainless steel
- External dimensions: **858 x 170** Internal dimensions: **842 x 122**
- 1/4" waste fitting
- Length "L": 6 units



Accessories on page 350

Cabinet 120

3026 880  **ST** ST cut-out: 1122 x 142

- Satin finish AISI 304 stainless steel
- External dimensions: **1138 x 170** Internal dimensions: **1122 x 122**
- 1/4" waste fitting
- Length "L": 8 units



Accessories on page 350

Installation note

*Recommended thickness for a perfect combination with accessories.

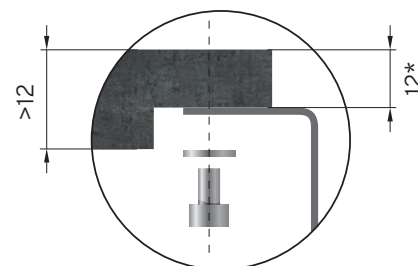
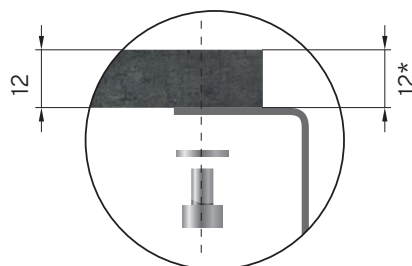

Key to understanding the accessories

The lengths of the troughs and accessories are indicated in “units”; for the composition, the sum of the “units” of the accessories must be the same as the length in “units” of the trough.

Top-mount **equipped troughs**

E.g. trough 3026 800 of “L8 units” consisting of:
8151 023 “L2 units”, 1773 100 “L2 units”, 8100 703 “L4 units”.



Undermount **equipped troughs**

E.g. trough 3026 800 of “L8 units” consisting of:
1773 100 “L2 units”, 8100 058 “L2 units”, 8100 706 “L4 units”.

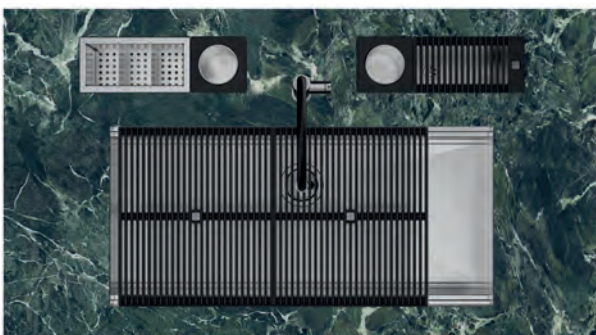

Equipped troughs | accessories

Stainless steel compartment with three containers (Removable containers) 8151 003
L=2 (28x14 cm)



Kit "A": Stainless steel compartment with five containers 8100 703
Iroko chopping board L=4 (56x14 cm)
Stainless steel bottle holder
*note 1



Black drainer 8100 058
L=2 (28x14 cm)



Kit "B": Iroko chopping board 8100 700
Stainless steel bottle holder L=4 (56x14 cm)
The following Black grids can be housed in the free space:
8100 617 Quadra R12 / Phantom / Quadra / KE
8100 602 Milanello
8100600 Milano
*note 1



Stainless steel knife holder 8100 712
+ Black support for resting blades L=3 (42x14 cm)



Kit "N": (Only for Series 35 bowls) 8100 714
Iroko chopping board L=4 (56x14 cm)
8643 117
Black grid
8100 618
Stainless steel bottle holder



2 Schuko sockets 8000 020
1 USB socket for charging L=2 (28x14 cm)



Black knife holder
can only be combined
with
8100 700, 8100 703,
8100 704, 8100 706

8100 030



Kit "D": stainless steel
bottle holder

8100 704

L=1
(14x14 cm)



Kit "E": Stainless steel
bowl with lid

8100 705

L=2
(28x14 cm)



Kit "F": Multifunction scale*
2 terracotta bowls with
stainless steel lid
2 glass salt shakers
2 stainless steel bottle holders

8100 706

L=4
(56x14 cm)



Kit "G": Iroko chopping board
2 terracotta bowls with
stainless steel lid
Multifunction scale**
*note 1

8100 710

L=3
(42x14 cm)



Kit "H": 2 terracotta
bowls with
stainless steel
lid
Stainless steel
bowl with lid

8100 702

L=3
(42x14 cm)



Stainless steel plate
rack

1773 100

L=2
(28x14 cm)

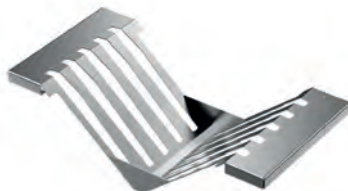

Kit "C": 2 terracotta
bowls with
stainless
steel lid

8100 701

L=2
(28x14 cm)



*note 1: The chopping board can only be used in 400 mm deep bowls

** Scale features:
Dimension 21.4 x 16.5 cm - Max capacity 5 kg.
Bluetooth connection to smartphone
Free access to the smartapple app
Database with more than 430 stored foods.

EQUIPPED
TROUGHS

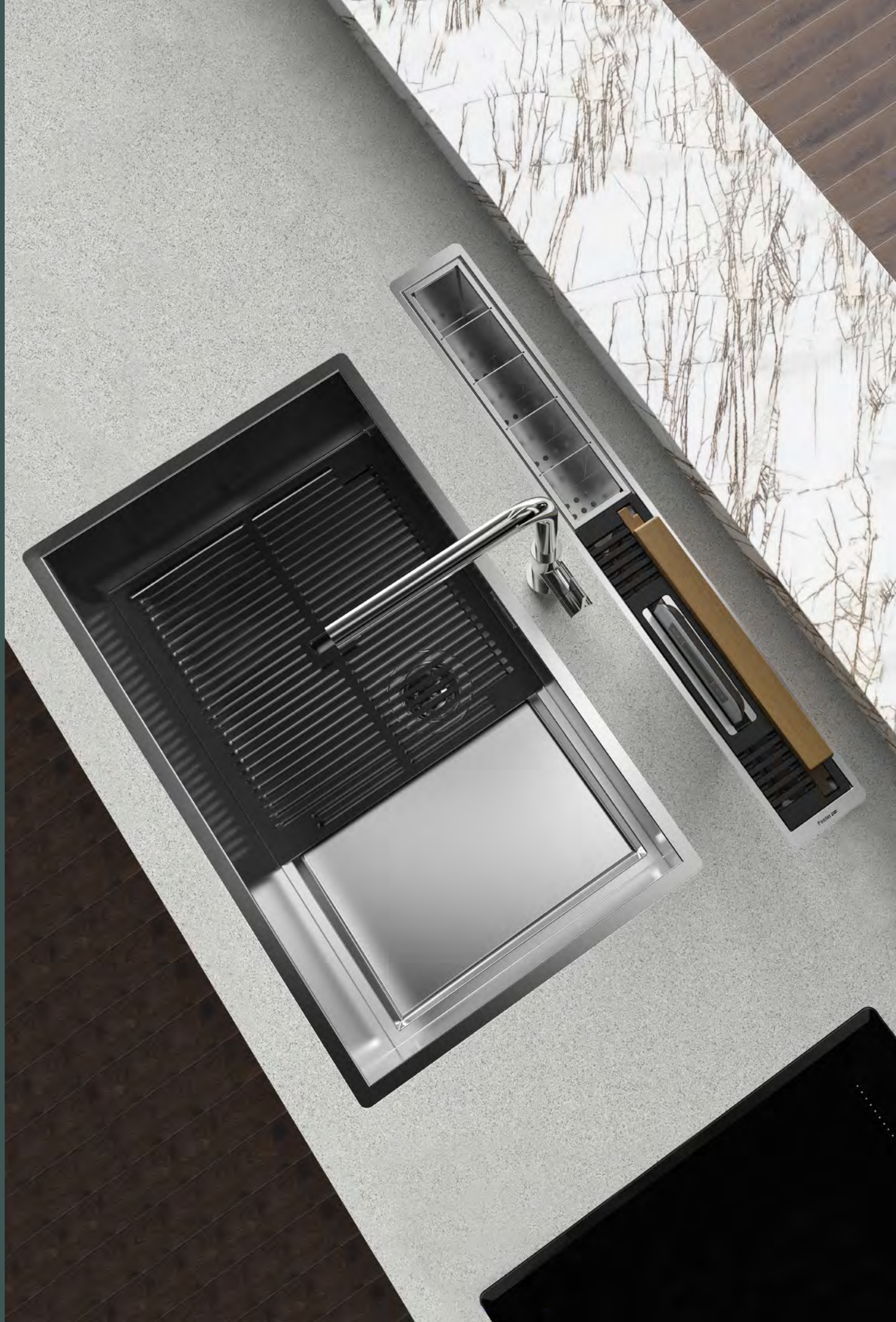

Foster 200

Slim equipped troughs

top-mount | flush-mount

Code	Version	Characteristics	Price
------	---------	-----------------	-------

- 3024 801**  FT FT cut-out: see website*
-  SPT SPT cut-out: 400 x 100

- Satin finish AISI 304 stainless steel
- External dimensions: **430 x 110** Internal dimensions: **390 x 90**
- 1/4" waste fitting
- Length "L": 1 unit



Accessories on page 356

Cabinet 90

- 3025 801**  FT FT cut-out: see website*
-  SPT SPT cut-out: 840 x 100

- Satin finish AISI 304 stainless steel
- External dimensions: **870 x 110** Internal dimensions: **830 x 90**
- 1/4" waste fitting
- Length "L": 3 units



Accessories on page 356

Slim equipped troughs undermount

Code

Version

Characteristics

Price

Cabinet 45

3024 881

ST

ST cut-out: 390 x 90

- Satin finish AISI 304 stainless steel
- External dimensions: **406 x 120** Internal dimensions: **390 x 72**
- 1/4" waste fitting
- Length "L": 1 unit



Accessories on page 356

Cabinet 90

3025 881

ST

ST cut-out: 830 x 90

- Satin finish AISI 304 stainless steel
- External dimensions: **846 x 120** Internal dimensions: **830 x 72**
- 1/4" waste fitting
- Length "L": 3 units



Accessories on page 356

Installation note

*Recommended thickness for a perfect combination with accessories.

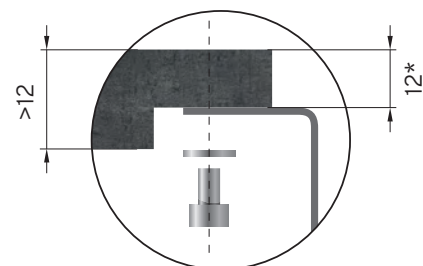
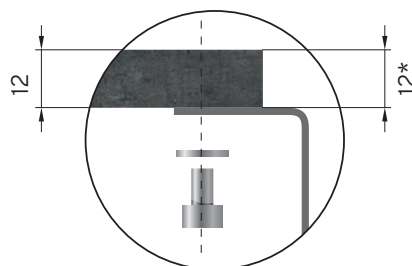

Key to understanding the accessories

The lengths of the troughs and accessories are indicated in “units”; for the composition, the sum of the “units” of the accessories must be the same as the length in “units” of the trough.

Top-mount Slim **equipped troughs**

E.g. trough 3025 801 of “L3 units” consisting of:
8100 708 “L2 units”, 8151 004 “L1 unit”.

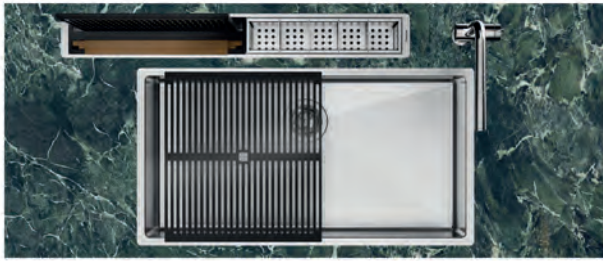

Undermount Slim **equipped troughs**

E.g. trough 3025 881 of “L3 units” consisting of:
8100 708 “L2 units”, 8151 004 “L1 unit”.



Slim equipped troughs

accessories

Kit "M": Iroko chopping board 8100 709
 The following grids
 can be housed
 in the free space:
 8100 602 Milanello
 8100 617 Quadra R12, Phantom,
 Quadra, KE
 8100 600 Milano
 *note 1



Kit "L": Iroko chopping board 8100 708
 Multifunction scale**
 *note 1



Kit "I": Iroko chopping board 8100 707
 The following grids can
 be housed in the free
 space:
 8100 602 Milanello
 *note 1



Kit "O": (Only for
 Series 35 bowls)
 Iroko chopping board 8100 715
 8643 117
 Black grid L=1
 8100 618 (38x8.8 cm)



Stainless steel com-
 partment 8151 004
 with five containers
 (Removable contain-
 ers) L=1
 (38x8.8 cm)



*note 1: The chopping board can only be used in 400 mm deep bowls

** Scale features:
 Dimension 21.4 x 16.5 cm - Max capacity 5 kg.
 Bluetooth connection to smartphone
 Free access to the smartapple app
 Database with more than 430 stored foods.

Equipped troughs

technical drawings

Top-mount

3024 800

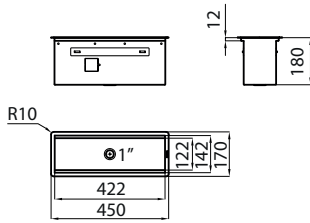

3025 800

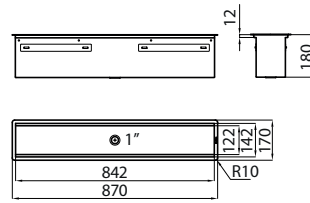

3026 800

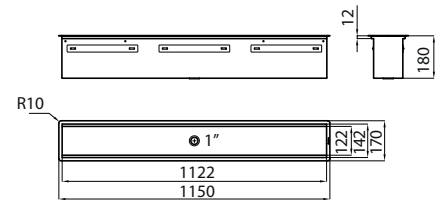

Undermount

3024 880

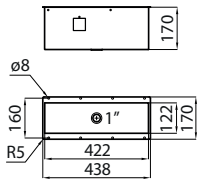

3025 880

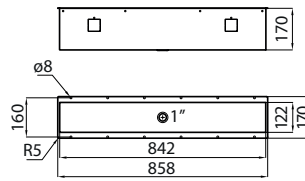

3026 880

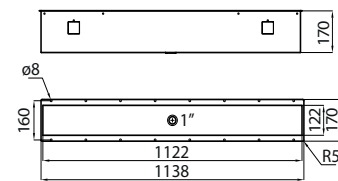

Slim equipped troughs

technical drawings

Top-mount

3024 801

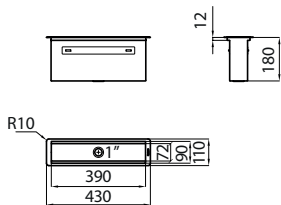

3025 801

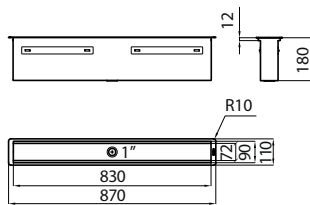

Undermount

3024 881

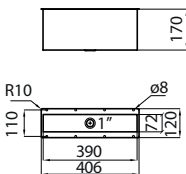

3025 881

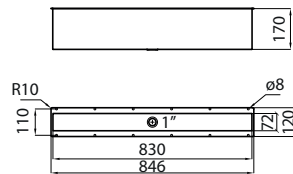

EQUIPPED TROUGHS

Galante sink

NEW

top-mount | flush-mount | undermount





New work station concept:

an equipped trough fitted inside the sink can be used to house the accessories included, chopping board and Black grid, when not in use.

A wide range of accessories

allows you to create a workstation customised to suit your needs.

EQUIPPED TROUGHS

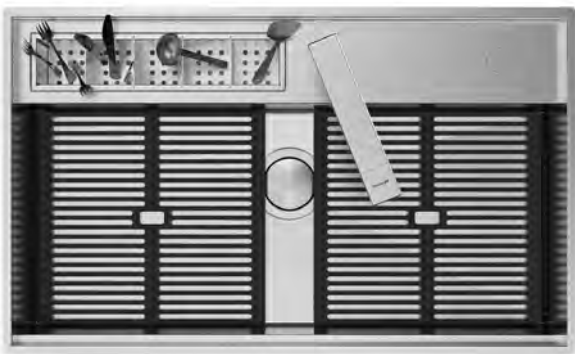

Galante sink

top-mount | flush-mount | undermount



Code

Version

Characteristics

Price

Cabinet 90



3780 000

FT

FT cut-out: see website

SPT

SPT cut-out: 845 x 505 R10

ST

SPT cut-out: 830 x 490

- Satin finish AISI 304 stainless steel
- Dimensions: **860 x 520** - 1 bowl: **830 x 350**
- Space Push automatic waste fitting
- Additional holes available

Included: **grid** (8100 618), **chopping board** (8643 117) and **Black support**

Accessories at the bottom of the page

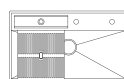

Configuration of Black grids flush with bowl

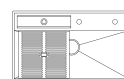

Configuration of Black grids at bottom of bowl

Galante sink

accessories included

Black support



Black grid
36.8 x 34.2 cm
8100 618



Iroko chopping board
26x36.6 cm
8643 117



optional accessories

Stainless steel compartment with 5 containers (removable containers)
(38.8x8.8 cm)
8151 004



Stainless steel plate rack
23x37.5 cm
8100 305

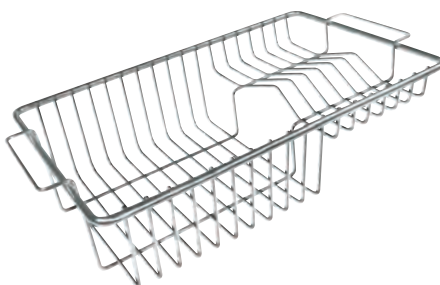

3780 000

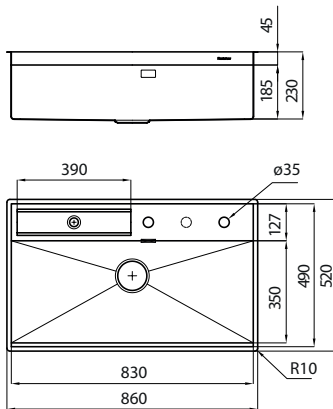

Drawing of position of accessories on steps

The “step” system makes the combined use of countless accessories possible. Grids, chopping boards, tool holders, trays and containers of various sizes can be moved around the work area with a simple gesture and can be stacked so that they are always within reach.

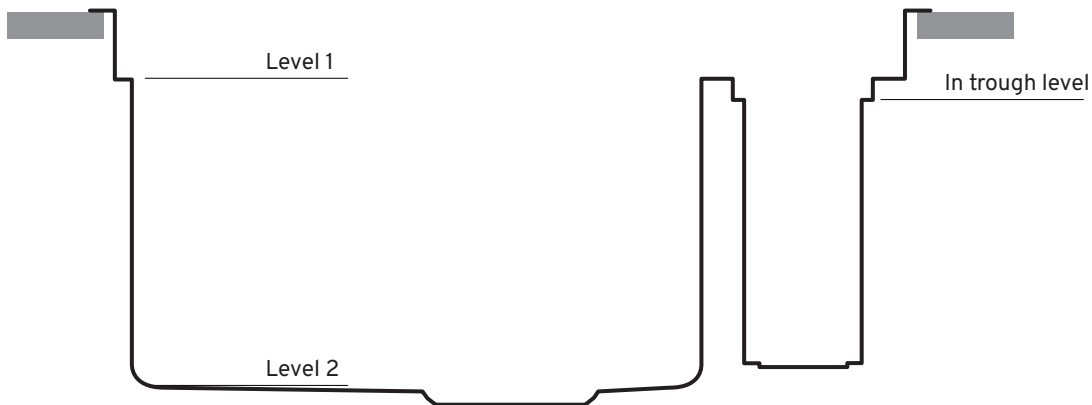



0/1 0 III **Foster** INDUCTION P II



INDUCTION
HOBS

Induction hobs



Energy saving

Precise and versatile control

Easy to clean

High energy efficiency, nine power settings and the powerboost option guarantee precise and fast cooking. The cooking zone only activates on the bottom of the pot and keeps the rest of the hob cool, which, thanks to its smooth surface, makes it easier to clean.

Absorption examples by cooking type

cooking levels	cooking type	examples of use
1-2	very gentle	melting, bain-marie
3-4	gentle	heating, simmering
5-7	medium	sauces, rice
7-9	high heat	roasting, frying
Powerboost	reduced time	boiling liquids

The high power output of Foster induction hobs suggests high energy consumption. On the contrary, most cooking requires reduced power, as can be seen in the table.

Built-in types

Induction models can be installed either on the worktop or flush with it, creating a recess of the worktop.

Installation for hobs with bevelled edge



Bevelled edge

Sloping (bevelled) edge that creates a sleek, elegant appearance and exactly matches Flat edge sinks.

Installation for hobs with straight edge



Straight edge

Installation with straight edge, protruding only 4mm above the worktop





Bridge

The bridge function combines two zones to form a single extended cooking zone.



Power control

Utmost freedom of use. The user can easily change the maximum power level of the hob according to needs and reprogram at any time to modify or remove the power limit.



T-chef

Used to set particular temperatures (42°C, 70°C, 94°C) and keep them constant during cooking



Powerboost

The Booster function [P] provides increased power to the selected plate for a few minutes.



Slider control

Simply touch the Touch display to set the desired power level.



Safety

All hobs feature the most modern and sophisticated safety protections: Centralised power-off function; Safety lock; Residual heat warning lights; Safety System that turns off the hob when there are no pots; Overflow detector that automatically turns off the plate in case of liquid overflow; Automatic deactivation to prevent accidents caused by forgetfulness.



Pot Speed Test

This function tests your pots and displays a rating from 0 to 3 according to heating efficiency and speed.



Pause

Allows you to interrupt and restore the settings immediately.



Heat holding

Keeps your food warm (70°C).



Chef cook

A real chef function: the hob automatically sets scaled power levels in the different cooking zones, which are automatically activated on contact with the pot. This makes it possible to cook at different power levels without adjusting them each time, simply by moving the pot on the hob.



Intelligent Pot Localization

It recognises which zone the pot is placed on and automatically activates the relative controls for power adjustment.



Double Powerboost

Two additional power settings reaching up to 3700 W can be used on a single zone or distributed over the entire extended Bridge (where present).



End of cooking programming

Each plate is capable of independent programming, and thus the possibility to set different cooking times.



Timer

Additional timer from the end-of-cooking function.



Pot Detector

This feature detects the pot resting on it and calculates the area it covers. The plates switch off automatically when the pot is removed.



Go&Stop automatic mode

This initially turns on the plates at maximum power until the set level has been reached.



Automatic Bridge

When a pot occupies 2 different zones, the Bridge function is automatically activated.



Recall

This feature allows you to call back the last settings selected in the previous cooking.



Smart fan system

Correct ventilation is essential for ensuring the efficient operation of the induction hobs. The Foster system automatically adjusts the degree of ventilation according to the temperatures reached.



Foster
INDUCTION

△
M
+
○
-

+
-
○
+
+



368	KE Arya Black	NEW
370	Milano Air	
375	KE Induction	NEW
378	S4000 Domino Line	
382	S1000	NEW
384	Modular Induction Series	
388	Modular Quadra Series	

KE Arya Black

NEW



KE Arya Black NEW

MOTOR ON BOARD



Code	Version	Characteristics	Price
------	---------	-----------------	-------

7392 246	 SF	SF cut-out: 760 x 480	
	 FT	FT cut-out: see website	

Dimension: 820 x 520

Maximum power	7,400 W**
4 zones	210x190 mm 2,100 (3,000)* W
2 extended Bridge zones	3,700 W

* Powerboost

** with the PowerControl function, the maximum power can be set by the user from 2,400 W to 7,400 W in 100 W steps

Power supply: single-phase 230V~1P+N
two-phase 400V~2P+N
frequency 50-60 Hz



Induction hob with integrated extractor hood

- Finish: Black ceramic glass

Induction characteristics:

- Electronic programming
- Double Bridge function
- PowerControl function
- 9 power settings per zone
- Powerboost function
- Touch control commands
- Pot detector
- Safety equipment.

Suction characteristics:

- Suction hood operation
- Electronic programming
- 10 suction speeds (9 + 1 intensive);
- 2 washable grease filters
- Automatic delayed switch-off
- Grease and carbon filter saturation warnings
- Optional filtering operation with carbon filters
- **Energy class: A+**
- max.m³/h: 543
- int.m³/h: 647
- pressure (PA): 610
- Max.noise level (dbA): 66
- Int.noise level (dbA): 70
- Suction power (W): 165

Filtering kit: see page 373

Ducting accessories: see page 373

- Grid also available in version **PVD**

Satin finish stainless steel 8803 000



Satin finish Gun Metal 8803 116



Satin finish Copper 8803 118



Satin finish Gold 8803 119



Foster Milano Air



Six suction speeds

Six speeds and a flow rate of 680 m³/h ensure powerful and effective suction in every situation.

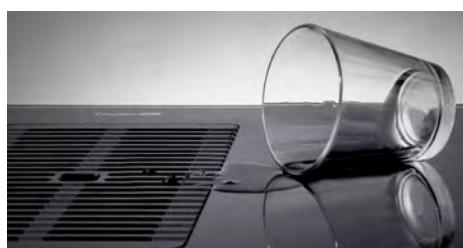

Overflow liquid collection

The containment tank under the grid allows the collection of overflow liquids up to 1.5 litres.



Smooth surface

Milano Air is perfectly flush, even in the intake area. The pots can slide on the top safely.

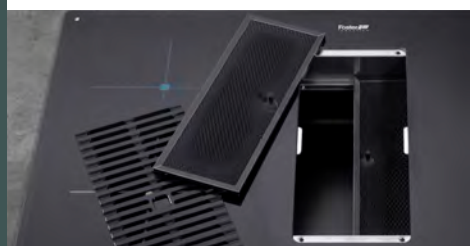

Easy access to filters

The ergonomic shape of the grid allows easy access to the filters and the collection tank for cleaning operations.



Double Bridge zone

Foster Milano Air has two large extended cooking zones, which can be activated with the Bridge function



Intuitive control

The functional touch panel easily and immediately controls the cooking zones and the suction function.

Foster Milano Air

REMOTE MOTOR

Code	Version	Characteristics	Price
------	---------	-----------------	-------



7391 245



SF cut-out: 810 x 500

FT cut-out: see website

Dimension: 860 x 530

Maximum power 3,000, 4,000, **7,400 W****
 2 front zones Ø 160 mm 1,200 (1,600)* W
 2 rear zones Ø 200 mm 2,300 (3,000)* W
 2 extended Bridge zones 3,700 W

* Powerboost

** with the PowerControl function, the maximum power can be set by the user to the listed values

Power supply: 230 - 380 V
50/60 Hz



Induction hob with integrated extractor hood

• Finish: Black ceramic glass

Induction characteristics:

- Electronic programming
- Double Bridge function
- PowerControl function
- 9 power settings per zone
- Powerboost function
- Touch control commands
- Pot detector
- Safety equipment.

Suction characteristics:

- Suction hood operation
- Electronic programming
- 6 suction speeds (4 + 2 intensive);
- 2 washable grease filters
- Automatic delayed switch-off
- Grease and carbon filter saturation warnings
- Optional filtering operation with carbon filters

• Energy class: A++

- max.m³/h: 500
- int.m³/h: 680
- pressure (PA): 778
- Max.noise level (dba): 66
- Int.noise level (dba): 74
- Suction power (W): 170

Filtering kit: see page 373

Ducting accessories: see page 373

Carbon filter 9700 529

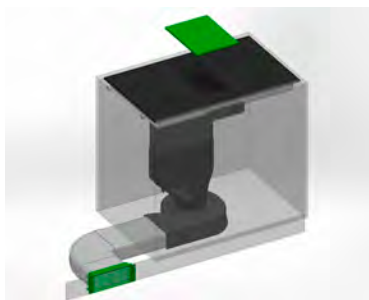

Filter set with carbon filter (9700529) and plinth mask (9700539).

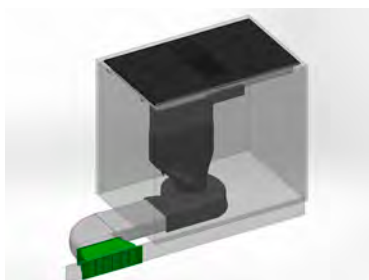

Filter set with plinth filter (9700574).



Minimum footprint. Installation of the Foster Milano Air hob is simple and versatile. The geometries of the hood leave plenty of space under the top with the possibility of using two large drawers. The motor, which resides on the ground under the base of the cabinet, can be rotated to facilitate the flow of air in the most appropriate direction.

Ducting accessories



KE Arya Black Filtering kit

Filtering kit

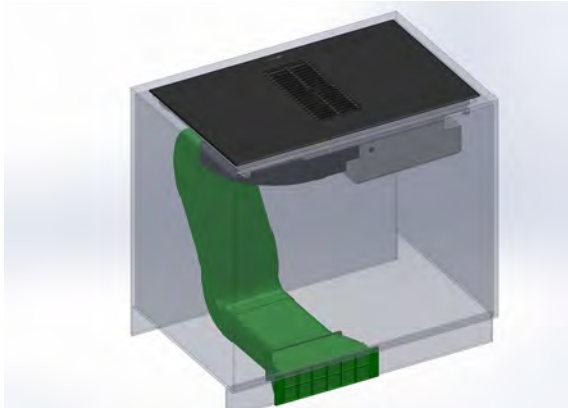

9700 580

Complete filtering kit for H10/15 cm plinth with stainless steel mask.

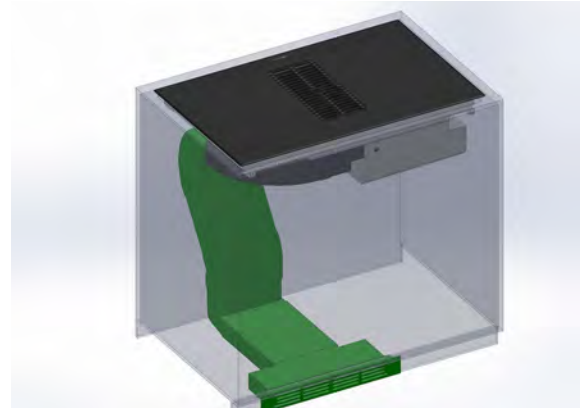

9700 577

Complete filtering kit for H6/8 cm plinth with stainless steel mask.

Ducting accessories for suction hobs and hoods

Space-saving ducting system with rectangular section



9700 532

white tube with rectangular section 222x89 mm

dim: 222x89x1000 mm



9700 533

white connector with rectangular section 227x94 mm

dim: 227x94x80 mm



9700 534

horizontal 90° corner connector with rectangular section: 227x94 mm

dim: 288x288x94 mm



9700 535

vertical 90° corner connector with rectangular section: 227x94 mm

dim: 174x174x227 mm



9700 536

horizontal 15° corner connector with rectangular section: 227x94 mm

dim: 233x138x94 mm



9700 537

rect. / round adapter sect. 227x94 mm / ø 158 mm

dim: 190x 150x227 mm



9700 538

no-return valve ø 148 mm



9700 539 *

grey grid for plinth for plinths 100/150 mm

dim: 273x150 mm

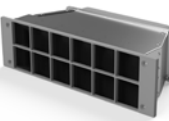

9700 574 *

carbon filter for plinth 100-150 mm

9700 575 *

active carbon refill for filter plinth

* only for Ghost hoods and suction hobs.



KE Induction

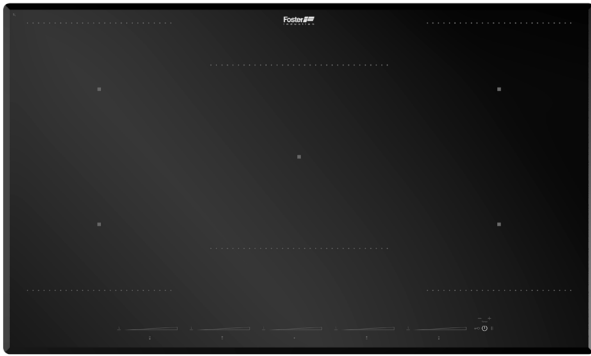

KE Induction

Code	Version	Characteristics	Price
------	---------	-----------------	-------



7384 646  SF SF cut-out: 840 x 480
 FT FT cut-out: see website

- Dimensions: 860 x 510
- Finish: Black ceramic glass
- Electronic programming;
- 5 cooking zones with double extended Bridge zone
- 9 power settings per zone plus Powerboost function

Maximum power 2,800, 3,500, 3,700, 4,500, 6,000, 7,400, 10,400 W**
 4 x 210x190 mm 2,100 (3,000)* W
 ø 250 mm 2,300 (3,000)* W

* Powerboost

Power supply: 230 - 380 V
50/60 Hz



Cut-out
48 cm deep

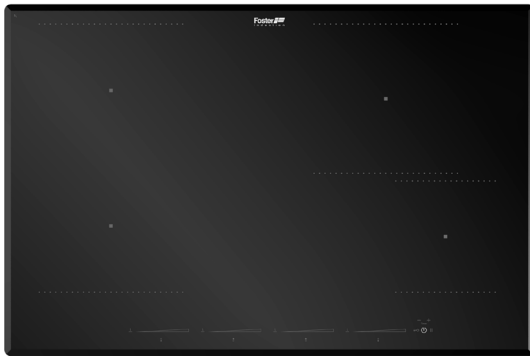

7382 646  SF SF cut-out: 750 x 480
 FT FT cut-out: see website

- Dimensions: 770 x 510
- Finish: Black ceramic glass
- Electronic programming;
- 4 cooking zones with double extended Bridge zone
- 9 power settings per zone plus Powerboost function

Maximum power 1,500, 2,800, 3,500, 3,700, 4,500, 6,000, 7,400 W**
 2 x 210x190 mm 2,100 (3,000)* W
 ø 200 mm 2,300 (3,000)* W
 ø 145 mm 1,400 (1,850)* W



* Powerboost

Power supply: 230 - 380 V
50/60 Hz

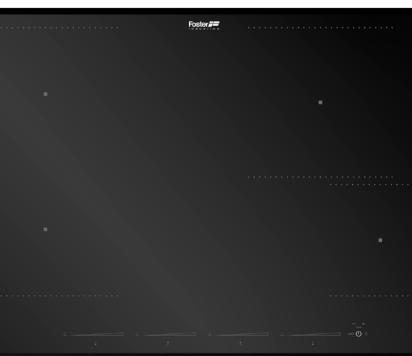

Cut-out
48 cm deep



7381 646  SF SF cut-out: 560 x 480
 FT FT cut-out: see website

- Dimensions: 580 x 510
- Finish: Black ceramic glass
- Electronic programming;
- 4 cooking zones with double extended Bridge zone
- 9 power settings per zone plus Powerboost function

Maximum power 1,500, 2,800, 3,500, 3,700, 4,500, 6,000, 7,400 W**
 2 x 210x190 mm 2,100 (3,000)* W
 ø 200 mm 2,300 (3,000)* W
 ø 145 mm 1,400 (1,850)* W

* Powerboost

Power supply: 230 - 380 V
50/60 Hz



Cut-out
48 cm deep



KE Induction

Code

Version

Characteristics

Price



NEW

7385 646



SF cut-out: 870 x 370



FT cut-out: see website

- Dimensions: 900 x 400
- Finish: Black ceramic glass
- Electronic programming;
- 5 cooking zones with double extended Bridge zone
- 9 power settings per zone plus Powerboost function

Maximum power 2,800, 3,500, 3,700, 4,500, 6,000, **7,400 W****
 4 x 210x190 mm 2,100 (3,000)* W

* Powerboost

Power supply: 230 - 380 V
 50/60 Hz



NEW

7386 646



SF cut-out: 750 x 480



FT cut-out: see website

- Dimensions: 810 x 520
- Finish: Black ceramic glass
- Electronic programming;
- 4 cooking zones with double extended Bridge zone
- 9 power settings per zone plus Powerboost function

Maximum power 2,800, 3,500, 3,700, 4,500, 6,000, 7,400, **10,400 W****
 4 x 210x190 mm 2,100 (3,000)* W
 ø 200 2,300 (3,000)* W

* Powerboost

Power supply: 230 - 380 V
 50/60 Hz



Cut-out
 48 cm deep



S4000 Domino Line



7330 255

SF

incasso SF: 810 x 330

FT

incasso FT: vedi sito web

- Dimensioni: 840 x 350
- Finitura: Vetroceramica nero
- Programmazione elettronica;
- 9 settaggi di potenza per zona più funzione doppio Powerboost

P. max assorbita 7.400 w
 sinistra \varnothing 260 mm 2.600 (3.600)* (3.700)** W
 centro 180x220 mm 2.100 (2.600)* (3.700)** W
 destra 180x220 mm 2.100 (2.600)* (3.700)** W

* Powerboost - ** Doppio Powerboost

Alimentazione: 230 - 380 V
 50/60 Hz



S4000 Domino Line

Codice	Versione	Caratteristiche	Prezzo
--------	----------	-----------------	--------

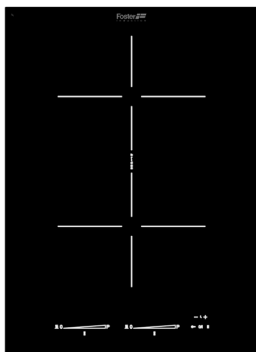

7341 655	Q4	incasso Q4: 350 x 490	
	FT	incasso FT: vedi sito web	

- Dimensioni: 380 x 520
- Finitura: Vetroceramica nero
- Programmazione elettronica
- 9 settaggi di potenza per zona più funzione doppio Powerboost

P. max assorbita 3.700 W
 2 zone con funzione Bridge
 180x220 mm 2.100 (2.600)* (3.700)** W

* Powerboost - ** doppio Powerboost

Alimentazione: 230 V
 50/60 Hz

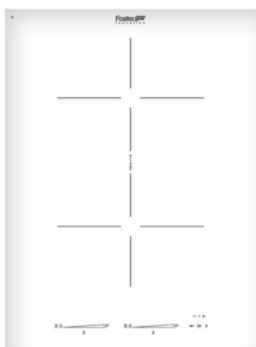

7341 255	Q4	incasso Q4: 350 x 490	
	FT	incasso FT: vedi sito web	

- Dimensioni: 380 x 520
- Finitura: Vetroceramica bianco
- Programmazione elettronica
- 9 settaggi di potenza per zona più funzione doppio Powerboost

P. max assorbita 3.700 W
 2 zone con funzione Bridge
 180x220 mm 2.100 (2.600)* (3.700)** W

* Powerboost - ** doppio Powerboost

Alimentazione: 230 V
 50/60 Hz



Teppan



7325 455	Q4	incasso Q4: 360 x 490	
-----------------	-----------	-----------------------	--

- Dimensioni: 380 x 520
- Finitura: Superficie in acciaio
- 2 zone cottura indipendenti A e B
- 9 livelli di potenza per zona
- Controllo elettronico della temperatura da 50° a 220° C
- Temperatura pre-impostate per: cottura carne, cottura pesce, pulizia

P. max assorbita 2.800 W
 2 zone cottura 2 x 1.400 W

Alimentazione: 230 V
 50/60 Hz



S4000 Domino Line

Codice

Versione

Caratteristiche

Prezzo

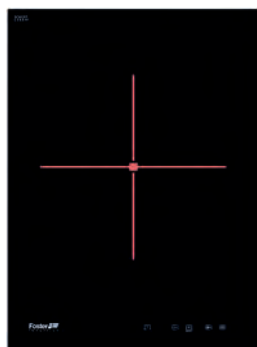

7321 240

Q4

incasso Q4: 350 x 490

FT

incasso FT: vedi sito web

- Dimensioni: 380 x 520
- Finitura: Vetroceramica nero
- Programmazione elettronica
- 9 settaggi di potenza per zona più funzione Powerboost

P. max assorbita 3.000 W
zona cottura ø 250 mm 2.300 (3.000)*

* Powerboost

Alimentazione: 230 V
50/60 Hz



7322 240

Q4

incasso Q4: 350 x 490

FT

incasso FT: vedi sito web

- Dimensioni: 380 x 520
- Finitura: Vetroceramica nero
- Programmazione elettronica
- 9 settaggi di potenza per zona più funzione Powerboost

P. max assorbita 3.700 W
superiore ø 200 mm 2.300 (3.000)*
inferiore ø 160 mm 1.200 (1.400)*

* Powerboost

Alimentazione: 230 V
50/60 Hz



Distanziere per piani Domino

8320 000



- Acciaio inox
- Dimensioni: **30x520** spessore: **4 mm**

Il distanziere in acciaio inox permette di creare un'unica superficie con i piani cottura domino aventi bordo verticale.

Il distanziere permette di aumentare lo spazio tra gli elementi della serie Domino e creare una pratica superficie d'appoggio.



Note per l'installazione in soluzione modulare continua



Installazione con fori d'incasso distinti

Per la corretta installazione in continuo va mantenuta una distanza di 20 mm tra i incassi dei prodotti (con eccezione di una distanza di 18 mm tra incasso cappa e altro prodotto). Per assicurare l'allineamento verticale dei prodotti si consiglia una profondità dell'incasso unica di 500 mm, indipendentemente dalla misura richiamata nel libretto (480, 490, 500 mm a seconda dei modelli).

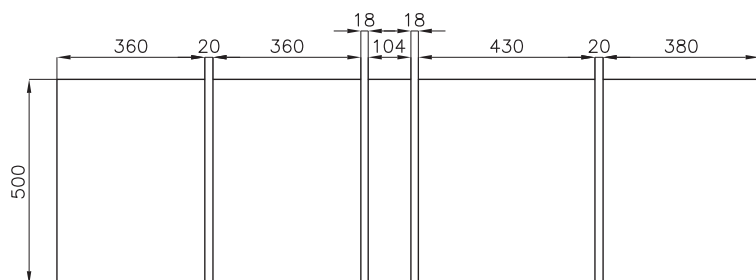

Installazione con unico foro d'incasso mediante l'utilizzo del distanziere

Con l'utilizzo dei distanzieri è possibile installare i prodotti in un unico foro da incasso, di 500 mm in profondità e in lunghezza pari alla somma delle dimensioni dei prodotti e dei distanzieri, diminuita di 20 mm. Nell'esempio riportato, da SX: $(380+30+380+30+120+30+450+30+400)$ mm-20 mm=1830 mm.

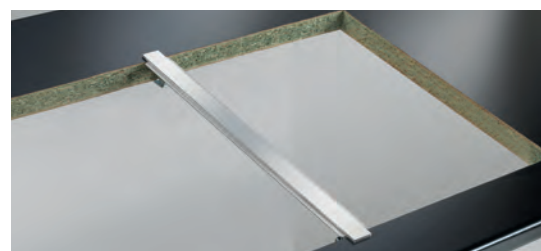
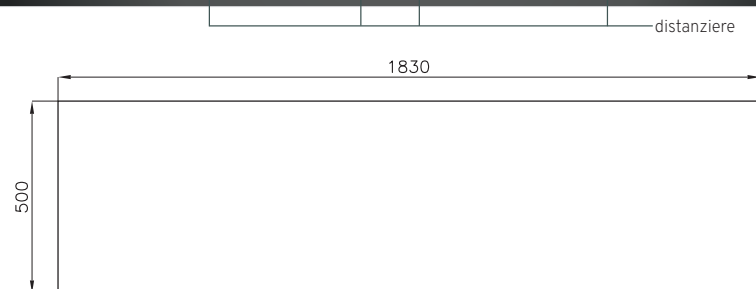

S4000 Domino si configura come incasso Q4, tuttavia, per vincoli progettuali, alcuni modelli hanno uno spessore leggermente maggiore. Questo comporta un piccolo scalino tra i prodotti nel caso di installazione in continuo: Teppan e cappa. Fare riferimento ai disegni dei singoli modelli, che riportano l'esatto spessore.

S1000



NEW

7374 300



incasso Q4: 810 x 330

incasso FT: vedi sito web

- Dimensioni: 840 x 350
- Finitura: Vetrocera mica nero
- Programmazione elettronica
- 9 settaggi di potenza per zona più funzione Powerboost

P. max assorbita 2.800, 3.500, 6.000, 6.600** W
sinistra \varnothing 240 mm 2.200 (3.000)*
centro \varnothing 145 mm 1.200 (1.600)*
destra \varnothing 210 mm 1.500 (2.000)*

* Powerboost

Alimentazione: 230 - 380 V
50/60 Hz



7371 300



incasso Q4: 740 x 480

incasso FT: vedi sito web

- Dimensioni: 770 x 510
- Finitura: Vetrocera mica nero
- Programmazione elettronica
- 9 settaggi di potenza per zona più funzione Powerboost

P. max assorbita 2.800, 3.500, 6.000, **7.200** W**
sinistra \varnothing 210 mm 1.500 (2.000)*
sinistra sup. \varnothing 145 mm 1.200 (1.600)*
destra \varnothing 145 mm 1.200 (1.600)*
destra sup. \varnothing 210 mm 1.500 (2.000)*

* Powerboost

Alimentazione: 230 - 380 V
50/60 Hz



Foro incasso
profondità 48 cm



S1000

Codice

Versione

Caratteristiche

Prezzo



Alimentazione: 230 - 380 V
50/60 Hz



Foro incasso
profondità 48 cm

7370 300

Q4

incasso Q4: 560 x 480

FT

incasso FT: vedi sito web

- Dimensioni: 580 x 510
- Finitura: Vetrocera mica nero
- Programmazione elettronica
- 9 settaggi di potenza per zona più funzione Powerboost

P. max assorbita 2.800, 3.500, 6.000, **7.200**W**
sinistra ø 210 mm 1.500 (2.000)*
sinistra sup. ø 145 mm 1.200 (1.600)*
destra ø 145 mm 1.200 (1.600)*
destra sup. ø 210 mm 1.500 (2.000)*

* Powerboost



Alimentazione: 230 - 380 V
50/60 Hz

7373 300

Q4

incasso Q4: 420 x 485

FT

incasso FT: vedi sito web

- Dimensioni: 440 x 500
- Finitura: Vetrocera mica nero
- Programmazione elettronica
- 9 settaggi di potenza per zona più funzione Powerboost

P. max assorbita 1.500, 2.200, 2.800, 3.400, **5.200 W**
sinistra sup. ø 145 mm 1.200 (1.600)*
sinistra inf. ø 210 mm 1.500 (2.000)*
destra ø 145 mm 1.200 (1.600)*

* Powerboost



Alimentazione: 230 - 380 V
50/60 Hz

7322 300

Q4

incasso Q4: 270 x 490

FT

incasso FT: vedi sito web

- Dimensioni: 290 x 510
- Finitura: Vetrocera mica nero
- Programmazione elettronica
- 9 settaggi di potenza per zona più funzione Powerboost

P. max assorbita **3.700 W**
superiore ø 200 mm 2.300 (3.000)*
inferiore ø 160 mm 1.400

* Powerboost



Serie Modular Induction & Modular Quadra



Connessione del sistema Modular

Disposizione degli elementi

Il sistema Modular permette la libera disposizione dei suoi elementi. L'unico limite è dato dalla lunghezza dei cavi che collegano gli elementi con il box di connessione: **60 cm per il modulo touch e 90 cm per le zone di cottura.**

Combinazioni zone cottura

Il piano può essere composto in piena libertà; alcune combinazioni di piastre non compatibili sono segnalate tra le note dei Moduli Touch control.

Box di connessione

L'installazione è immediata e intuitiva. Il box può essere posto a muro dietro al cabinet o all'interno di esso, sotto al piano cottura.

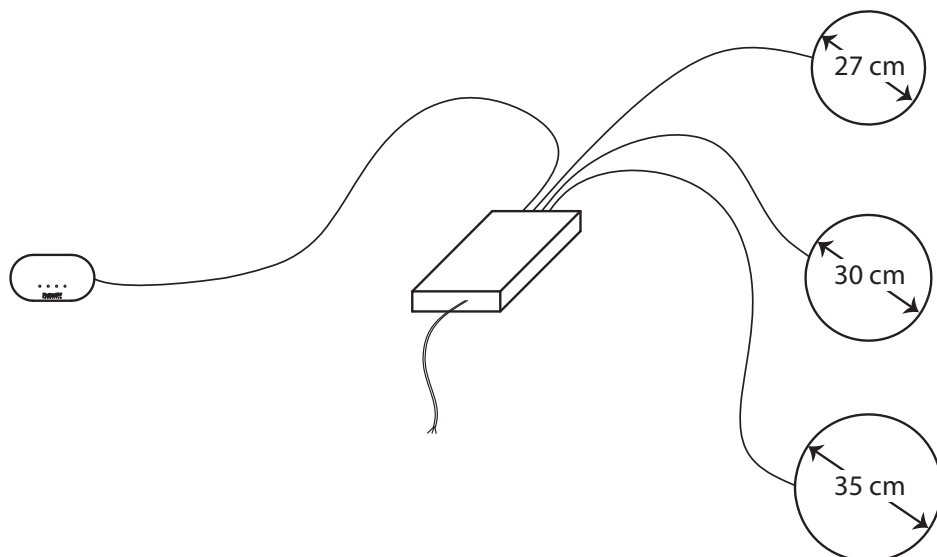

Serie Modular Induction & Modular Quadra

Massima libertà

Modular Induction è la nuova proposta Foster che vi permette la piena libertà di comporre il vostro piano ad induzione in base allo spazio disponibile e alle specifiche esigenze.

Infinite possibilità

I tre modelli di piastra, differenti per diametro e potenza, possono essere posizionati con grande flessibilità in combinazioni di due, tre o quattro zone controllate dai rispettivi pannelli touch control.

Installazione intuitiva

L'installazione è semplice e immediata grazie al box di connessione, facilmente posizionabile nel sottopiano, che collega le piastre al touch control.

Coordinato al vostro stile

Modular Induction, disponibile con design tondo o quadrato si adatta perfettamente allo stile della vostra cucina.



Serie Modular Induction



- Pannello Touch control
- Programmazione elettronica indipendente delle zone di cottura
- 9 settaggi di potenza per zona più funzione Powerboost

Da ordinare con relativo box di connessione
Lunghezza cavo di connessione: 60 cm

Nota: il Touch control Modular necessita di una semplice configurazione, in funzione della combinazione di piastre associate, come indicato nel manuale di installazione.

Alimentazione: 230 - 380 V
50/60 Hz



Serie Modular Induction

Codice

Versione

Caratteristiche

Prezzo

Touch control per 4 zone



Dimensioni: 275 x 150 R75

7368 040

Q4

Incasso Q4: vedi sito web

+ box di
connessione

FT

Incasso FT: vedi sito web

7369 040

Combinazioni zone cottura collegabili:

- 2 zone 7361 270

- 2 zone libere (qualsiasi modello)

Touch control per 3 zone



Dimensioni: 275 x 150 R75

7368 030

Q4

Incasso Q4: vedi sito web

+ box di
connessione

FT

Incasso FT: vedi sito web

7369 030

Combinazioni zone cottura collegabili:

- 1 zona 7361 270

- 2 zone libere (qualsiasi modello)

Touch control per 2 zone



Dimensioni: 275 x 150 R75

7368 020

Q4

Incasso Q4: vedi sito web

+ box di
connessione

FT

Incasso FT: vedi sito web

7369 020

Combinazioni zone cottura collegabili:

- 2 zone libere (qualsiasi modello)

Zona induzione Ø 350 mm

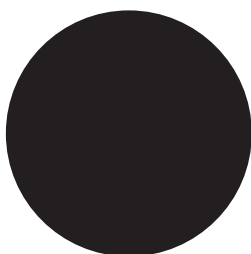

7363 350

Q4

Incasso Q4: Ø 334

FT

Incasso FT: vedi sito web

P. max assorbita
2.300 (3.000)* W
* Powerboost

Zona induzione Ø 300 mm

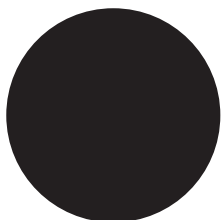

7362 300

Q4

Incasso Q4: Ø 284

FT

Incasso FT: vedi sito web

P. max assorbita
2.300 (3.000)* W
* Powerboost

Zona induzione Ø 270 mm

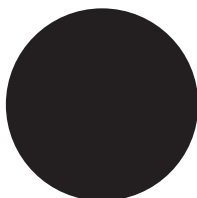

7361 270

Q4

Incasso Q4: Ø 254

FT

Incasso FT: vedi sito web

P. max assorbita
1.100 (1.400)* W
* Powerboost

Serie Modular Quadra



- Pannello Touch control
- Programmazione elettronica indipendente delle zone di cottura
- 9 settaggi di potenza per zona più funzione Powerboost

Da ordinare con relativo box di connessione
Lunghezza cavo di connessione: 60 cm

Nota: il Touch control Modular necessita di una semplice configurazione, in funzione della combinazione di piastre associate, come indicato nel manuale di installazione.

Alimentazione: 230 - 380 V
50/60 Hz



Serie Modular Quadra

Codice

Versione

Caratteristiche

Prezzo

Touch control per 4 zone



Dimensioni: 275 x 150 R5

7367 040



Incasso SF: 265 x 140

+ box di
connessione



Incasso FT: vedi sito web

7369 040

Combinazioni zone cottura collegabili:

- 2 zone 7364 270

- 2 zone libere (qualsiasi modello)

Touch control per 3 zone



Dimensioni: 275 x 150 R5

7367 030



Incasso SF: 265 x 140

+ box di
connessione



Incasso FT: vedi sito web

7369 030

Combinazioni zone cottura collegabili:

- 1 zona 7364 270

- 2 zone libere (qualsiasi modello)

Touch control per 2 zone



Dimensioni: 275 x 150 R5

7367 020



Incasso SF: 265 x 140

+ box di
connessione



Incasso FT: vedi sito web

7369 020

Combinazioni zone cottura collegabili:

- 2 zone libere (qualsiasi modello)

Zona induzione 350 x 350 mm



7366 350



Incasso SF: 334 x 334

Foro incasso:
vedi sito web



Incasso FT: vedi sito web

P. max assorbita
2.300 (3.000)* W
* Powerboost

Zona induzione 300 x 300 mm



7365 300



Incasso SF: 284 x 284

Foro incasso:
vedi sito web



Incasso FT: vedi sito web

P. max assorbita
2.300 (3.000)* W
* Powerboost

Zona induzione 270 x 270 mm



7364 270



Incasso SF: 254 x 254

Foro incasso:
vedi sito web



Incasso FT: vedi sito web

P. max assorbita
1.100 (1.400)* W
* Powerboost

Configurazioni Serie Modular Induction

Codice

Prezzo

Gli articoli sotto riportati rappresentano alcune nostre proposte già configurate, e non escludono la possibilità di altre combinazioni di piastre.

La disposizione degli elementi sul top rimane libera, con i vincoli riportati alla sezione "Connessione del Sistema Modular Induction" (Pag. 384).

4 zone



1 Touch control
1 box di connessione
2 zone Ø 300 mm
2 zone Ø 270 mm

7366 040

3 zone

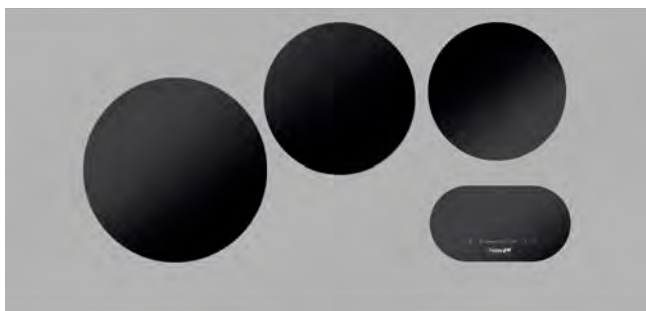

1 Touch control
1 box di connessione
1 zona Ø 350 mm
1 zona Ø 300 mm
1 zona Ø 270 mm

7366 030

2 zone



1 Touch control
1 box di connessione
1 zona Ø 350 mm
1 zona Ø 270 mm

7366 020



Configurazioni Serie Modular Quadra

Codice

Prezzo

Gli articoli sotto riportati rappresentano alcune nostre proposte già configurate, e non escludono la possibilità di altre combinazioni di piastre. La disposizione degli elementi sul top rimane libera, con i vincoli riportati alla sezione "Connessione del Sistema Modular Induction" (Pag. 384).

4 zone

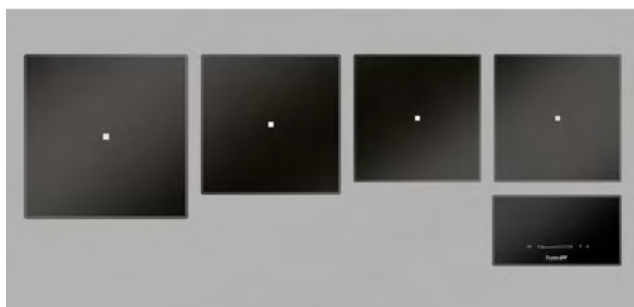

1 Touch control
1 box di connessione
1 zona 300 x 300 mm
2 zone 270 x 270 mm
1 zona 350 x 350 mm

7365 040

3 zone

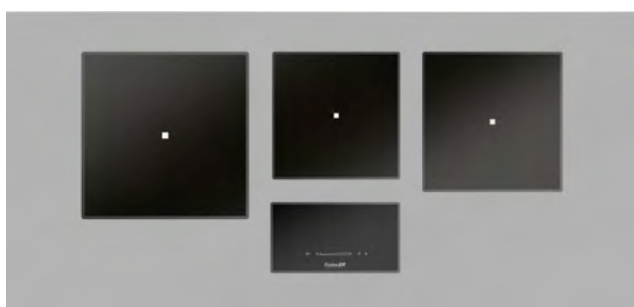

1 Touch control
1 box di connessione
1 zona 350 x 350 mm
1 zona 300 x 300 mm
1 zona 270 x 270 mm

7365 030

2 zone



1 Touch control
1 box di connessione
1 zona 350 x 350 mm
1 zona 270 x 350 mm

7365 020



KE Arya Black **NEW**

7392 246

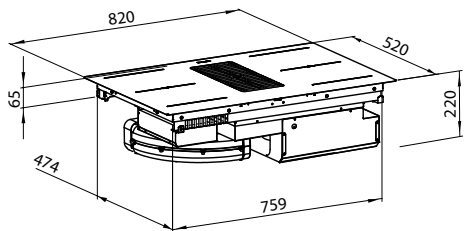

Foster Milano Air

7391 245

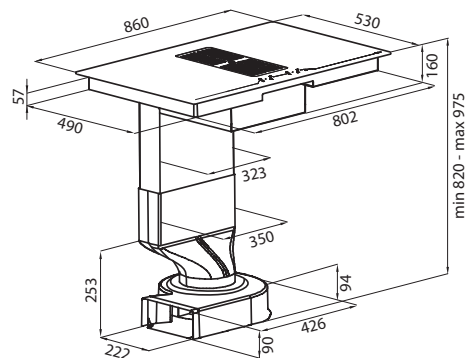

KE Induction

7384 646

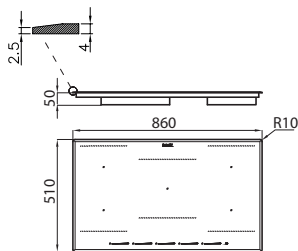

7382 646

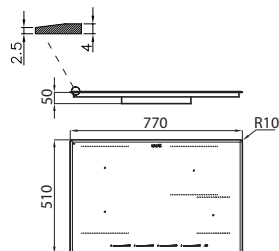

7381 646

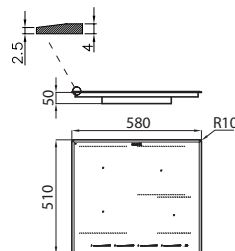

7385 646 **NEW**

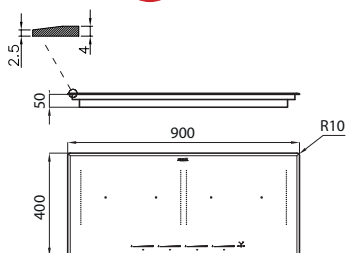

7386 646 **NEW**

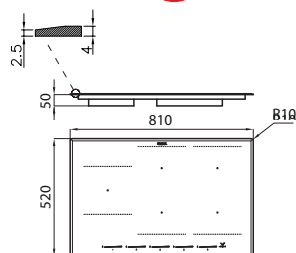

S4000 Domino Line

7330 255

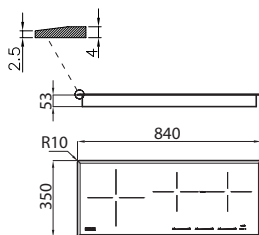

7341 655

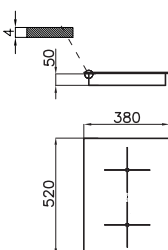

7341 255

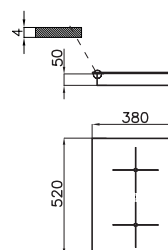

7325 455

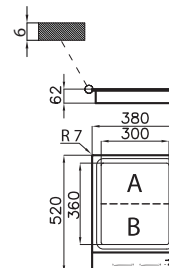

S4000 Domino Line

7321 240

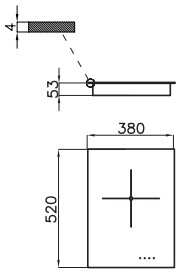

7322 240

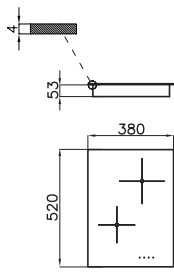

S1000

7374 300

NEW

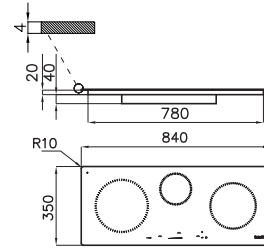

7371 300

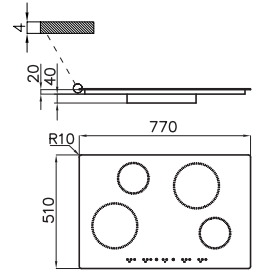

S1000

7370 300

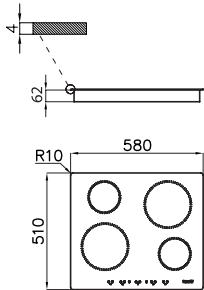

7373 300

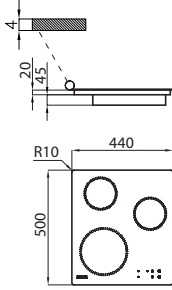

7322 300

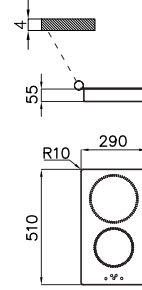

Serie Modular Induction

7368 040
7368 030
7368 020

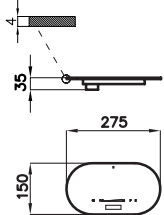

7369 040
7369 030
7369 020

Box di connessione

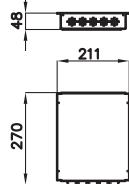

7363 350

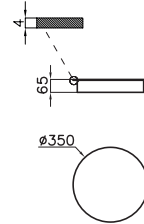

7362 300

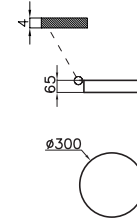

7361 270

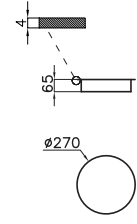

Serie Modular Quadra

7367 040
7367 030
7367 020

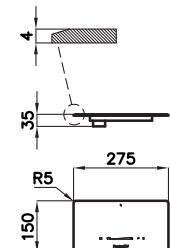

7369 040
7369 030
7369 020

Box di connessione

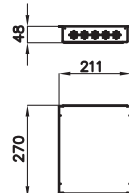

7366 350

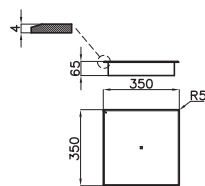

7365 300

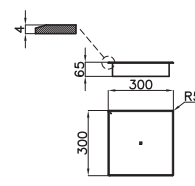

7364 270

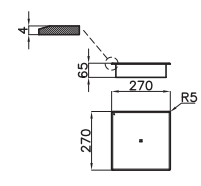

Gas hobs







402	Milanello 5F
404	Milanello
406	Milano <small>NEW</small>
408	S4000
410	S4000 Domino
412	S4000 Line
414	Quadra Angolare
416	FL
418	KE
421	KF <small>NEW</small>
422	Veronika
424	Angolare
426	Power <small>NEW</small>
428	Power Glass <small>NEW</small>



Gas hobs

Nature / Technology

Energy saving
with the highest efficiency

Utmost safety
thanks to safety valves

which immediately shut off the gas supply if the flame accidentally goes out

High performance burners
that ensure significant energy savings



High Efficiency Burners (AEO):
5 kW and gas savings of 25%

The new AEO burners (high efficiency) have a maximum efficiency of 69%, the DUAL AEO burner reaches a maximum power of 5 kW. The brass flame-spreader ring gives it a professional look.



III Series burners:
20% gas savings

They guarantee an efficiency well above the European standards. The locking system between the cover and the flame spreader guarantees perfect positioning and greater ease of cleaning.



Dual burners:
performance and versatility, from 300 to 4,500 W
Innovative and versatile burner, with three fire crowns with independent ignition operated by a single knob. It is capable of delivering power from 300 to 4,500 W.



Flat burners
Efficiency above standards with ultra-flat look.

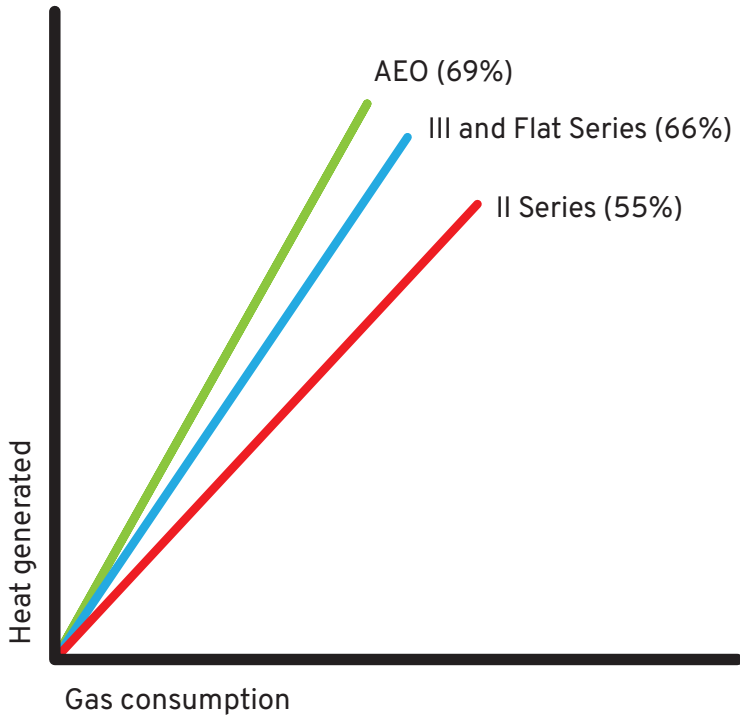

The versatility of Dual burners
Highest functionality due to the three fire crowns.

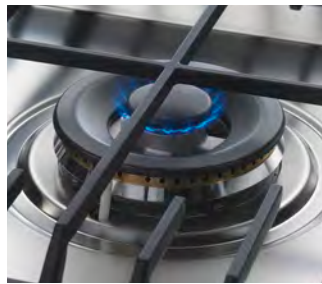

Cast iron grids



High heat capacity
that improves performance

Sturdiness and stability
that improve safety

Elegant in their linearity
and standard supplied with every hob

Gas hobs



Ultra-flat

The grids form a surface that allows pots to be moved from one burner to another.

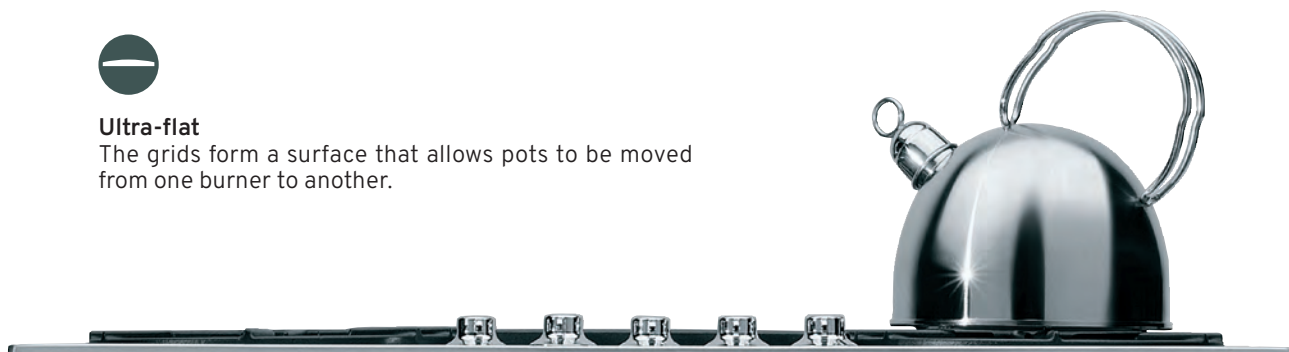

Deep recess

The depth of the recessed burners areas improves the sturdiness and professionalism of the hob while still ensuring easy cleaning even around the edges.



Precise Power

Maximum precision in regulating the flame, thanks to the 10 pre-set levels of the Precise Power system



Cast iron surface

The hob has cast iron accessories that increase the support surface.



Metal knob

The sturdy metal knob not only makes the hob look professional, but it also adds elegance and functionality.



XXL grid

The XXL grid has extraordinary dimensions that provide a large support surface even for large pots.

Gas hobs | Characteristics

As well as built-in... how and where you want it
Foster offers a remarkable and comprehensive range of insertion systems.



STD

Standard

Traditional installation with the edge that protrudes from the worktop by 8 mm.



Q4

Q4

Installation with squared profile and an overhang from the worktop of only 4 mm.



SF

Flat edge

Sloping edge which protrudes just 3 mm from the worktop. Elegant and easy to install.



FT SPT

Flush-mount

It fits into a drop-down in the worktop and is perfectly flush. Alternatively, it fits into a recess in the worktop.

All Foster hobs are tested with natural gas; LPG Gas nozzles are also supplied as spares with the hob.

Gas hobs | Accessories



1 Wok support
9601 668



2 Wok support
9601 727



3 Cast iron pot support
9601 742



4 Cast iron pot support
9601 741

Milanello 5F

top-mount | flush-mount

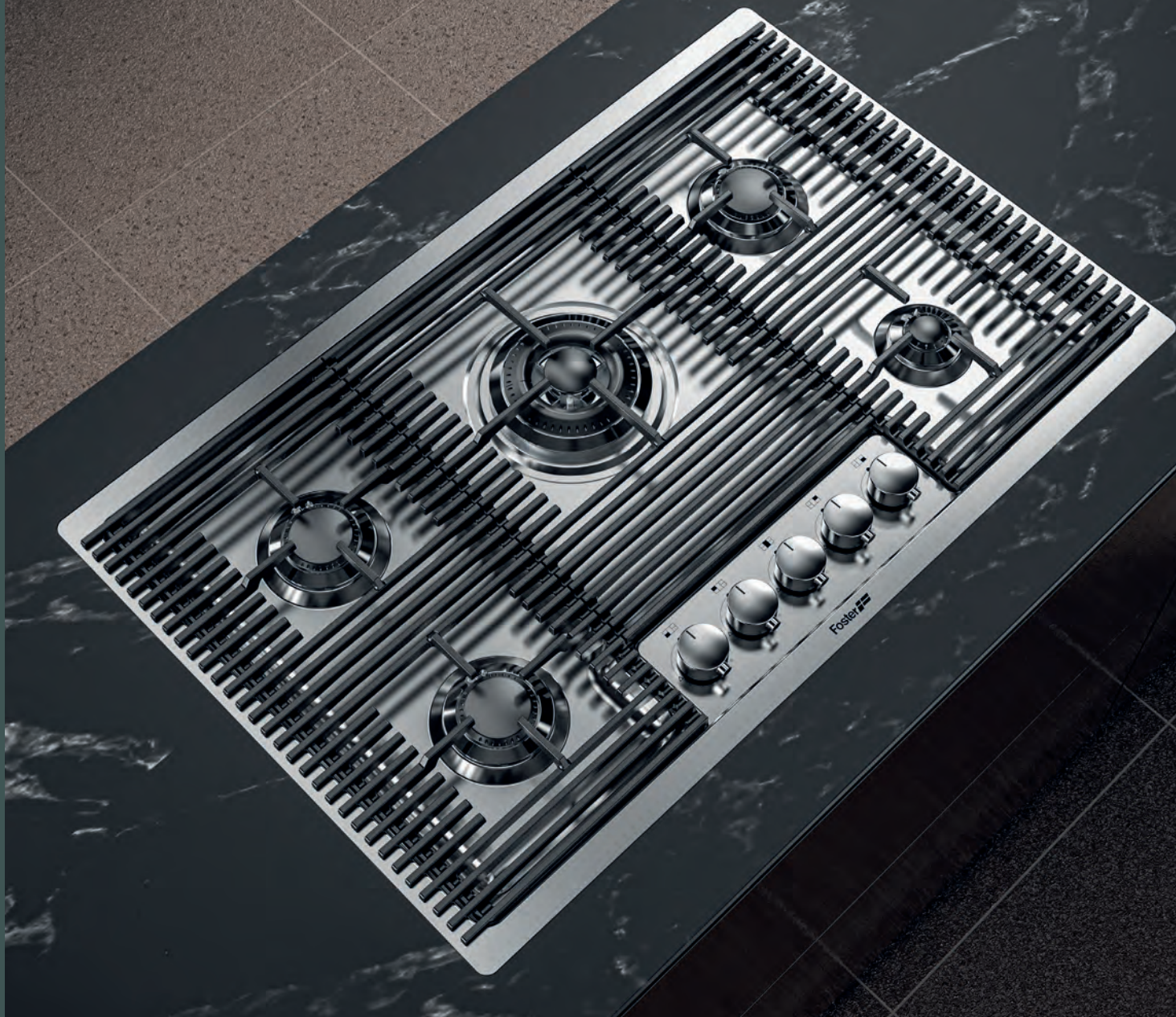

Accessories: **2** (see page 401)

Code	Version	Characteristics	Price
------	---------	-----------------	-------

7682 000

FT

FT cut-out: see website

SPT

SPT cut-out: 790x500

- Satin finish AISI 304
- Dimensions: **803 x 513**
- Cast iron grids and enamelled burner covers
- Electric ignition

- Safety valve with ultra-rapid thermocouples
- Total power 10,250 W auxiliary: 1,000 W semirapid: 3x1,750 W double crown: 4,000 W

• Also available in version **PVD**

Gun Metal
7682 006



page 40

Copper
7682 008



page 58

Gold
7682 009



page 76

**Precise Power:
Great control in flame settings**

- 10 power levels
- Maximum precision in regulating the flame
- Ultra-flat look

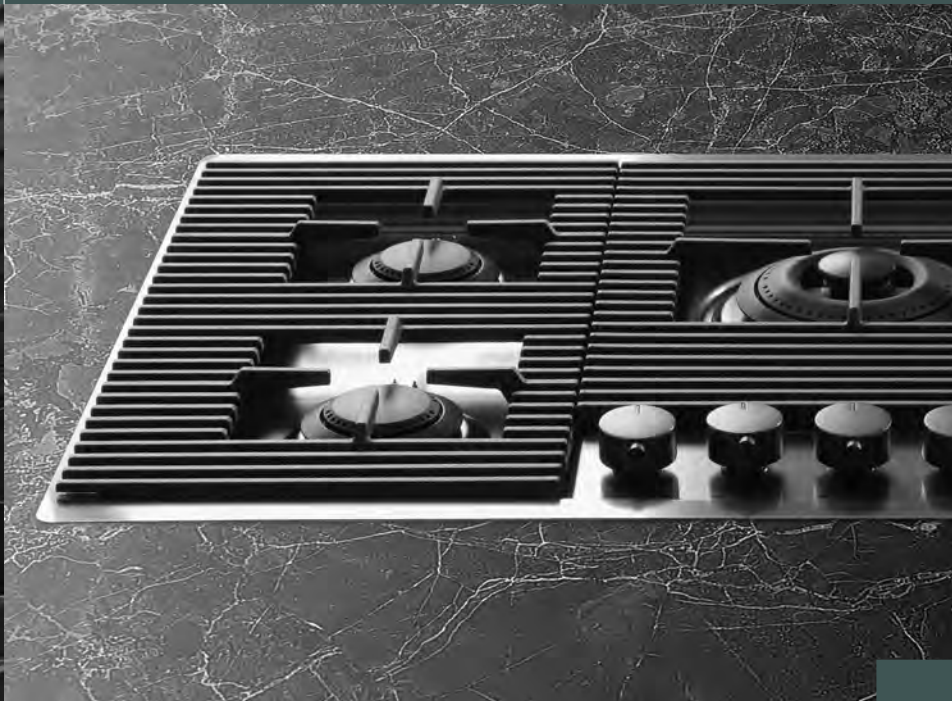

Milanello
top-mount |
flush-mount



Milanello

top-mount | flush-mount



Accessories: 2 (see page 401)

Code	Version	Characteristics	Price
------	---------	-----------------	-------

7681 000	FT	FT cut-out: see website	
	SPT	SPT cut-out: 1098X459	

- Satin finish AISI 304
- Dimensions: **1115 x 476**
- Cast iron grids and enamelled burner covers
- Electric ignition
- Safety valve with ultra-rapid thermocouple
- Total power 10,750 W
auxiliary: 1,000 W
semirapid: 1,750 W
rapid: 3,000 W
dual: 5,000 W

• Also available in version **PVD**

Gun Metal
7681 006



page 40

Copper
7681 008



page 58

Gold
7681 009



page 76

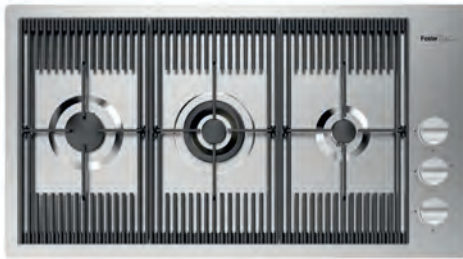

Accessories: 2 (see page 401)

7680 000	FT	FT cut-out:: see website	
	SPT	SPT cut-out:: 853x459	

- Satin finish AISI 304
- Dimensions: **870 x 476**
- Cast iron grids and enamelled burner covers
- Electric ignition
- Safety valve with ultra-rapid thermocouple
- Total power 7,750 W
auxiliary: 1,000 W
semirapid: 1,750 W
dual: 5,000 W

• Also available in version **PVD**

Gun Metal
7680 006



page 40

Copper
7680 008



page 58

Gold
7680 009



page 76



Milano **NEW**

top-mount | flush-mount



Included: 2 **2** (see page 401)

Code	Version	Characteristics	Price
7639 000	FT	FT cut-out: see website	
	SPT	SPT cut-out: 1134x540	

- Satin finish AISI 304
- Dimensions: **1154x560**
- Cast iron grids and enamelled burner covers
- Electric ignition
- Safety valve with ultra-rapid thermocouples

- Total power 15,900 W
- auxiliary: 1,000 W
- semirapid: 2x1,750 W
- rapid: 3,000 W
- dual: 2x4,200 W

• Also available in version **PVD**

Gun Metal
7639 006



page 41

Copper
7639 008



page 59

Gold
7639 009



page 77

Milano NEW

top-mount | flush-mount



Included: 2 (see page 401)

Code	Version	Characteristics	Price
7638 000	FT	FT cut-out: see website	
	SPT	SPT cut-out: 1036x540	

- Satin finish AISI 304
- Dimensions: **1056x560**
- Cast iron grids and enamelled burner covers
- Electric ignition
- Safety valve with ultra-rapid thermocouple
- Total power 10,950 W
auxiliary: 2x1,000 W
semirapid: 1,750 W
rapid: 3,000 W
dual: 4,200 W

• Also available in version **PVD**

Gun Metal
7638 006



page 41

Copper
7638 008



page 59

Gold
7638 009



page 77



Included: 2 (see page 401)

7637 000	FT	FT cut-out: see website
	SPT	SPT cut-out: 800x540

- Satin finish AISI 304
- Dimensions: **820x560**
- Cast iron grids and enamelled burner covers
- Electric ignition
- Safety valve with ultra-rapid thermocouple
- Total power 9,950 W
auxiliary: 1,000 W
semirapid: 1,750 W
rapid: 3,000 W
dual: 4,200 W



Included: 2 (see page 401)

7640 000	FT	FT cut-out: see website
	SPT	SPT cut-out: 1060x470

- Satin finish AISI 304
- Dimensions: **1080x490**
- Cast iron grids and enamelled burner covers
- Electric ignition
- Safety valve with ultra-rapid thermocouple
- Total power 9,950 W
auxiliary: 1,000 W
semirapid: 1,750 W
rapid: 3,000 W
dual: 4,200 W

• Also available in version **PVD**

Gun Metal
7640 006



page 41

Copper
7640 008



page 59

Gold
7640 009



page 77

S4000

top-mount | flush-mount



Q4



S4000

top-mount | flush-mount



Code	Version	Characteristics	Price
------	---------	-----------------	-------

7257 032	 FT	FT cut-out: see website	
	 SPT	SPT cut-out: 900x500	



Included: **1** | Flush-Mount Accessories: **3** (see page 401)



- Satin finish AISI 304
 - Dimensions: **920x520**
 - Cast iron grids and enamelled burner covers
 - Electric ignition
 - Safety valve with ultra-rapid thermocouple
- Total power 11,400 W
auxiliary: 1,100 W
semirapid: 2x1,750 W
rapid: 3,000 W
triple crown: 3,800 W

7271 032	 FT	FT cut-out: see website	
	 SPT	SPT cut-out: 900x500	



Included: **1** | Flush-Mount Accessories: **3** (see page 401)

- Satin finish AISI 304
 - Dimensions: **920x520**
 - Cast iron grids and enamelled burner covers
 - Electric ignition
 - Safety valve with ultra-rapid thermocouple
- Total power 11,400 W
auxiliary: 1,100 W
semirapid: 2x1,750 W
rapid: 3,000 W
triple crown: 3,800 W

7256 032	 FT	FT cut-out: see website	
	 SPT	SPT cut-out: 600x500	



Flush-mount Accessories: **3** (see page 401)

- Satin finish AISI 304
 - Dimensions: **620x520**
 - Cast iron grids and enamelled burner covers
 - Electric ignition
 - Safety valve with ultra-rapid thermocouple
- Total power 7,600 W
auxiliary: 1,100 W
semirapid: 2x1,750 W
rapid: 3,000 W

S4000 Domino

Q4

Code

Version

Characteristics

Price

7278 032



04

cut-out: 430x480

- Satin finish AISI 304
- Dimensions: **450x520**
- Cast iron grids and enamelled burner covers
- Electric ignition
- Safety valve with ultra-rapid thermocouple
- Total power 5,000 W
dual AE: 5,000 W



Included: **2**, **3** (see page 401)

Fixing notes on the opposite page

Provision for Asian markets on request

7276 032



04

cut-out: 360x480

- Satin finish AISI 304
- Dimensions: **380x520**
- Cast iron grids and enamelled burner covers
- Electric ignition
- Safety valve with ultra-rapid thermocouple
- Total power 2,750 W
auxiliary AE: 1,000 W
semirapid AE: 1,750 W



Included: **3** (see page 401)

Fixing notes on the opposite page

A versatile pot support

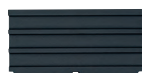

In flush-mount versions, the pot support code 9601 742 is available as an accessory, which extends the work surface while protecting the worktop from accidental contact with hot pots. Standard for S4000 Domino versions.



S4000 Domino

Code

Price

Spacer for Domino worktops

8320 000



- Stainless steel
- Dimensions: **30x520** thickness: **4 mm**

The stainless steel spacer can be used to create a single surface with Domino hobs with a vertical edge.

The spacer allows you to increase the space between Domino series elements and create a handy support surface.



Notes for installation in a seamless modular solution



Installation with individual cut-outs

For correct seamless installation, a distance of 20 mm must be kept between product cut-outs (except for 18 mm between the hood recess and that of another product). To ensure vertical alignment of the products, we recommend a single recess depth of 500 mm, regardless of the size given in the manual (480, 490, 500 mm depending on the model).

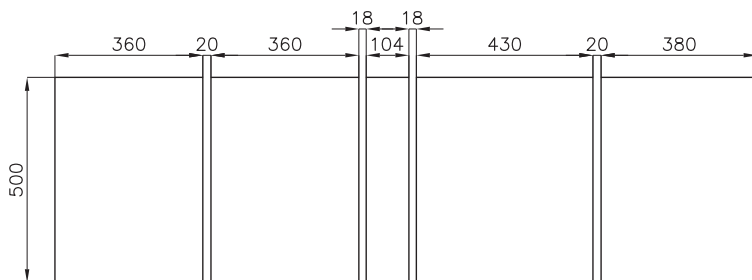

Installation with just one cut-out using the spacer

With spacers, products can be installed in just one cut-out, 500 mm deep and as long as the sum of the dimensions of the products and spacers, minus 20 mm. In the example shown, from the left: $(380+30+380+30+120+30+450+30+400)$ mm - 20 mm = 1830 mm.

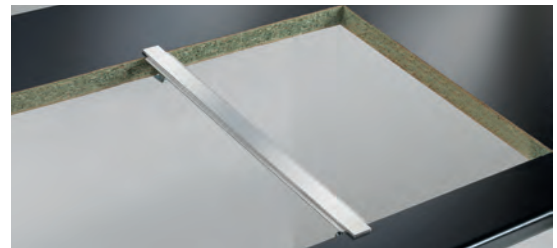
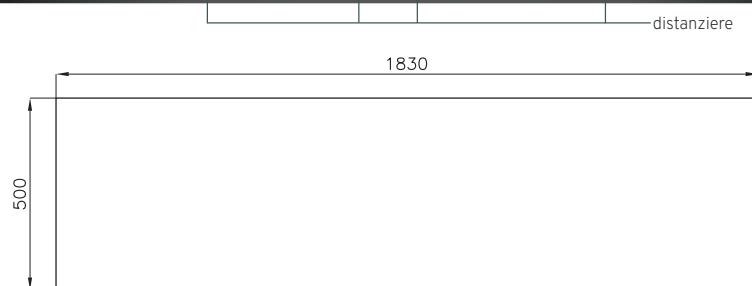



S4000 Domino is configured as a Q4 installation, however, due to design constraints, some models have a slightly superior thickness. This results in a small step between the products in a seamless installation: Teppan and hood. Refer to the drawings of the individual models, which show the exact thickness.

S4000 Line

top-mount | flush-mount



Code	Version	Characteristics	Price
7284 042	 FT	FT cut-out: see website	
	 SPT	SPT cut-out: 1162x448	



- Satin finish AISI 304
- Dimensions: **1179x465**
- Cast iron grids and enamelled burner covers
- Electric ignition
- Safety valve with ultra-rapid thermocouple
- Total power 9,650 W
auxiliary: 1,100 W
semirapid: 1,750 W
rapid: 3,000 W
triple crown: 3,800 W



Included: 4  , 1  (see page 401)

S4000 Line

top-mount | flush-mount



Included: 3 **4**, **1** (see page 401)

Code	Version	Characteristics	Price
------	---------	-----------------	-------

7285 032	FT	FT cut-out: see website	
	SPT	SPT cut-out: 908x448	

- Satin finish AISI 304
- Dimensions: **925x465**
- Cast iron grids and enamelled burner covers
- Electric ignition
- Safety valve with ultra-rapid thermocouple
- Total power 6,650 W
auxiliary: 1,100 W
semirapid: 1,750 W
triple crown: 3,800 W



Included: **1** | Accessories: **4** (see page 401)

7259 042	FT	FT cut-out: see website	
	SPT	SPT cut-out: 1162x351	

- Satin finish AISI 304
- Dimensions: **1179x368**
- Cast iron grids and enamelled burner covers
- Electric ignition
- Safety valve with ultra-rapid thermocouple
- Total power 9,650 W
auxiliary: 1,100 W
semirapid: 1,750 W
rapid: 3,000 W
triple crown: 3,800 W



Included: **1** | Accessories: **4** (see page 401)

7286 032	FT	FT cut-out: see website	
	SPT	SPT cut-out: 1060x470	

- Satin finish AISI 304
- Dimensions: **1080x490**
- Cast iron grids and enamelled burner covers
- Electric ignition
- Safety valve with ultra-rapid thermocouple
- Total power 6,650 W
auxiliary: 1,100 W
semirapid: 1,750 W
triple crown: 3,800 W

Quadra Angolare

top-mount | flush-mount

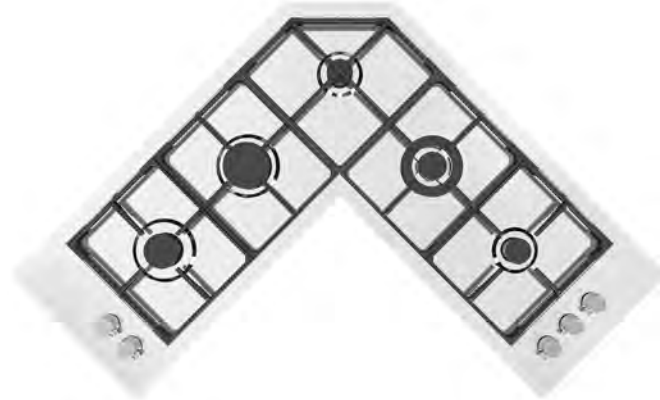

Included: 1 (see page 401)

Code	Version	Characteristics	Price
7238 042	FT	FT cut-out: see website	
	SPT	SPT cut-out: see website	

- Satin finish AISI 304
- Dimensions: **972x972**
- Cast iron grids and enamelled burner covers
- Electric ignition
- Safety valve with ultra-rapid thermocouple

- Total power 9,950 W
- auxiliary: 2x1,000 W
- semirapid: 1,750 W
- rapid: 2,700 W
- triple crown: 3,500 W

Connection to the gas network must be made via the two inlets to the gas manifold of the knobs.







The smart corner

With a large front work surface, the Quadra Angolare hob makes the best use of the kitchen corner.

FL
top-mount | flush-mount |
standard



Included: 2 (see page 401)

Code	Version	Characteristics	Price
7201 032	 STD	Standard: 860x500 cut-out: 840x480	
7206 032	 FT  SPT	Flush-mount: 873x513 cut-out: see website cut-out: 860x500	
7206 082 Vintage finish			

- Satin finish AISI 304
- Cast iron grids and enamelled burner covers
- Safety valve with ultra-rapid thermocouple
- Electric ignition
- Total power 10,500 W
auxiliary: 2x1,000 W
dual AE: 5,000 W
semirapid: 2x1,750 W

FL

top-mount | flush-mount | standard

Code

Version

Characteristics

Price

7203 032

 **STD**

cut-out: 740x480



Included: 2  (see page 401)

- Satin finish AISI 304
- Dimensions: **760x500**
- Cast iron grids and enamelled burner covers
- Electric ignition
- Safety valve with ultra-rapid thermocouple

- Total power 10,000 W dual AE: 2x5,000 W

7208 032

 **FT**

FT cut-out: see website

 **SPT**

SPT cut-out: 340x500



- Satin finish AISI 304
- Dimensions: **353x513**
- Cast iron grids and enamelled burner covers
- Electric ignition
- Safety valve with ultra-rapid thermocouple

- Total power 2,750 W auxiliary: 1,000 W semirapid: 1,750 W

7207 032

 **FT**

FT cut-out: see website

 **SPT**

SPT cut-out: 340x500



Included: 2  (see page 401)

- Satin finish AISI 304
- Dimensions: **353x513**
- Cast iron grids and enamelled burner covers
- Electric ignition
- Safety valve with ultra-rapid thermocouple

- Total power 5,000 W dual AE: 5,000 W

KE

top-mount | flush-mount |
standard



KE

top-mount | flush-mount | standard



Accessories: 2 (see page 401)

Code

Version

Characteristics

Price

7603 032



cut-out: 840x480

- Satin finish AISI 304
- Dimensions: **860x500**
- Cast iron grids and enamelled burner covers
- Electric ignition
- Safety valve with ultra-rapid thermocouple
- Total power 9,500 W
auxiliary: 2x1,100 W
semirapid: 2x1,750 W
triple crown: 3,800 W



Accessories: 2 (see page 401)

7602 032



cut-out: 750x480

Can be installed on bases measuring 75

- Satin finish AISI 304
- Dimensions: **790x500**
- Cast iron grids and enamelled burner covers
- Electric ignition
- Safety valve with ultra-rapid thermocouple
- Total power 9,500 W
auxiliary: 2x1,100 W
semirapid: 2x1,750 W
triple crown: 3,800 W



Accessories: 2 (see page 401)

7600 032



Flat edge: 803x513

cut-out: 770x480

- Satin finish AISI 304
- Dimensions: **803x513**
- Cast iron grids and enamelled burner covers
- Electric ignition
- Safety valve with ultra-rapid thermocouple
- Total power 9,500 W
auxiliary: 2x1,100 W
semirapid: 2x1,750 W
triple crown: 3,800 W

KE

top-mount | flush-mount | standard



Accessories: **2** (see page 401)

Code

Version

Characteristics

Price

7601 032

FT

FT cut-out: see website

SPT

SPT cut-out: 790x500

- Satin finish AISI 304
 - Dimensions: **803x513**
 - Cast iron grids and enamelled burner covers
 - Electric ignition
 - Safety valve with ultra-rapid thermocouple
 - Total power 9,500 W
auxiliary: 2x1,100 W
semirapid: 2x1,750 W
triple crown: 3,800
- Also available in version **PVD**

Gun Metal
7601 632



page 42

Copper
7601 866



page 60

Gold
7601 932



page 78



KF **NEW**
standard



This model cannot be welded in stainless steel worktops

Accessories: **2** (see page 401)

Code	Version	Characteristics	Price
7666 062	 STD	cut-out: 560x480	

- Satin finish AISI 304
- Dimensions: **760x500**
- Cast iron grids and enamelled burner covers
- Electric ignition
- Safety valve with ultra-rapid thermocouple

- Total power 10,700 W
- auxiliary: 1,000 W
- semirapid: 2x1,750 W
- rapid: 2,700 W
- triple crown: 3,500 W



Narrow cut-out

GAS HOBS

Veronika
standard



Veronika

standard

Code	Version	Characteristics	Price
------	---------	-----------------	-------



7067 062  STD cut-out: 560x480

- Satin finish AISI 304
 - Dimensions: **760x500**
 - Cast iron grids and enamelled burner covers
 - Electric ignition
 - Safety valve with ultra-rapid thermocouple
- Total power 10,700 W
 - auxiliary: 1,000 W
 - semirapid: 2x1,750 W
 - rapid: 2,700 W
 - triple crown: 3,500 W



Narrow built-in hole

This model cannot be welded in stainless steel worktops

Accessories: **2** (see page 401)



7066 052  STD cut-out: 560x480

- Satin finish AISI 304
 - Dimensions: **590x500**
 - Cast iron grids and enamelled burner covers
 - Electric ignition
 - Safety valve with ultra-rapid thermocouple
- Total power 7,200 W
 - auxiliary: 1,000 W
 - semirapid: 2x1,750 W
 - rapid: 2,700 W

This model cannot be welded in stainless steel worktops



7063 052  STD cut-out: 420x480

- Satin finish AISI 304
 - Dimensions: **440x500**
 - Cast iron grids and enamelled burner covers
 - Electric ignition
 - Safety valve with ultra-rapid thermocouple
 - Total power 5,850 W
- auxiliary: 1,100 W
 - semirapid: 1,750 W
 - rapid: 3,000 W

Perfect combination with Fortyfour sink **4151 050** (see page 147)



Angolare standard



Accessories: **2** (see page 401)

Code

7038 052

Version

STD

Characteristics

cut-out: see website

Price

- Satin finish AISI 304
- Dimensions: **830x830**
- Cast iron grids and enamelled burner covers
- Electric ignition
- Safety valve with ultra-rapid thermocouple

- Total power 9,750 W
auxiliary: 1,000 W
semirapid: 3x1,750 W
triple crown: 3,500 W



The perfect kitchen corner

Foster Angolare cooker hobs optimise the corner space thanks to the cast iron “pot support” zones that make the cooking grids seamless.

Power
standard

NEW



Code

7016 032

Version

STD

Characteristics

cut-out: 840x480

Price



- Satin finish AISI 304
- Dimensions: **860x500**
- Cast iron grids and enamelled burner covers
- Electric ignition
- Safety valve with ultra-rapid thermocouple

- Total power 11,700 W
- small semirapid: 1,400 W
- semirapid: 2x1,750 W
- rapid: 2,800 W
- double crown: 4,000 W

Model cannot be integrated in stainless steel worktops

NEW

7017 032

STD

cut-out: 840x480



- Satin finish AISI 304
- Dimensions: **860x500**
- Cast iron grids and enamelled burner covers
- Electric ignition
- Safety valve with ultra-rapid thermocouple

- Total power 11,300 W
- auxiliary: 1,000 W
- semirapid: x2 1,750 W
- rapid: 2,800 W
- double crown: 4,000 W

Model cannot be integrated in stainless steel worktops

Power NEW standard

Code	Version	Characteristics	Price
------	---------	-----------------	-------



7015 032  cut-out: 560x480

- Satin finish AISI 304
 - Dimensions: **750x500**
 - Cast iron grids and enamelled burner covers
 - Electric ignition
 - Safety valve with ultra-rapid thermocouple
- Total power 10,900 W
 - auxiliary: 1,000 W
 - semirapid: 1,750 W
 - rapid: 2,800 W
 - small semirapid: 1,400 W
 - double crown: 4,000 W

Model cannot be integrated in stainless steel worktops



Narrow cut-out



NEW **7018 032**  cut-out: 560 x 480

- Satin finish AISI 304
 - Dimensions: **750x500**
 - Cast iron grids and enamelled burner covers
 - Electric ignition
 - Safety valve with ultra-rapid thermocouple
- Total power 10,950 W
 - auxiliary: 1,000 W
 - semirapid: 1,750 W
 - small semirapid: 1,400 W
 - rapid: 2,800 W
 - double crown: 4,000 W

Model cannot be integrated in stainless steel worktops



Narrow cut-out



7014 032  cut-out: 560x480

- Satin finish AISI 304
 - Dimensions: **580x500**
 - Cast iron grids and enamelled burner covers
 - Electric ignition
 - Safety valve with ultra-rapid thermocouple
- Total power 9,550 W
 - auxiliary: 1,000 W
 - semirapid: 1,750 W
 - rapid: 2,800 W
 - double crown: 4,000 W

Model cannot be integrated in stainless steel worktops

GAS HOBS

Power glass

NEW

standard



Code	Version	Characteristics	Price
7044 632	 STD	cut-out: 840x480	



- Black tempered glass
- Dimensions: **900x510**
- Cast iron grids and enamelled burner covers
- Electric ignition
- Safety valve with ultra-rapid thermocouple
- Total power 10,950 W
auxiliary: 1,000 W
semirapid: 1,750 W
small semirapid: 1,400 W
rapid: 2,800 W
double crown: 4,000 W

Power glass NEW

standard

Code	Version	Characteristics	Price
------	---------	-----------------	-------



7042 632  **STD** cut-out: 560x480

- Black tempered glass
 - Dimensions: **700x510**
 - Cast iron grids and enamelled burner covers
 - Electric ignition
 - Safety valve with ultra-rapid thermocouple
- Total power 10,950 W
auxiliary: 1,000 W
semirapid: 1,750 W
small semirapid: 1,400 W
rapid: 2,800 W
double crown: 4,000 W



Narrow cut-out



7043 632  **STD** cut-out: 560x480

- Black tempered glass
 - Dimensions: **700x510**
 - Cast iron grids and enamelled burner covers
 - Electric ignition
 - Safety valve with ultra-rapid thermocouple
- Total power 10,950 W
auxiliary: 1,000 W
semirapid: 1,750 W
small semirapid: 1,400 W
rapid: 2,800 W
double crown: 4,000 W



Narrow cut-out



7041 632  **STD** cut-out: 560x480

- Black tempered glass
 - Dimensions: **600x510**
 - Cast iron grids and enamelled burner covers
 - Electric ignition
 - Safety valve with ultra-rapid thermocouple
- Total power 9,500 W
auxiliary: 1,000 W
semirapid: 1,750 W
rapid: 2800 W
double crown: 4,000 W

Gas hobs

technical drawings

Milanello 5 F

7682 000

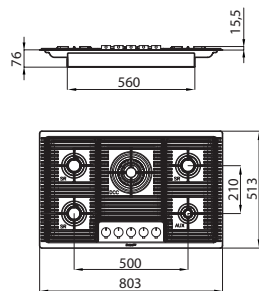

Milanello

7681 000

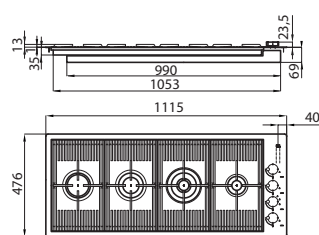

7680 000

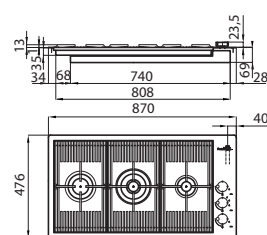

Milano

7639 000

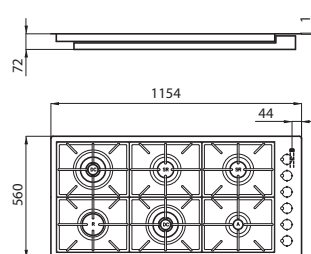

7638 000

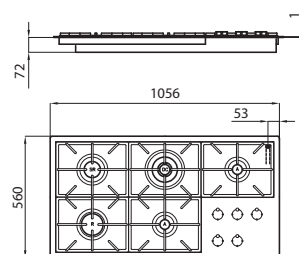

7637 000

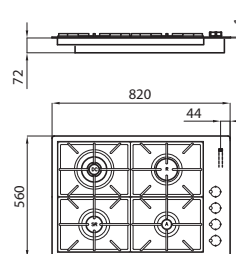

7640 000

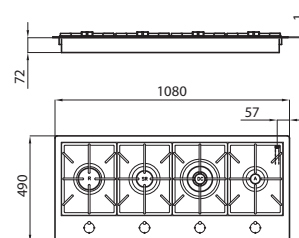

S4000

7257 032

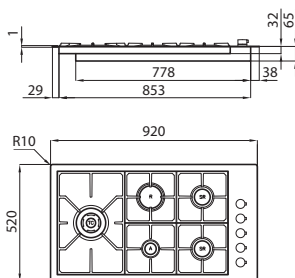

7271 032

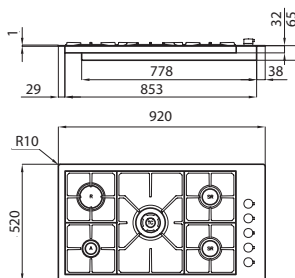

7256 032

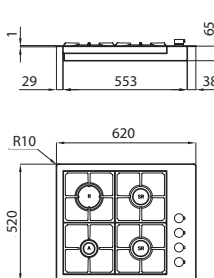

S4000 Domino

7278 032

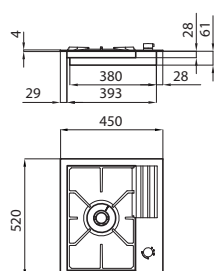

7276 032

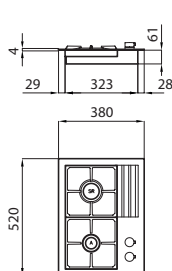

S4000 Line

7284 042

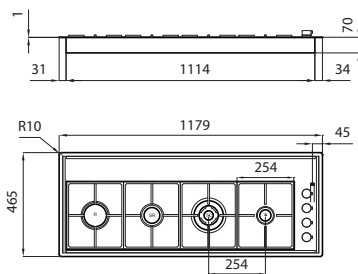

7285 032

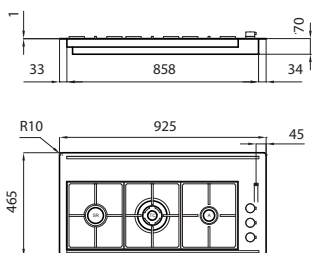

7259 042

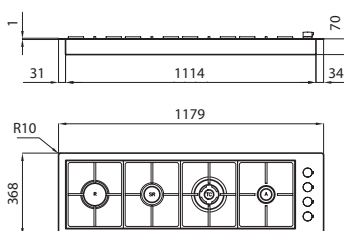

7286 032

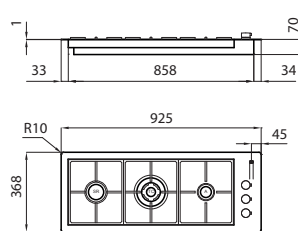

Quadra Angolare | FL

7238 042

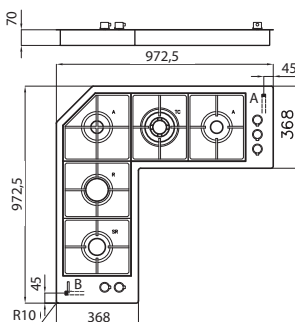

7201 032

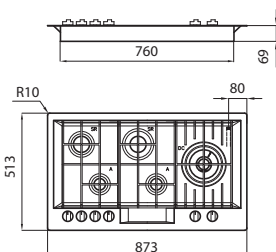

7203 032

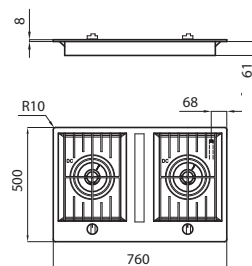

7208 032

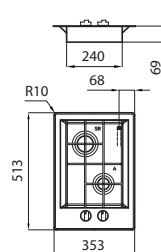

7207 032

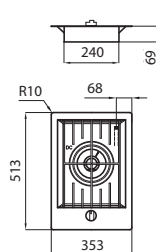

KE

7603 032

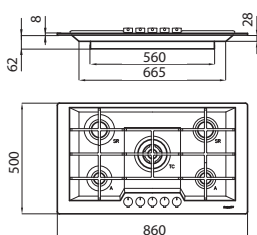

7602 032

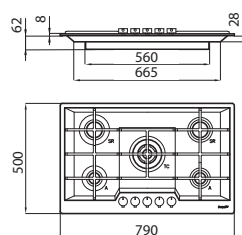

7600 032 - 7601 032

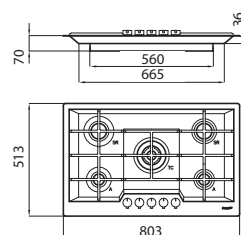

KF NEW

7666 062

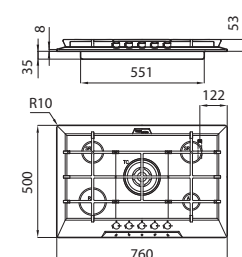

Veronika

7067 062

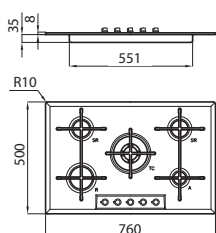

7066 052

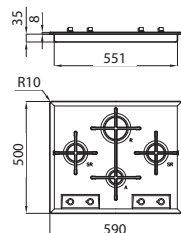

7063 052

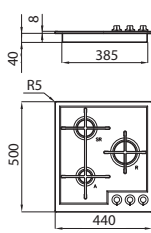

7038 052

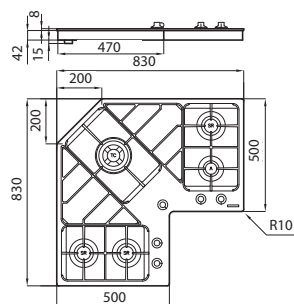

Power

7016 032

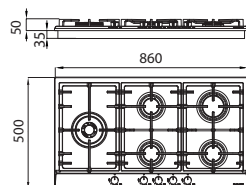

7017 032

NEW

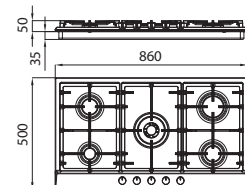

7015 032

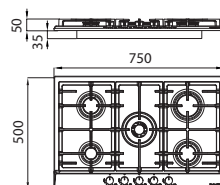

7018 032

NEW

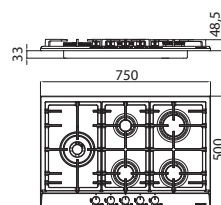

7014 032

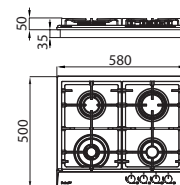

Power Glass

NEW

7044 632

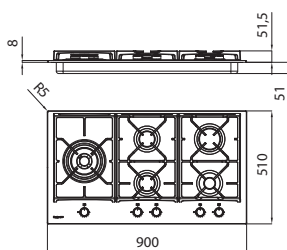

7042 632

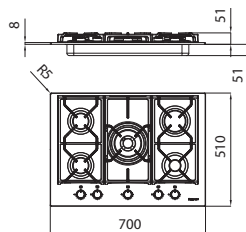

7043 632

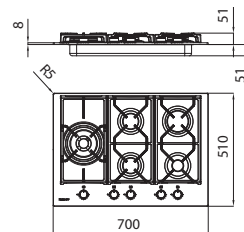

7041 632

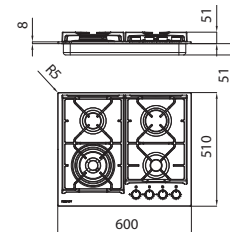

Ovens





Ovens | characteristics



Easy Clean Enamel

The special enamel makes the oven surfaces perfectly non-stick. The limited porosity of the surface ensures easy cleaning.

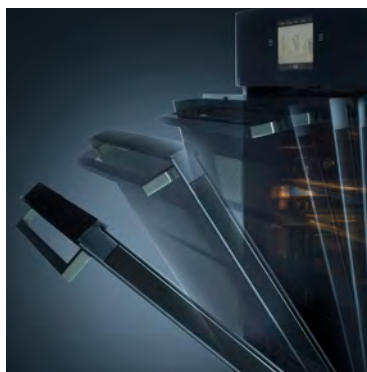

Soft Closing Door

The door's hinges automatically slow down in the final part of their movement, for a gentle and silent closing.



Telescopic guides

Help to distribute space more evenly and make it easier to extract the racks and trays.



Full Glass Door

In many models, the inside of the door is a single smooth glass surface, making it practical for cleaning operations.



Triple glass door

The ovens have a multiple glass door (up to 3 glass panels). This ensures low door temperatures and less heat loss.

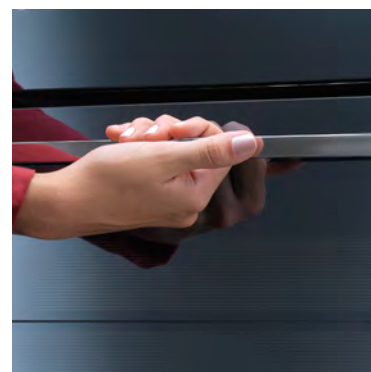

Black Mirror Stop Sol

The special screening and mirroring treatment of the external glass gives the oven an elegant and modern look.



Anti-touch finish

The steel surfaces, thanks to the special protection, are perfectly smooth and protected from fingerprints, and are easy to clean.



Cooking chamber capacity

At the very top of its category for guaranteed capacity. XL indicates that the versions have a capacity of over 60 litres. XXL indicates ovens with even larger, non-standard dimensions.



Heat Probe

It records the temperature at the core of the product at all times. Once the cooking temperature has been set, the oven signals when it is ready and disables the heating elements.



Self-Cooking

Extensive set of recipes and excellent food temperature control. Possibility of adding customised recipes.



Tangential fan

The tangential fan creates a flow of air between the cooking chamber and the framework, thereby reducing the temperature of the surfaces. As a consequence, the oven does not expose furniture to high temperature changes.

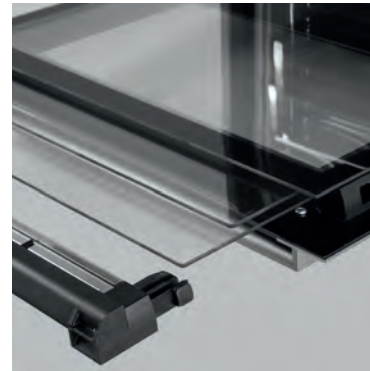

Removable glass

The oven door glass panels can all be removed for cleaning with a simple "click".



Multifunction oven **cooking functions**



Lower-level cooking

Suitable for reheating food.



Upper-level cooking

Suitable for cooking particularly delicate foodstuffs and for keeping them warm after cooking.



Traditional cooking

The ideal function for all traditional recipes, including bread, cakes and roasts.



Fan-assisted cooking

The combination of ventilation and circular heating elements allows you to cook different types of food together, without mixing aromas and flavours.



Intensive cooking

The upper and lower heating elements and the fan ensure rapid, uniform cooking. Ideal for cooking pizzas, roasts, lasagne and savoury pies.



Fan + lower-level cooking

Program with low energy consumption, ideal for heating and for foods that need gentle and progressive cooking.



Rapid pre-heating

This function turns on the heating elements and a flow of hot air rapidly heating the oven to 200°C.



Heat holding

Ideal for keeping your dishes at the correct serving temperature.



Lower-level + fan-assisted cooking

The combined action of static heat from underneath and fan-assisted heat from the circular heating elements for internal cooking of very thick food.



Central grill

Ideal for toasting or cooking small portions au gratin.



Double grill

Heat is generated by the upper grill only: ideal for toasting, cooking au gratin and browning foodstuffs and also suitable for meat, fish and pasta.



Lower-level cooking + grill

To finish off static cooking and brown at the same time.



Fan + grill

Allows rapid and thorough cooking of thick foodstuffs.



Fan + double grill

To finish cooking foods such as roasts and poultry, to perfectly brown your dishes.



Defrosting

Allows you to defrost food in a third of the time through the uniform distribution of air at room temperature.



Pizza function

Lower-level and fan-assisted cooking plus the grill result in a crisp, perfectly cooked pizza.



Eco

Low energy consumption. Uses forced convection heating and interrupts the function a few minutes before the end of cooking, making use of the residual heat.



Lower-level cooking + grill + fan

The uniformity of fan-assisted cooking accompanied by the crispy au gratin finish of the grill.

Gas oven **cooking functions**



Fan-assisted and static gas cooking

The heat of the gas burner can be accompanied by the fan depending on the result to be achieved.



Grill + spit

The combination of grill and spit allow you to brown your dishes to perfection.



Grill

The heat is generated by an electric heating element at the top: ideal for toasting, roasting, cooking au gratin and crisping dishes.

Steam cooking functions

The **S4001 combi steam oven** is a real gem with excellent performance and outstanding versatility. It falls within the class of **gourmet** ovens, featuring the sophisticated technology of professional solutions.

Steam cooking is combined with convection cooking to create a complete set of gourmet cooking programs.

The specialised cooking functions are listed below, in addition to the standard programs of a multifunction oven.



Professional cooking

(steam combi)

Mixed system that combines hot air and steam to produce delicious and succulent dishes, with a professional touch.



Steam only

The benefits of steam for healthy and nutritious cooking. Suitable for all delicate dishes (vegetables, fish, etc.) and for low-temperature cooking (sous vide or jar-cooking).



Regeneration

A specific program to regenerate your dishes which uses steam to restore the correct humidity, combined with hot air between 70° and 130°C.



Oven-Microwave Combi cooking functions

The **S4001 microwave+grill** adds fan-assisted cooking to microwave and grill cooking, with an incredible set of cooking programs.

Extreme convenience for the **KS microwave+grill**, which can be perfectly combined with many steel ovens.

The specialised cooking functions are listed below, in addition to the standard programs of a multifunction oven.



Microwave cooking

Ideal for rapidly cooking or heating vegetables, rice, fish, meat and liquids. They can be set to different operating powers.



Ventilated microwave

The movement of the air generated by the fan ensures more uniform microwave cooking.



Microwave cooking + grill

The ideal combined cooking method for lasagne, potatoes, roasts and pies.



Automatic defrosting

It is possible to defrost by setting the type and weight of the food.



Timed defrosting

It is possible to defrost by setting the process time.





442 | **S4001**

446 | **FL 90** 

448 | **KE** 

452 | **KE 90**

453 | **KS**

S4001



S4001

Multifunction 60 x 60 | 65 litres
Class A++



Code	Finish	Price
------	--------	-------

7131 057	Satin finish anti-touch	
-----------------	----------------------------	--

- 15 cooking functions
- Touch control commands
- Display with intuitive electronic programming
- 3 full extension telescopic guides
- Grill resistance protection
- Safety control block
- Independent oven light
- Programming in 12 languages
- Demo mode
- Supply: 220-240 V 50-60 Hz
- Easy Clean enamel
- Tangential ventilation
- Soft closing door
- Full glass door
- Triple glass door
- Black mirror stop-sol
- Cooking chamber capacity XL
- Heat probe
- Self-cooking

Standard equipment:

- 2 trays with Easy Clean enamel
- 1 stainless steel grid

Functions



Technical drawing on page 454

Steam combi 60 x 46 | 34 litres
Class A++



Code	Finish	Price
------	--------	-------

7135 087	Satin finish anti-touch	
-----------------	----------------------------	--

- Controlled steam injection into cooking chamber
- 8 cooking functions
- Touch control commands
- Puff function
- Oven and steam circuit assisted cleaning cycles
- Stainless steel cooking chamber
- Independent oven light
- Programming in 12 languages
- Demo mode
- Supply: 220-240 V 50 Hz
- Easy Clean enamel
- Soft closing door
- Triple glass door
- Black mirror stop-sol
- Heat probe
- Self-cooking
- Tangential ventilation

Standard equipment:

- 1 2/3 Gastronorm tray H20
- 1 deep 2/3 Gastronorm tray H40 with lid and stainless steel support grid
- 1 stainless steel grid

Functions



Technical drawing on page 454

S4001

Combi-microwave 60 x 46 | 34 litres

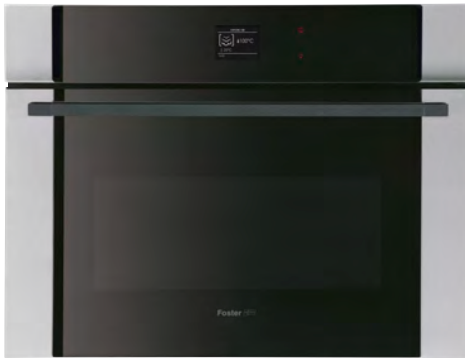

Code	Finish	Price
7136 027	Satin finish anti-touch	

- 9 cooking functions
- Microwave power 1000 W
- Touch control commands
- Editable programmed recipes
- Defrost function by time and weight
- Stainless steel cooking chamber
- Independent oven light
- Supply: 220-240 V 50 Hz
- Black mirror stop-sol
- Self-cooking
- Tangential ventilation

Standard equipment:

- 1 Integrated rotating plate Ø 32 cm
- 1 stainless steel round grid
- 1 stainless steel 2/3 Gastronorm tray H20
- 1 stainless steel grid

Functions



Technical drawing on page 454

Plate-warmer module 60 x 14



Code	Finish	Price
7138 001	Satin finish anti-touch	

- Module 60x14 cm
- Extractable trolley
- Stainless steel interior and crystal cabinet
- Temperature: 40 - 70°C
- Suitable for heating and maintaining food temperature
- Black mirror stop-sol
- Supply: 220-240 V 50 Hz



Technical drawing on page 454



Perfect alignment

The 60 cm high multifunction oven and 46 cm high specialised ovens have a perfect alignment of the handle and dashboards, thus lending themselves to any type of vertical or horizontal combination.

FL90



FL90

Multifunction 90 x 48 | 91 litres
Energy class A

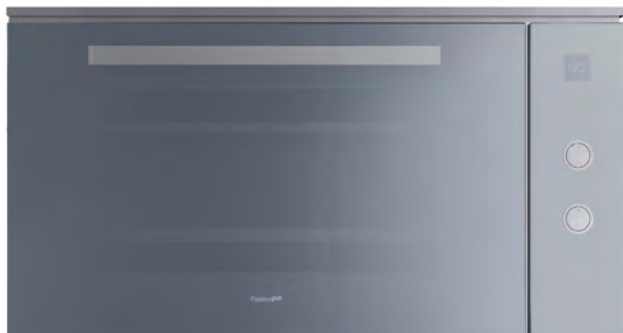

7107 640 Inox



NEW

7107 646 Gun Metal



NEW

Code	Finish	Price
------	--------	-------

7107 642	Black mirror	
-----------------	--------------	--

- 10 cooking functions
- Display with electronic start-end cooking program and push-pull controls
- Maxi-Grill (collapsible)
- Grill resistance protection
- Halogen lighting on both walls, switches on when the door is opened
- Door contact switch
- Supply: 220-240V 50-60Hz
- Removable glass
- Easy Clean enamel
- 2 telescopic guides
- Full glass door
- Triple glass door
- Black mirror stop-sol
- Cooking chamber capacity XXL
- Tangential ventilation

Standard equipment:

- deep tray
- stainless steel grill

Functions



Technical drawing on page 454

KE



Multifunction 75 x 60 | 89 litres
Energy class A



Code

Finish

Price

7137 000Satin finish
anti-touch

- 9 cooking functions
- Electronic start-end cooking programming
- 1 telescopic guide
- Supply: 220-240 V 50-60 Hz
- Easy Clean enamel
- Soft closing door
- XL chamber capacity
- Tangential ventilation
- Removable glass
- Triple glass door
- Full Glass door

Standard equipment:

- 2 trays with Easy Clean enamel
- 1 stainless steel grid

Functions



Technical drawing on page 454

KE



Multifunction 60 x 60 | 70 litres
Energy class A



Code	Finish	Price
------	--------	-------

7142 045	Satin finish anti-touch	
-----------------	----------------------------	--

- 10 cooking functions
- Electronic start-end cooking programming
- 3 telescopic guides
- Removable door glass
- Grill resistance protection
- Supply: 220-240 V 50-60 Hz
- Easy Clean enamel
- Soft closing door
- Full glass door
- Triple glass door
- Cooking chamber capacity XL
- Tangential ventilation
- Removable glass

Standard equipment:

- 1 tray and 1 dripping pan with Easy Clean XXL enamel
- 1 stainless steel grid

Functions



Technical drawing on page 454

Multifunction 60 x 60 | 70 litres
Energy class A



Code	Finish	Price
------	--------	-------

7141 044	Satin finish anti-touch	
-----------------	----------------------------	--

- 8 cooking functions
- Electronic start-end cooking programming
- 1 telescopic guide
- Removable door glass
- Grill resistance protection
- Supply: 220-240 V 50-60 Hz
- Easy Clean enamel
- Soft closing door
- Full glass door
- Triple glass door
- Cooking chamber capacity XL
- Tangential ventilation
- Removable glass

Standard equipment:

- 1 tray and 1 dripping pan with Easy Clean XXL enamel
- 1 stainless steel grid

Functions



Technical drawing on page 454

KE90

Multifunction 90 x 60 | 103 litres
Energy class A



Code

Finish

Price

7126 047

Satin finish
anti-touch

- 9 cooking functions
- Electronic start-end cooking programming
- Digital display
- Grill resistance protection
- Independent oven light
- Supply: 220-240 V 50-60 Hz
- Easy Clean enamel
- Full glass door
- Triple glass door
- Cooking chamber capacity XXL
- Tangential ventilation

Standard equipment:

- 2 grids
- 1 enamelled dripping pan

Functions



Technical drawing on page 455

Ventilated gas oven 90x60 | 91 litres
Energy class A



Code

Finish

Price

7193 047

Satin finish
anti-touch

- 4 cooking functions
- Electronic grill
- Ignition under knob
- Safety valve
- End of cooking timer
- Independent oven light
- Supply: 220-240 V 50-60 Hz
- Easy Clean enamel
- Full glass door
- Triple glass door
- Cooking chamber capacity XXL
- Tangential ventilation

Standard equipment:

- 1 dripping pan
- 1 grid
- 1 spit

Notes: The oven is tested and supplied with LPG nozzles; nozzles for natural gas are also supplied as spares with the oven

Functions



Technical drawing on page 455

Multifunction PP 60 x 60 | 70 litres
Energy class A



Code	Finish	Price
------	--------	-------

7122 055 Satin finish
anti-touch

- 8 cooking functions
- End of cooking timer
- 2 door glass panels
- Removable door glass
- Grill resistance protection
- Supply: 220-240 V 50-60 Hz
- Easy Clean enamel
- Full glass door
- Cooking chamber capacity XL
- Tangential ventilation

Standard equipment:

- 1 tray and 1 dripping pan with Easy Clean XXL enamel
- 1 stainless steel grid

Functions



Technical drawing on page 455

Microwave+grill 60 x 38 | 25 litres



Code	Finish	Price
------	--------	-------

7151 010 Satin finish
anti-touch

- 5 cooking functions
- 8 Self-Cooking programs
- 5 power levels up to 900 W (1000 W Grill)
- Electronic programming
- Automatic defrosting by time and weight
- Stainless steel cooking chamber
- Supply: 230 V / 50 Hz

Standard equipment:

- 1 grill
- 1 turntable

Functions



Technical drawing on page 455

S4001

7131 054

7135 081

7136 021

7138 001

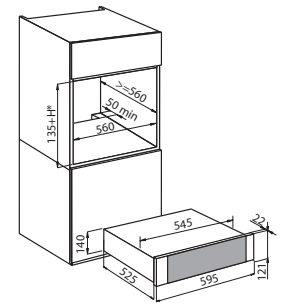
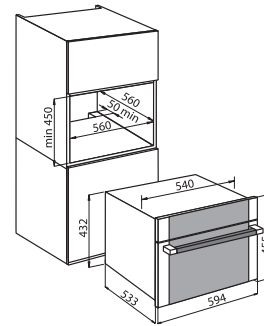
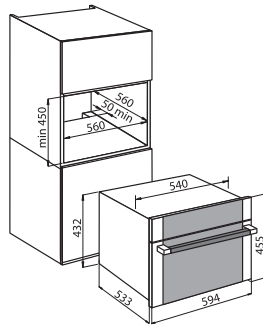
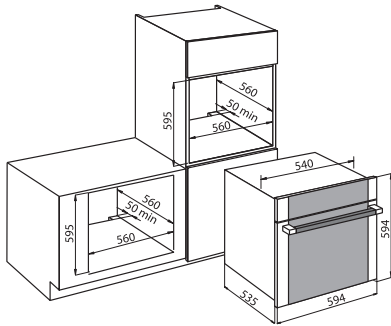

FL90

7107 642

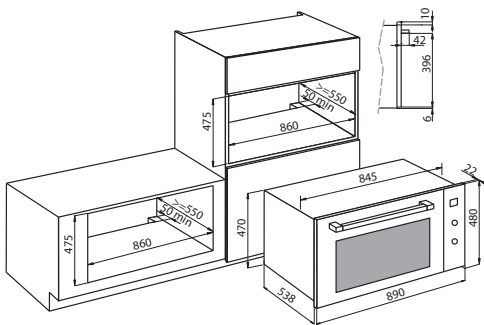

KE

7137 000



7142 045

7141 044

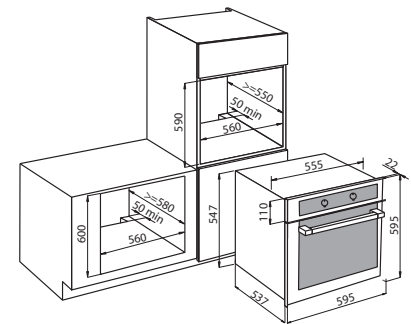
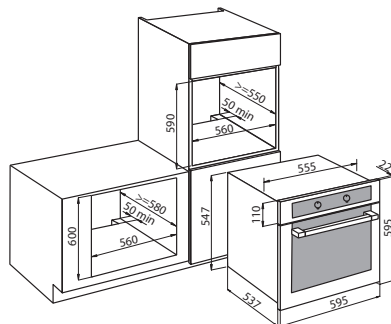
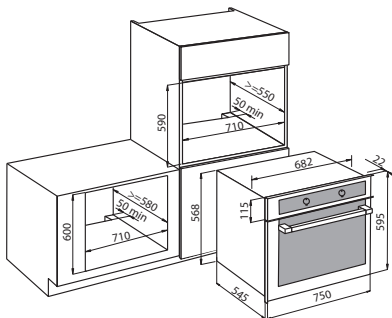

KE90

7126 047

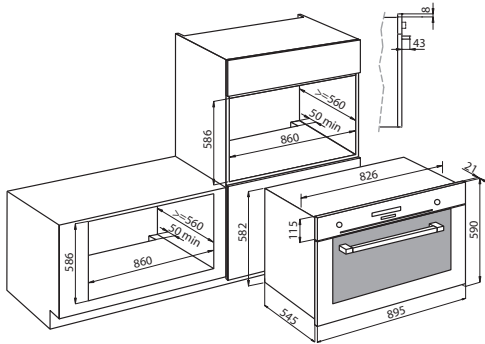

7193 047

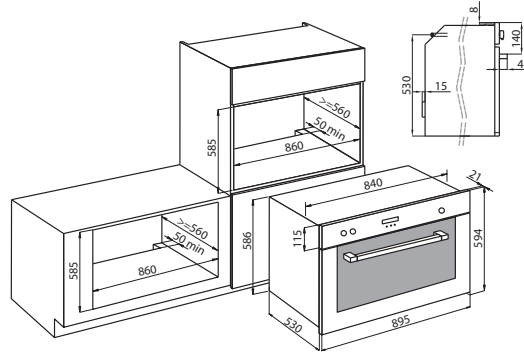

7122 055

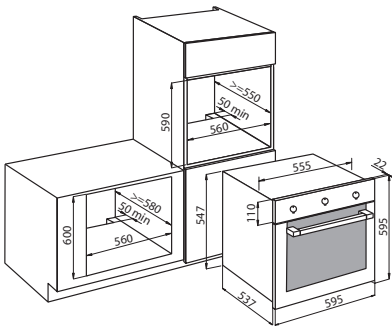

7151 010

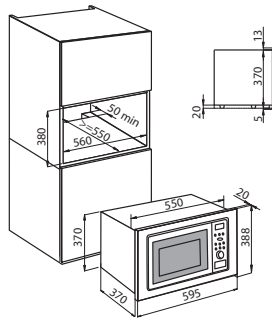

Hoods





Every kitchen has its own **hood**



Wall-mounted hoods

A vast choice of solutions differing in sizes, shapes, materials and functionality.



Ceiling-mounted suction systems

Not just simple hoods, but complete air circulation systems to improve air quality and comfort.



Built-in hoods

They disappear into the kitchen wall units without losing their visual appeal and functionality.



Island hoods

Island versions are available for many models for versatile installation thanks to telescopic flues.



Worktop hoods

Elegant and minimal, they combine with in-line hobs and domino solutions, both gas and induction.



Custom hoods

Projects to customer specifications, matching seamlessly with the design, and steel finish of the worktop



Characteristics



Timed switch-off

Delayed switch-off can be set, so as to prolong air circulation around the room even after use.



Filter cleaning notification

It monitors the operating hours and indicates when the filter needs cleaning for optimal efficiency.



Brushless motor

Allows high air flow rates while maintaining a low energy consumption. Furthermore, it has an almost never-ending duration.



Minimum footprint

Ceiling systems that require little space. Less than 20 cm is required between the ceiling and the false ceiling.



Remote motor

The remote motor can be installed with the Remote Motor Kit.



LED light points

Elegant, designer lighting with individual light points.



Remote control

The hood functions can be controlled with the remote control from the comfort of any position.



Perimeter suction

The filters are hidden by plates and the suction occurs through the perimeter slots. Aesthetics are more streamlined, cleaning is easier, the suction power and noise-level are improved.



Hood distance 50 cm

The hood can be fitted only 50 cm from the work-top, a much smaller distance than standard, with great suction efficiency.



AISI 304 stainless steel

Pitagora, Cilindro, S4001 and Ghost are made of AISI 304 stainless steel, for a perfect combination with hobs.



Tips on how to choose

Sizing and installation are important to optimise efficiency, performance, consumption and noise level. Here are some practical tips to make your choice easier.

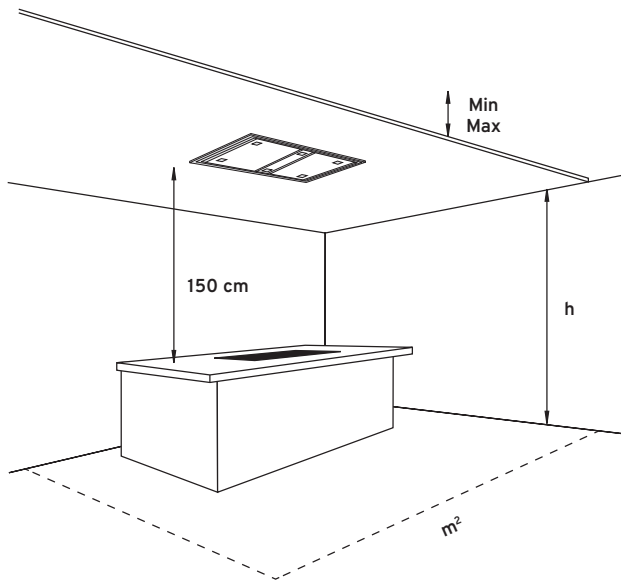

Flow rate sizing

The suction capacity is proportional to the volume of the room to ensure adequate air circulation. The flow rate is calculated by multiplying the volume of the room by 12 (number of air changes per hour). For ceiling systems, consider an air change of 15 cycles/hour.

$$\begin{matrix} m^2 \\ \text{Kitchen area} \end{matrix} \times \begin{matrix} h \\ \text{Kitchen height} \end{matrix} \times \begin{matrix} 12 \\ \text{no. of air changes per hour} \end{matrix} = \begin{matrix} m^3/h \\ \text{Flow rate (suction capacity required)} \end{matrix}$$

Installation over the hob

The perfect height over the hob is 65 cm. For wall-mounted hoods with oblique suction surface, the height over the median of the suction filter is taken into account.

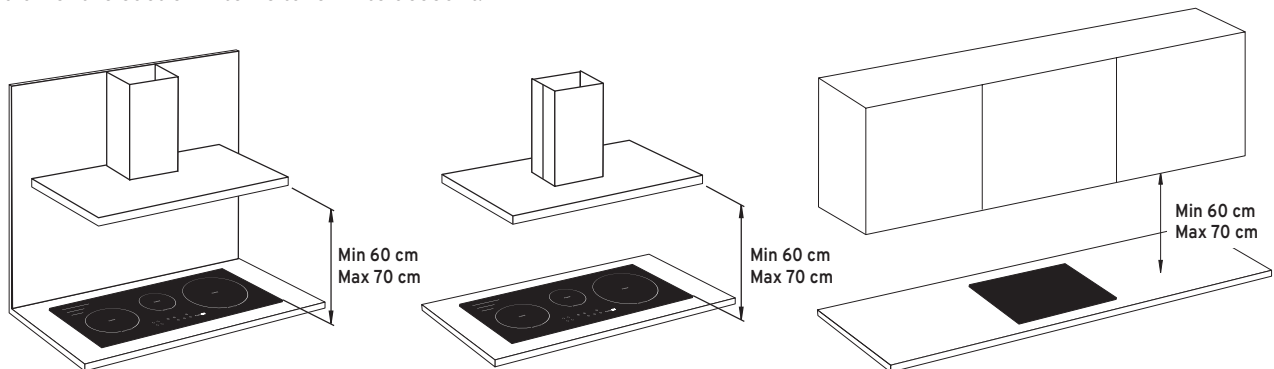

For ceiling systems, we recommend keeping the ceiling height at no higher than 150 cm from the hob.

Hood width

The size must be adequate for that of the hob. A slight oversizing allows optimal suction.

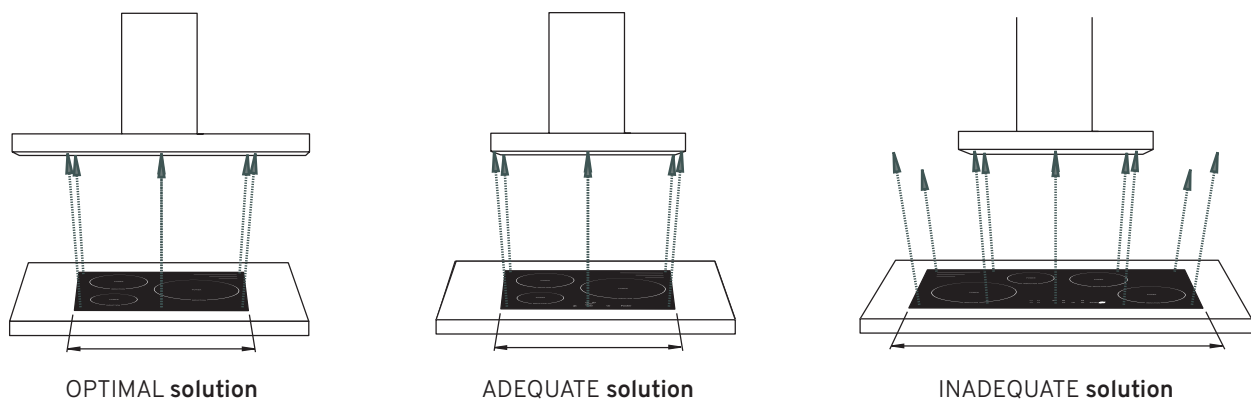

Installation of pipes

Air pipes should be as straight as possible. A winding route will result in a loss of flow rate and consequent low suction. Do not duct air into pipes used for fume exhaust.

Draughts

For smooth operation, the hood should be installed away from draughts.

Air ducts

Fume exhaust ducts must have an internal diameter not lower than 120 mm.

Ducting systems for hoods and suction hobs

Space-saving ducting system with rectangular section



9700 532
white tube
with rectangular section 222x89 mm
dim: 222x89x1000 mm



9700 537
rect. / round adapter
sect. 227x94 mm / \varnothing 158 mm
dim: 190x 150x227 mm



9700 533
white connector
with rectangular section 227x94 mm
dim: 227x94x80 mm



9700 538
no-return valve \varnothing 148 mm



9700 534
horizontal 90° corner connector
with rectangular section: 227x94 mm
dim: 288x288x94 mm



9700 539 *
grey grid for plinth
for plinths 100/150 mm
dim: 273x150 mm



9700 535
vertical 90° corner connector
with rectangular section: 227x94 mm
dim: 174x174x227 mm

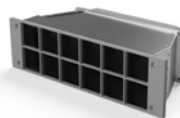

9700 574 *
carbon filter for plinth
100-150 mm



9700 536
horizontal 15° corner connector
with rectangular section: 227x94 mm
dim: 233x138x94 mm

9700 575 *
active carbon refill for filter
plinth

* only for Ghost hoods and suction hobs.



464 **S4001 Special**

466 **S4001**

467 **Cilindro**

468 **Pitagora**

469 **Peraria** **NEW**

471 **Ghost**

473 **Amélie**

474 **KS** **NEW**

475 **New Wing** **NEW**

S4001 Special island



S4001 Special Island



Length	No. LED light points	Energy class
1201 - 1500	9	A+
1501 - 2100	12	A+
2101 - 3000	15	A

Code	Size mm	Finish	Price
2442 150	1201 - 1500	Satin finish	
2442 210	1501 - 2100	Satin finish	
2442 300	2101 - 3000	Satin finish	

- High Performance Brushless motor
- Minimal electronic controls
- 2 grease filters
- 4 operating speeds
- LED lighting (1W . 5,600 kelvin)
- Perimeter suction
- Automatic delayed switch-off
- Optional filtering mode
- Telescopic rods in Ø28 / 25 mm tube
- 4 suction flaps (120 cm) in the centre
- Central chimney
- Chimney height: 810 - 1220 mm
- Air exhaust hole: Ø 120/150 mm

Max.m³/h: 568
 Int.m³/h: 672
 Pressure (Pa): 464
 Max.noise level (dba): 64
 Int.noise level (dba): 68
 Power (W): 165

Options on request with surcharge:

- Ladle rod
- Large steel shelf (min.thickness 30 mm)
- Rods with steel cable ø 3 mm*
- Vintage steel finish
- Off-centre chimney
- Shaped chimney for sloping ceiling
- Out-of-square Hood side
- Fixed tubular rods ø 10 mm
- Deeper hood body
- Retractable stainless steel brackets for support

Accessories:

Long Life carbon filter kit **9700 001**



Technical drawing on page 476

S4001 Special wall

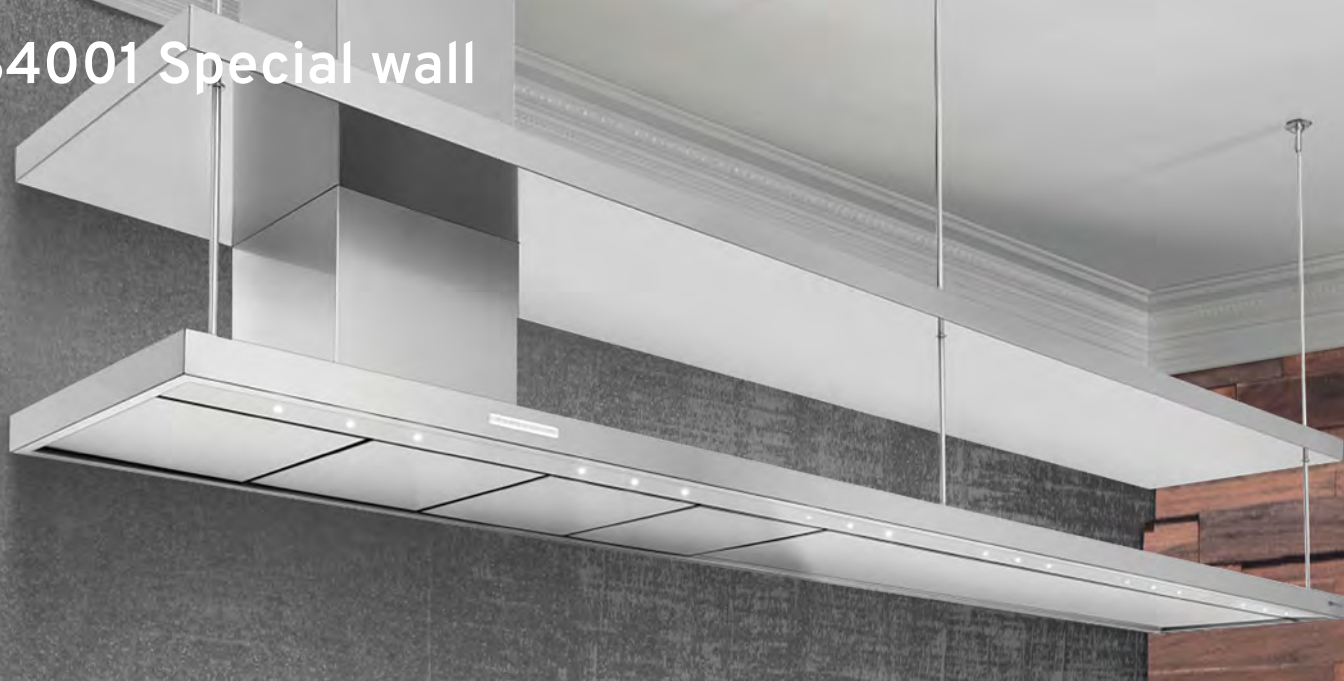

S4001 Special Wall

Length	No. LED light points	Energy class
1201 - 1500	9	A+
1501 - 2100	12	A+
2101 - 3000	15	A

Options on request with surcharge:

- Ladle rod
- Large steel shelf (min.thickness 30 mm)
- Rods with steel cable \varnothing 3 mm*
- Vintage steel finish
- Off-centre chimney
- Shaped chimney for sloping ceiling
- Out-of-square Hood side
- Fixed tubular rods \varnothing 10 mm
- Deeper hood body
- Retractable stainless steel brackets for support



Technical drawing on page 476

Code	Size mm	Finish	Price
2440 150	1201 - 1500	Satin finish	
2440 210	1501 - 2100	Satin finish	
2440 300	2101 - 3000	Satin finish	

- High Performance Brushless motor
- Minimal electronic controls
- 2 grease filters
- 4 operating speeds
- LED lighting (1W . 5,600 kelvin)
- Perimeter suction
- Automatic delayed switch-off
- Optional filtering mode
- Telescopic rods in \varnothing 28 / 25 mm tube

- 4 suction flaps (120 cm) in the centre
- Central chimney
- Chimney height 630 - 1050 mm
- Air exhaust hole: \varnothing 120/150 mm

Max.m³/h: 568
 Int.m³/h: 672
 Pressure (Pa): 464
 Max.noise level (dba): 64
 Int.noise level (dba): 68
 Power (W): 165

Accessories:

Long Life carbon filter kit

9700 001

Type of rods



Optional fixing with steel cables \varnothing 3 mm.



Standard fixing with telescopic rods in tube \varnothing 28/25 mm



Optional fixing with tubular rods \varnothing 10 mm



S4001 wall-mounted hood with large stainless steel shelf and off-centre chimney.

Finishes

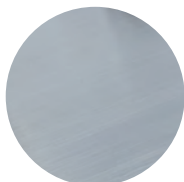

Satin Finish

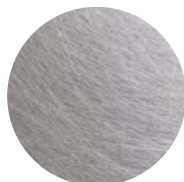

Vintage Finish

S4001



■ S4001 Island



Code	Finish	Price
2442 091 90 cm	Satin finish	
2442 121 120 cm	Satin finish	

- Island extractor hood with telescopic chimney
- High Performance Brushless motor
- Minimal electronic controls
- 2 grease filters
- 4 operating speeds
- LED lighting 6 x 1W (5,600 kelvin)
- Perimeter suction
- Automatic delayed switch-off
- Optional filtering mode
- Chimney height: 630 - 1050 mm
- Air exhaust hole: Ø 120/150 mm
- Energy class: A+
- Max.m³/h: 568
- Int.m³/h: 672
- Pressure (Pa): 464
- Max.noise level (dba): 64
- Int.noise level (dba): 68
- Power (W): 165

Accessories:
Long Life carbon filter kit **9700 001**



Technical drawing on page 476

■ S4001 Wall



Code	Finish	Price
2440 091 90 cm	Satin finish	
2440 121 120 cm	Satin finish	

- Wall-mounted extractor hood with telescopic chimney
- High Performance Brushless motor
- Minimal electronic controls
- 2 grease filters
- 4 operating speeds
- LED lighting 6 x 1W (5,600 kelvin)
- Perimeter suction
- Automatic delayed switch-off
- Optional filtering mode
- Chimney height: 810 - 1220 mm
- Air exhaust hole: Ø 120/150 mm
- Energy class: A+
- Max.m³/h: 568
- Int.m³/h: 672
- Pressure (Pa): 464
- Max.noise level (dba): 64
- Int.noise level (dba): 68
- Power (W): 165

Accessories:
Long Life carbon filter kit **9700 001**



Technical drawing on page 476

Cilindro



Cilindro Wall



Code

Finish

Price

2531 001

Satin finish

Ø 38 cm

Wall-mounted extractor hood

- Minimal electronic controls
- 1 stainless steel grease filter
- 4 operating speeds
- LED lighting 4 x 1.2W (5,500 kelvin)
- Automatic delayed switch-off
- Brushless motor

Height: 920 mm

Air exhaust hole: Ø 120/150 mm

Optional filtering mode

Energy class: A+

Max.m³/h: 550

Int.m³/h: 652

Pressure (Pa): 462

Max.noise level (dbA): 63

Int.noise level (dbA): 67

Power (W): 165

Accessories:

Carbon filter

9700 380



Technical drawing on page 476

Cilindro Island



Code

Finish

Price

2530 001

Satin finish

Ø 38 cm

Island telescopic extractor hood

- Minimal electronic controls
- 1 stainless steel grease filter
- 4 operating speeds
- LED lighting 4 x 1.2W (5,500 kelvin)
- Automatic delayed switch-off
- Brushless motor

Height: 920 - 1330 mm

Air exhaust hole: Ø 120/150 mm

Optional filtering mode

Energy class: A+

Max.m³/h: 550

Int.m³/h: 652

Pressure (Pa): 462

Max.noise level (dbA): 63

Int.noise level (dbA): 67

Power (W): 165

Accessories:

Carbon filter

9700 380



Technical drawing on page 476

Pitagora



Pitagora



Code

Finish

Price

2439 003

Satin finish

90x90 cm

Corner extractor hood
with telescopic chimney

- Minimal electronic controls
- 2 anodised aluminium grease filters
- 4 operating speeds
- LED lighting 2 x 1.2W (4,000 kelvin)
- Automatic delayed switch-off

Accessories:

Carbon filter **9700 409**

Chimney height:

450 - 850 mm

Air exhaust hole:

Ø 150 mm

Optional filtering
mode

Energy class: A

Max.m³/h: 557

Int.m³/h: 751

Pressure (Pa): 473

Max.noise level (dbA): 64

Int.noise level (dbA): 70

Power (W): 290



AISI
304

Technical drawing on page 476



Peraria Stainless Steel



Code	Finish	Price
------	--------	-------

2522 101 100 cm	Satin finish	
---------------------------	--------------	--

Ceiling-mounted extractor hood • Remote control • 2 grease filters • 4 operating speeds • Perimeter suction • Brushless motor Air exhaust hole: 222 x 90 mm Ceiling-false ceiling distance: min 184 mm / max 250 mm Built-in hole: 476 x 976 Optional filtering mode	Energy class: A++ Max.m ³ /h: 584 Int.m ³ /h: 725 Pressure (Pa): 477 Max.noise level (dbA): 65 Int.noise level (dbA): 70 Power (W): 165
--	---

Accessories:
Carbon filter **9700 592**



Technical drawing on page 476

Peraria White

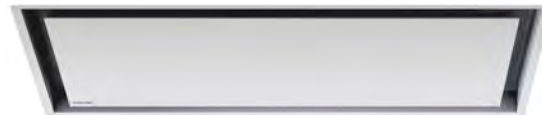

Code	Finish	Price
------	--------	-------

2522 111 100 cm	White	
---------------------------	-------	--

Ceiling-mounted extractor hood • Remote control • 2 grease filters • 4 operating speeds • Perimeter suction • Brushless motor Air exhaust hole: 222 x 90 mm Ceiling-false ceiling distance: min 184 mm / max 250 mm Built-in hole: 476 x 976 Optional filtering mode	Energy class: A++ Max.m ³ /h: 584 Int.m ³ /h: 725 Pressure (Pa): 477 Max.noise level (dbA): 65 Int.noise level (dbA): 70 Power (W): 165
--	---

Accessories:
Carbon filter **9700 592**



Technical drawing on page 476



Ghost



Ghost 90



FT SPT

Code | Finish | Price

2451 090 | Satin finish
90 cm | Black glass

Table-top extractor hood

- Remote control
- 2 anodised aluminium grease filters
- 4 operating speeds
- LED Strip lighting (5W . 4,200 kelvin)
- Filter cleaning notice
- Automatic delayed switch-off

Height from surface: 300 mm

Dimensions on surface:

875 x 120 mm

Built-in hole:

- top-mount installation:

842 x 100 mm

- flush-mount installation:

see technical drawing

Air exhaust hole: Ø 120/150 mm

Energy class: A

Max.m³/h: 503

Int.m³/h: 757

Pressure (Pa): 477

Max.noise level (dbA): 61

Int.noise level (dbA): 68

Power (W): 280

Accessories:

Carbon filter **9700 497**

Remote motor kit **9700 459**

Note: The motor can be positioned frontally, on the back of the hood and in remote mode with the appropriate optional kit.



Technical drawing on page 477

Ghost 120



FT SPT

Code | Finish | Price

2451 120 | Satin finish
120 cm | Black glass

Table-top extractor hood

- Remote control
- 2 anodised aluminium grease filters
- 4 operating speeds
- LED Strip lighting (5W . 4,200 kelvin)
- Filter cleaning notice
- Automatic delayed switch-off

Height from surface: 300 mm

Dimensions on surface: 1175 x

120 mm

Built-in hole:

- top-mount installation:

1142 x 100 mm

- flush-mount installation:

see technical drawing

Air exhaust hole: Ø 120/150 mm

Energy class: A

Max.m³/h: 500

Int.m³/h: 791

Pressure (Pa): 480

Max.noise level (dbA): 58

Int.noise level (dbA): 65

Power (W): 284

Accessories:

Carbon filter **9700 460**

Remote motor kit **9700 459**

Note: The motor can be positioned frontally, on the back of the hood and in remote mode with the appropriate optional kit.

Installation drawing with remote motor kit

The red parts in the drawing are a kit for installing the motor remotely, at up to 5 metres away.

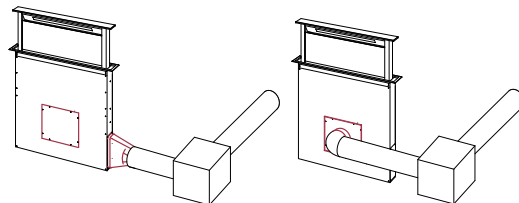

S4000 Domino Ghost



Domino Ghost

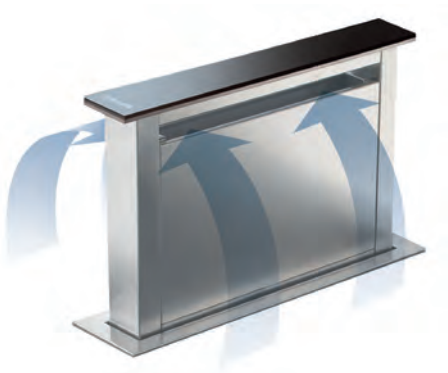

Ghost hoods offer great installation versatility. The motor can be positioned frontally, on the back of the hood and in remote mode with the appropriate optional kit (see technical drawing).

Installation drawing with remote motor kit

The red parts in the drawing are a kit for installing the motor remotely, at up to 5 metres away.

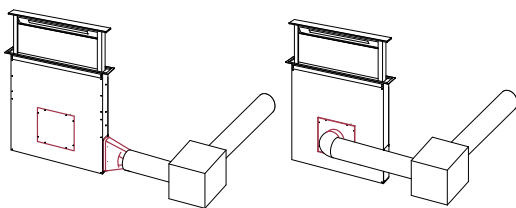

Code

2451 000
52 cm

Finish

Satin finish
Black glass

Price

- Table-top extractor hood
- Electronic Touch controls
 - 1 grease filter
 - 4 operating speeds
 - Suction on two sides
 - Filter cleaning notice
 - Automatic delayed switch-off

Height from surface:
adjustable 180 - 300 mm
Dimensions on surface: 520 x 120 mm
Built-in hole: 490 x 104 mm
Air exhaust hole: Ø 120/150 mm

Energy class: B
Max.m³/h: 636
Int.m³/h: 636
Pressure (Pa): 446
Max.noise level (dB): 69
Int.noise level (dB): 69
Power (W): 275

Accessories:

2 carbon filters kit **9700 450**
Remote motor installation kit **9700 459**



Technical drawing on page 477

Amélie



Amélie



Code

Finish

Price

2447 090

Satin finish

90 cm

Wall-mounted extractor hood with telescopic chimney

- Electronic soft touch controls
- 3 grease filters
- 3 operating speeds
- LED lighting 2 x 1.2W (4,000 kelvin)

Chimney height:

- in suction mode:

580 - 1000 mm

- in filtering mode:

50 - 1070 mm

Air exhaust hole: Ø 120/150 mm

Optional filtering mode

Energy class: A

Max.m³/h: 480

Int.m³/h: 618

Pressure (Pa): 402

Max.noise level (dbA): 64

Int.noise level (dbA): 67

Power (W): 224

Accessories:

Carbon filters kit **9700 517**

Technical drawing on page 477

KS

NEW



KS inox



Code	Finish	Price
------	--------	-------

2504 194 90 cm	Satin finish	
-----------------------	--------------	--

Wall-mounted extractor hood with telescopic chimney

- Electronic controls
- 3 grease filters
- 4 operating speeds
- LED lighting 2 x 1.2W (4,000 kelvin)

Chimney height:
 - in suction mode: 580 - 1000 mm
 - in filtering mode: 650 - 1070 mm
 Air exhaust hole:
 Ø 120/150 mm

Accessories:

Carbon filter **9700 517**

Energy class: A
 Max.m³/h: 632
 Pressure (Pa): 384
 Max.noise level (dba): 66
 Power (W): 224

KS black



Code	Finish	Price
------	--------	-------

2504 394 90 cm	Black	
-----------------------	-------	--

Wall-mounted extractor hood with telescopic chimney

- Electronic controls
- 3 grease filters
- 4 operating speeds
- LED lighting 2 x 1.2W (4,000 kelvin)

Chimney height:
 - in suction mode: 580 - 1000 mm
 - in filtering mode: 650 - 1070 mm
 Air exhaust hole:
 Ø 120/150 mm

Accessories:

Carbon filter **9700 517**

Energy class: A
 Max.m³/h: 632
 Pressure (Pa): 384
 Max.noise level (dba): 66
 Power (W): 224

Technical drawing on page 477

New Wing NEW



The only hood that can be installed only 50 cm from the hob

■ New Wing



Code	Finish	Price
------	--------	-------

2512 062 60 cm	Satin finish/glass	
NEW 2512 072 75 cm	Satin finish/glass	
2512 092 90 cm	Satin finish/glass	
NEW 2512 122 120 cm	Satin finish/glass	

- Built-in undercabinet extractor hood
- Smart rotary control
 - Aluminium grease filters
 - 4 operating speeds
 - LED lighting 2 x 1.2W (4,000 kelvin)
 - Stainless steel cabinet protection profiles
 - Telescopic depth regulator
 - Cabinet back panel stop

Minimum height from surface: only 50 cm
 Air exhaust hole: Ø 150 mm
 Optional filtering mode

Energy class: A
 Max.m³/h: 650
 Pressure (Pa): 444
 Max.noise level (dbA): 69
 Power (W): 230

Accessories:
 Carbon filters kit **9700 221**



Technical drawing on page 477

S4001 Special island

2442 150
2442 210
2442 300

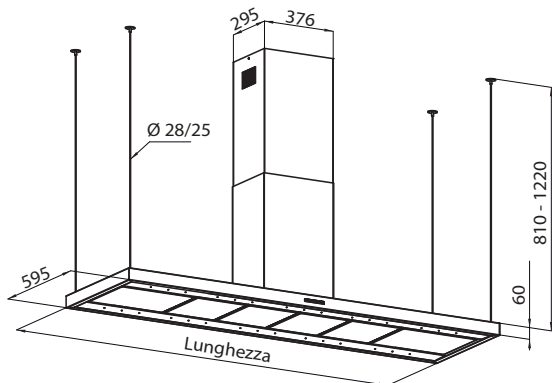

S4001 Special wall

2440 150
2440 210
2440 300

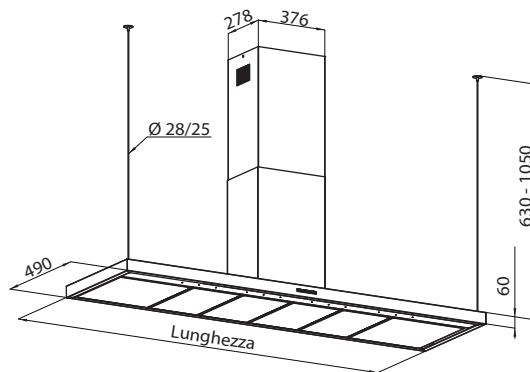

S4001 island

2442 091 90 cm
2442 121 120 cm

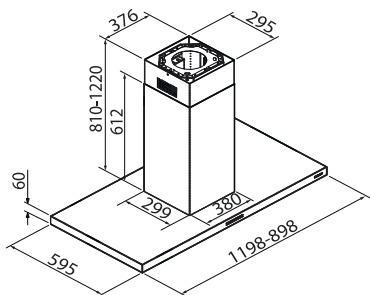

S4001 wall

2440 091 90 cm
2440 121 120 cm

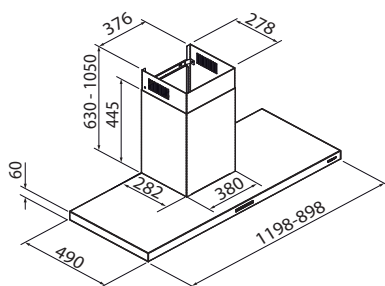

Cilindro Wall

2531 001

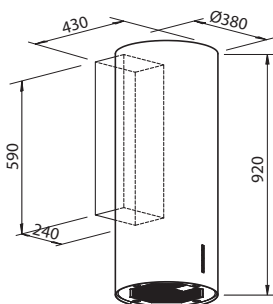

Cilindro Island

2530 001

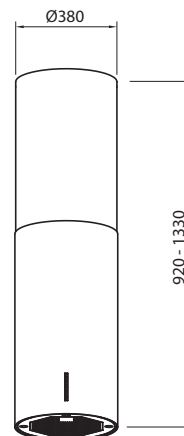

Pitagora

2439 003

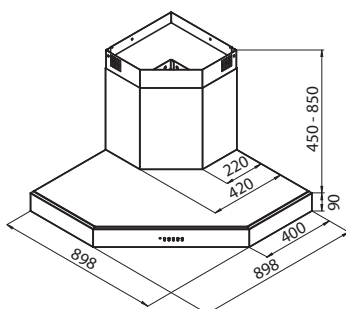

Peraria **NEW**

2522 101
2522 111

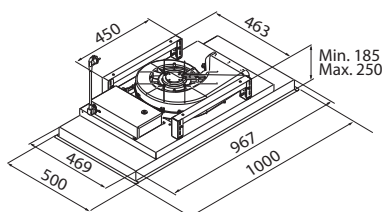

Ghost

2451 090 90 cm

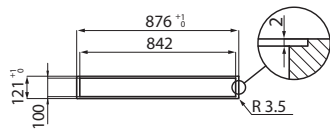
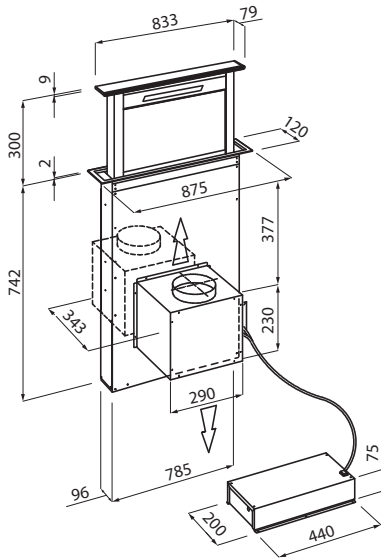

Hole for flush-mount installation

2451 120 120 cm

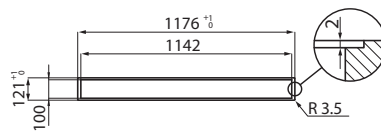
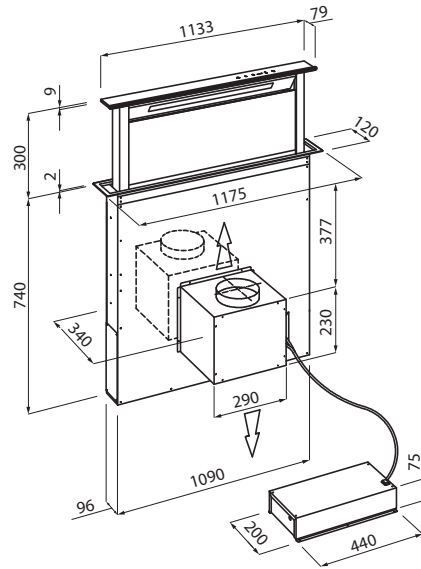

Hole for flush-mount installation

Domino Ghost

2451 000

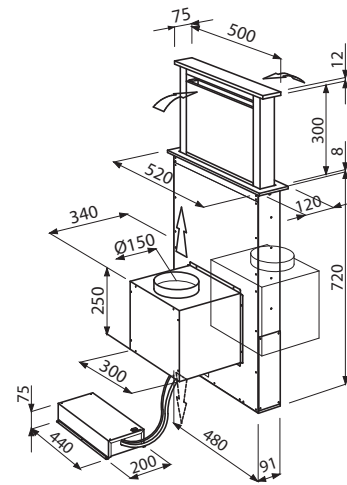

Amélie

2447 090

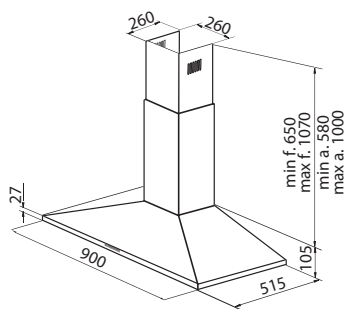

KS NEW

2504 194
2504 394

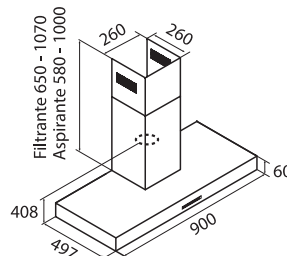

New Wing NEW



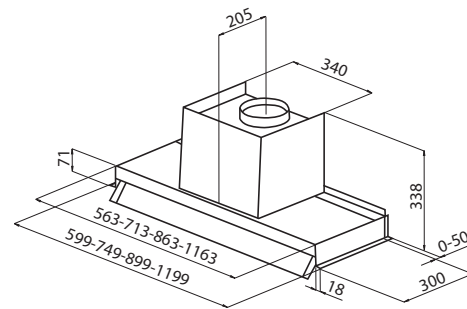



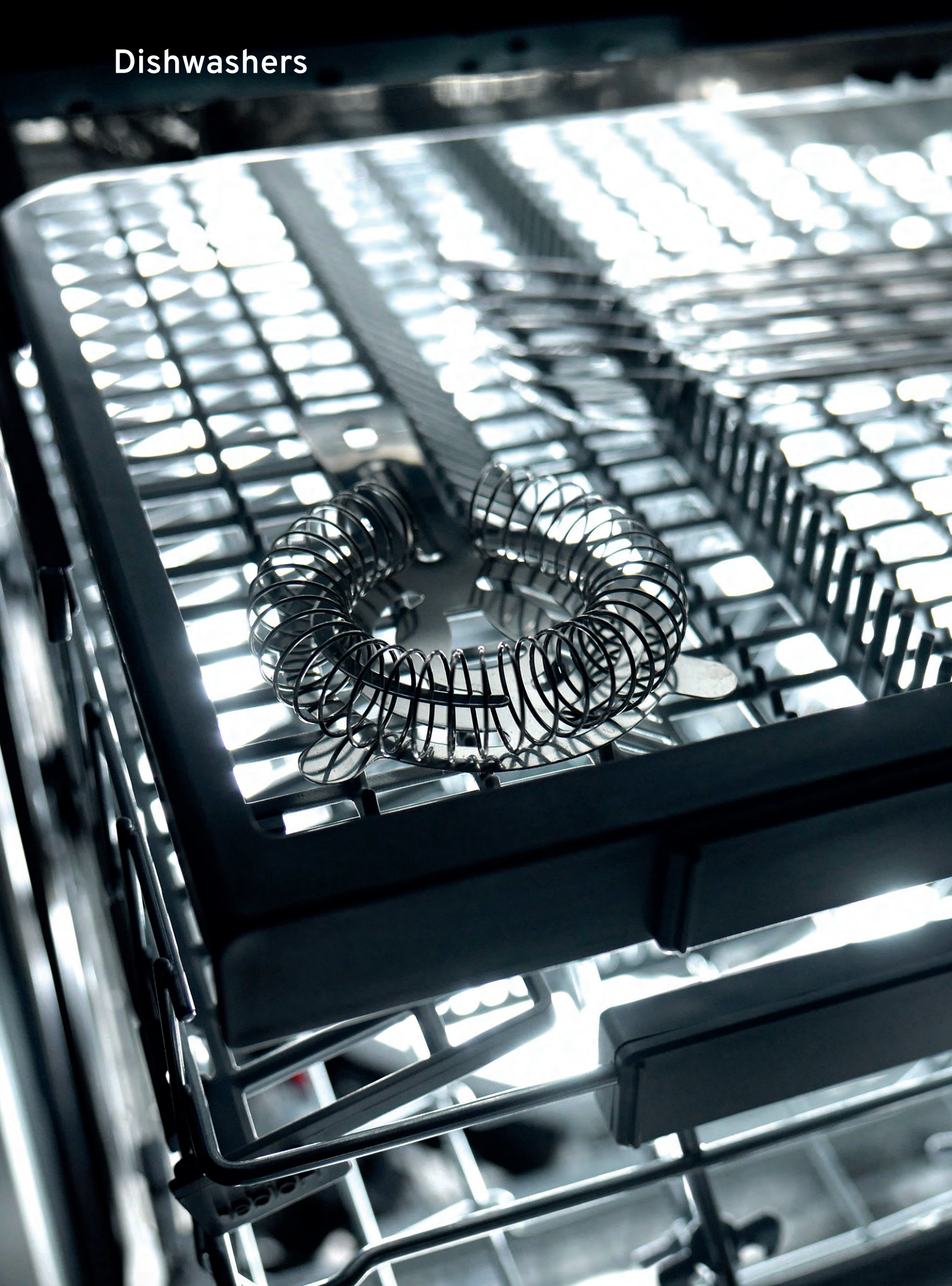



2512 062 60 cm 2512 092 90 cm
2512 072 75 cm 2512 122 120 cm



Dishwashers



Washing functions

-  **Programs**
Set of handy and essential programs and comprehensive, sophisticated programming to suit every need.
-  **Acquastop**
Stops the water supply and prevents leaks and overflows at source. Included on all models.
-  **Adjustable basket**
The upper basket is simple to adjust in height, even when fully loaded.
-  **Extra rapid**
When you're in a hurry, this function reduces the programs' duration, down to the 15' of the rapid program.
-  **Half-load**
Saves time and energy with the half-load setting. Available on all programs.
-  **Total hygiene**
Increases the washing and drying temperatures. Included on all models.
-  **Delayed programming**
It is possible to program a delayed start of the dishwasher, and thus to optimise the energy consumption during the day.
-  **Tabs "All in 1"**
Once it is activated, the washing cycle is adapted to the practical all-in-one tabs instead of the regular detergent.
-  **Place settings**
Thanks to carefully designed layout, Foster dishwashers are very spacious for up to 13 place settings.
-  **Efficiency**
A range that meets the class of quality of the new European regulations.

KS Plus



Characteristics

- Fully built-in dishwashers
- Energy class F
- Number of place settings 13
- Energy consumption 103 kwh/100 ECO cycles
- Water consumption per cycle: 12 litres
- Noise level: 48 dB(A) class C
- Digital panel
- No salt-rinse and shine aid indicator lights
- End of cycle indicator: acoustic + floor light
- Door panel attached with Slider and fixed system
- Front adjustment of back feet
- Feet height 0-70 mm
- Cutlery basket

Optional accessories:

2910 018 Stainless steel door panel (See page 482)

Washing programs

soak, crystals, eco, quick, auto, ultraclean, eco rapid, delicate rapid, daily clean, intensive rapid

Technical data

supply voltage: 220-240 V - 50Hz

Door panel dimensional limits:

Thickness 18-28 mm

Height (with fixed panel) 660-720 mm

Height (with slider panel) 660-770 mm

Plinth dimensions (with slider panel) 50-215 mm

Door panel weight 2.5 - 11 Kg

Code

Price

2941 001

Functions



Technical drawing on page 482



Characteristics

- Fully built-in dishwashers
- Energy class E
- Number of place settings 12
- Energy consumption: 92 kWh/ 100 ECO cycles
- Water consumption per cycle: 12 litres
- Noise level: 47 dB(A) class C
- No salt-rinse and shine aid indicator lights
- Front adjustment of back feet
- Feet height 0-50 mm
- Cutlery basket

Optional accessories:

2910 018 Stainless steel door panel (See page 482)

Washing programs

intensive, pre-wash, quick 30', eco, daily clean.

Technical data

supply voltage: 220-240 V - 50Hz

Door panel dimensional limits:

Height 647-717 mm

Panel weight: 3 - 8 Kg

Code

2950 002

Price

Functions



Technical drawing on page 482

KS Plus

2941 001

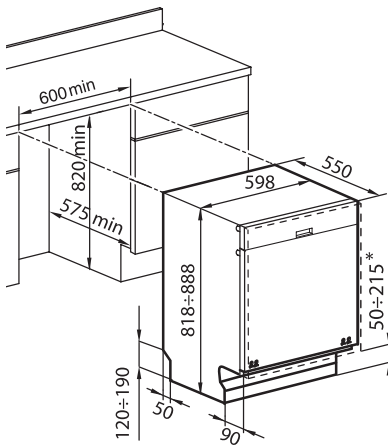

*with slider panel

Elettra

2950 002

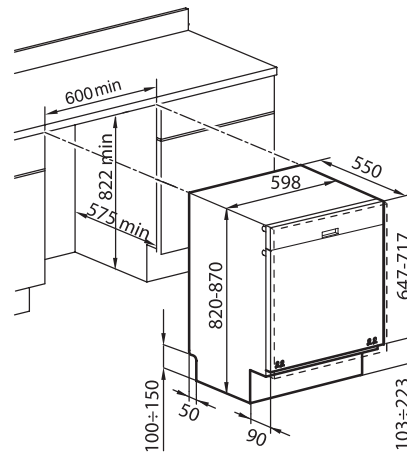

Stainless steel door panel

2910 018



Finish: Satin finish AISI 304

Measurements: 595 x 716 x 20 mm

The integrated handle easily matches any kitchen door.
Compatible with KS Plus and Elettra dishwashers.

Tailor-made solutions

have always been one of Foster's most distinctive features.

To find out about all the possibilities of customised worktops, whether in steel or composite materials, have a look at the technical documentation of the **Foster Group** companies specialising in on-demand solutions.

www.bautek.it and www.fostersurfaces.it

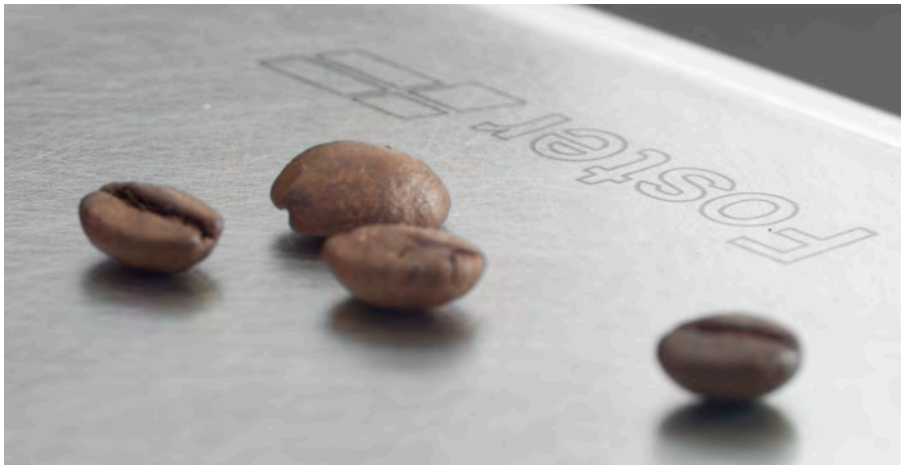

One material, many different looks, thanks to a range of proposals that includes **classic satin finishes**, new **rough** and **matt** treatments and the retro touch of the **Vintage finish**.



Different finishes.

Different profiles and thicknesses.

Freestanding supports.

Endless solutions for every project requirement.

A special worktop by Foster also means the security of **top-quality craftsmanship** and the **guarantee of a single manufacturer** on the entire product.

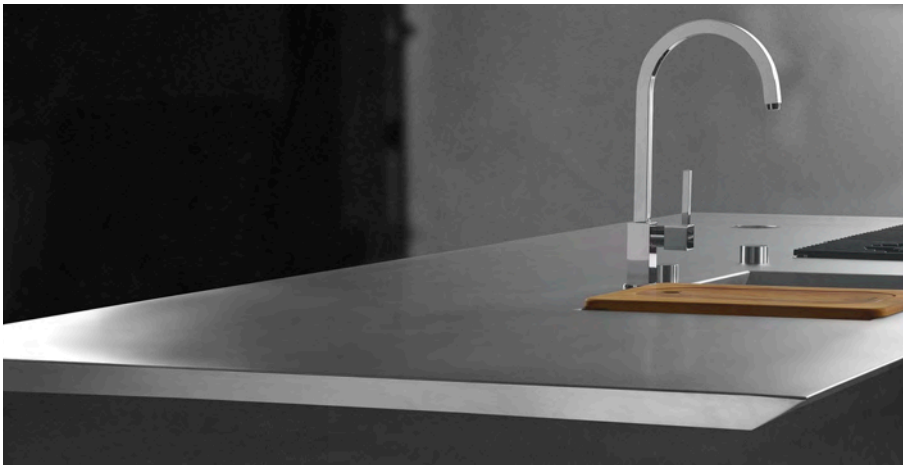

Even what you can't see is important. All of our worktops are made of the finest materials and have an internal structure that makes them freestanding.







Search for products by code

1011 050	111	1130 069	70	1236 050	127	1561 201	185
1012 050	111	1130 860	252	1237 050	127	1561 202	185
1013 850	231	1130 866	29	1250 051	149	1562 001	184
1014 850	230	1130 868	52	1250 052	149	1562 002	184
1015 850	230	1130 869	70	1251 051	149	1579 660	189
1016 850	230	1144 001	199	1251 052	149	1611 060	185
1017 050	110	1144 002	199	1252 051	149	1679 660	189
1017 055	110	1144 061	199	1252 052	149	1679 860	280
1018 050	110	1144 062	199	1254 050	116	1715 015	83
1018 055	110	1179 061	198	1254 056	27	1715 016	28
1024 050	110	1179 062	198	1254 850	236	1715 050	123
1025 050	110	1180 150	202	1254 856	27	1715 055	83
1031 050	105	1180 156	33	1255 050	116	1715 056	28
1031 850	224	1186 161	197	1255 056	26	1715 815	83
1034 050	104	1186 162	197	1255 850	236	1715 816	29
1034 056	25	1197 161	197	1255 856	27	1715 850	242
1034 058	49	1197 162	197	1257 050	116	1715 855	83
1034 059	67	1197 461	197	1257 056	26	1715 856	29
1034 850	224	1197 462	197	1257 850	236	1717 015	82
1034 856	25	1205 050	129	1257 856	26	1717 016	28
1034 858	49	1214 850	249	1279 060	198	1717 050	123
1034 859	67	1215 050	129	1300 068	278	1717 055	82
1040 051	104	1215 850	248	1303 860	282	1717 056	28
1040 052	104	1217 850	248	1410 000	143	1717 815	83
1040 851	224	1218 050	128	1412 000	143	1717 816	28
1040 852	224	1218 850	248	1416 001	143	1717 850	242
1043 051	104	1219 050	128	1416 002	143	1717 855	83
1043 052	104	1220 050	128	1511 001	185	1717 856	28
1129 000	199	1221 050	129	1511 002	185	1718 050	123
1130 060	132	1221 850	249	1513 201	184	1718 850	242
1130 066	29	1229 050	128	1513 202	184	1735 050	122
1130 068	52	1235 050	127	1555 600	188	1737 050	122

1773 100	351	2155 058	50	2157 086	30	2266 080	158
1811 050	278	2155 059	68	2157 840	273	2269 050	159
1812 161	197	2155 080	161	2157 850	267	2269 080	159
1812 162	197	2155 086	30	2157 855	85	2272 050	159
1840 850	283	2155 840	273	2157 856	30	2274 050	159
1845 850	283	2155 850	267	2157 858	50	2278 050	158
1850 850	282	2155 855	85	2157 859	68	2279 050	159
1865 850	276	2155 856	31	2157 880	267	2280 051	157
1870 850	276	2155 858	51	2157 886	30	2280 052	157
1886 160	198	2155 859	69	2157 888	50	2283 050	156
1971 061	179	2155 880	267	2157 889	68	2287 050	156
1971 062	179	2155 886	31	2201 851	267	2297 051	156
1971 961	181	2155 888	51	2201 852	267	2297 052	156
1971 962	181	2155 889	69	2202 851	266	2439 003	468
1972 061	179	2156 050	161	2202 852	266	2440 091	466
1972 062	179	2156 056	32	2203 850	266	2440 121	466
1972 961	181	2156 080	161	2204 851	266	2440 150	465
1972 962	181	2156 086	32	2204 852	266	2440 210	465
1974 060	179	2156 850	268	2205 850	265	2440 300	465
1974 960	181	2156 856	32	2206 850	265	2442 091	466
2151 850	269	2156 858	51	2207 850	265	2442 121	466
2151 856	33	2156 859	69	2211 051	155	2442 150	464
2152 850	269	2156 880	268	2211 052	155	2442 210	464
2153 850	268	2156 886	32	2222 051	155	2442 300	464
2153 856	32	2156 888	51	2222 052	155	2447 090	473
2154 050	161	2156 889	69	2263 051	155	2451 000	472
2154 056	31	2157 050	160	2263 052	155	2451 090	471
2154 850	268	2157 055	84	2264 050	159	2451 120	471
2154 856	31	2157 056	30	2264 080	159	2504 194	474
2155 050	161	2157 058	50	2265 050	159	2504 394	474
2155 055	85	2157 059	68	2265 080	159	2512 062	475
2155 056	30	2157 080	160	2266 050	158	2512 072	475

2512 092	475	3217 000	171	4340 058	48	5554 248	46
2512 122	475	3218 001	171	4340 059	66	5554 249	64
2522 101	469	3218 002	171	4350 001	98	5554 340	213
2522 111	469	3219 051	169	4350 006	23	5554 346	22
2530 001	467	3219 052	169	4350 008	47	5554 348	46
2531 001	467	3274 050	171	4350 009	65	5554 349	64
2910 018	482	3303 060	192	4350 051	218	5555 240	212
2941 001	480	3308 050	192	4350 056	24	5555 246	22
2950 002	481	3352 050	138	4350 058	48	5555 248	46
2975 060	153	3352 850	255	4350 059	66	5555 249	64
2977 060	153	3353 050	139	4371 001	98	5555 340	213
3024 800	347	3353 850	256	4371 006	23	5555 346	22
3024 801	353	3355 050	139	4371 008	47	5555 348	46
3024 880	348	3355 850	256	4371 009	65	5555 349	64
3024 881	354	3356 050	139	4371 051	218	5557 240	212
3025 800	347	3356 850	256	4371 056	23	5557 246	22
3025 801	353	3357 050	138	4371 058	47	5557 248	46
3025 880	348	3357 850	255	4371 059	65	5557 249	64
3025 881	354	3358 050	138	4500 051	165	5557 340	213
3026 800	347	3358 850	255	4500 052	165	5557 346	22
3026 880	348	3363 050	135	4502 050	166	5557 348	46
3135 850	262	3365 050	135	4503 051	165	5557 349	64
3136 850	262	3366 050	135	4503 052	165	5812 061	174
3137 850	262	3367 050	134	4504 051	165	5812 062	174
3138 850	257	3780 000	360	4504 052	165	5886 060	175
3139 850	260	4151 050	147	4505 050	166	7014 032	427
3141 850	260	4340 001	98	5186 061	175	7015 032	427
3143 850	260	4340 006	24	5186 062	175	7016 032	426
3212 051	169	4340 008	48	5197 061	175	7017 032	426
3212 052	169	4340 009	66	5197 062	175	7018 032	427
3216 051	169	4340 051	218	5554 240	212	7038 052	424
3216 052	169	4340 056	24	5554 246	22	7041 632	429

7042 632	429	7278 032	410	7370 300	383	7680 000	405
7043 632	429	7284 042	412	7371 300	382	7680 006	40
7044 632	428	7285 032	413	7373 300	383	7680 008	58
7063 052	423	7286 032	413	7374 300	382	7680 009	76
7066 052	423	7321 240	380	7381 646	375	7682 000	402
7067 062	423	7322 240	380	7382 646	375	7681 000	405
7107 640	447	7322 300	383	7384 646	375	7681 006	40
7107 642	447	7325 455	379	7385 646	376	7681 008	58
7107 646	43	7330 255	378	7386 646	376	7681 009	76
7122 055	453	7341 255	379	7391 245	371	7682 000	402
7126 047	452	7341 655	379	7392 246	369	7682 006	40
7131 057	443	7361 270	387	7600 032	419	7682 008	58
7135 087	443	7362 300	387	7601 032	420	7682 009	76
7136 027	444	7363 350	387	7601 632	42	8000 010	304
7137 000	449	7364 270	389	7601 866	60	8000 011	303
7138 001	444	7365 020	391	7601 932	78	8000 012	303
7141 044	451	7365 030	391	7602 032	419	8000 014	303
7142 045	451	7365 040	391	7603 032	419	8000 015	304
7151 010	453	7365 300	389	7637 000	407	8000 017	304
7193 047	452	7366 020	390	7638 000	407	8000 018	303
7201 032	416	7366 030	390	7638 006	41	8000 020	350
7203 032	417	7366 040	390	7638 008	59	8000 028	305
7206 032	416	7366 350	389	7638 009	77	8000 113	304
7206 082	416	7367 020	389	7639 000	406	8000 115	304
7207 032	417	7367 030	389	7639 006	41	8000 116	42
7208 032	417	7367 040	389	7639 008	59	8000 116	304
7238 042	414	7368 020	387	7639 009	77	8000 117	304
7256 032	409	7368 030	387	7640 000	407	8000 118	304 / 61
7257 032	409	7368 040	387	7640 006	41	8000 119	304 / 79
7259 042	413	7369 020	387 / 389	7640 008	59	8000 214	303
7271 032	409	7369 030	387 / 389	7640 009	77	8000 215	304
7276 032	410	7369 040	387 / 389	7666 062	421	8000 217	304

8000 315	304	8100 703	350	8401 001	300	8407 122	52
8000 317	304	8100 704	351	8402 000	300	8407 122	298
8100 030	293	8100 705	351	8403 000	300	8407 200	300
8100 030	351	8100 706	351	8403 001	300	8410 000	301
8100 037	293	8100 707	356	8403 008	300	8411 000	301
8100 058	350	8100 708	356	8403 014	300	8415 000	301
8100 111	296	8100 709	356	8403 300	300	8416 000	301
8100 112	296	8100 710	351	8403 301	300	8424 100	312
8100 154	295	8100 712	350	8403 303	300	8424 851	88
8100 201	295	8100 714	350	8403 308	300	8424 856	34
8100 280	295	8100 715	356	8403 310	300	8424 858	54
8100 303	295	8119 000	301	8403 311	300	8424 859	72
8100 304	295	8143 000	301	8403 312	300	8425 100	316
8100 305	296	8151 000	297	8403 325	91	8426 000	314
8100 306	296	8151 001	293	8403 325	300	8426 100	314
8100 600	293	8151 003	350	8404 000	300	8426 106	35
8100 602	292	8151 004	356	8407 000	299	8435 000	301
8100 614	292	8151 006	33	8407 100	299	8435 002	301
8100 615	292	8151 008	52	8407 102	299	8435 003	301
8100 617	292	8151 009	70	8407 103	299	8441 000	328
8100 618	292	8151 100	297	8407 108	298	8441 030	328
8100 620	293	8152 100	296	8407 109	298	8442 500	333
8100 621	293	8153 100	296	8407 110	33	8443 002	334
8100 622	293	8154 043	297	8407 110	299	8449 500	333
8100 627	293	8156 000	297	8407 113	299	8458 001	332
8100 628	293	8159 101	295	8407 115	298	8466 000	324
8100 651	292	8320 000	381 / 411	8407 116	298	8466 100	324
8100 652	292	8331 000	305	8407 117	298	8467 000	320
8100 653	292	8331 012	305	8407 120	33	8467 100	320
8100 700	350	8333 000	305	8407 120	298	8471 000	338
8100 701	351	8333 012	305	8407 121	70	8477 100	313
8100 702	351	8401 000	300	8407 121	298	8478 001	337

8480 001	320	8524 000	336	8669 019	300	9700 517	473 / 474
8481 000	332	8524 100	336	8669 026	300	9700 532	373 / 461
8483 001	323	8524 006	38	8669 028	300	9700 533	373 / 461
8484 000	319	8524 008	57	8669 029	300	9700 534	373 / 461
8485 002	329	8524 009	75	8669 030	300	9700 535	373 / 461
8486 000	321	8524 100	336	8669 031	300	9700 536	373 / 461
8487 000	315	8525 000	330	8669 032	300	9700 537	373 / 461
8488 000	318	8530 000	340	8669 033	300	9700 538	373 / 461
8492 000	323	8542 655	293	8669 058	300	9700 539	373 / 461
8493 000	321	8549 000	324	8669 059	300	9700 574	373 / 461
8496 100	322	8550 000	331	8669 066	300	9700 575	373 / 461
8497 000	326	8551 000	331	8669 068	300	9700 577	373
8497 020	325	8611 000	296	8669 069	300	9700 580	373
8497 100	326	8612 000	296	8700 007	300	9700 592	469
8497 400	56	8631 300	297	8700 062	300		
8497 606	327	8633 300	297	8700 080	300		
8497 700	74	8642 000	294	8803 000	369		
8497 856	37	8642 004	294	8803 116	369		
8498 626	326	8643 117	360	8803 118	369		
8498 851	89	8644 003	294	8803 119	369		
8498 856	36	8644 044	294	9601 668	401		
8498 858	55	8644 101	295	9601 727	401		
8498 859	73	8648 002	294	9601 741	401		
8499 000	335	8657 001	294	9601 742	401		
8520 000	340	8659 111	294	9700 001	464 / 465 / 466		
8520 010	341	8660 000	300	9700 221	475		
8520 100	341	8669 000	300	9700 380	467		
8520 856	39	8669 008	300	9700 409	468		
8521 000	317	8669 009	300	9700 450	472		
8522 000	329	8669 011	300	9700 459	472 / 471		
8522 100	329	8669 012	300	9700 460	471		
8523 000	339	8669 018	300	9700 497	471		

Foster Warranties and Customer Care



Foster is an ISO 9001:2015 certified company
Registration number CH-36474

Warranties

All Foster products comply with EEC directives and are covered by Foster's 24-month warranty.

Customer care

We want to give you a product and a service that lives up to your choice, which is why Foster has an extensive network of Technical Service Centres in Italy and abroad.



To ask for support:



Search for and contact an authorised service centre in your area



Contact our customer care by filling in the form on the website

Foster accepts no liability for any inaccuracies or errors and reserves the right to make changes and improvements to the products shown at any time and without prior notice.
Every item in this catalogue is manufactured in compliance with current regulations and EC directives.
The Foster organisation will be happy to provide further details and updates on products and services.

Made in collaboration with DNT Comunicazione and Studio Spazian.

Foster 

Foster Spa
Via M. S. Ottone, 18/20 - 42041 Brescello (RE) Italy
info@fosterspa.com - fosterspa.com